

***EAGLE ONE***

The logo consists of a stylized eagle head in profile, facing right, with its wings spread out horizontally. The entire logo is rendered in a metallic, silver-white color with a slight gradient and a shadow effect, giving it a three-dimensional appearance.

***GOLF PRODUCTS***

# TABLE OF CONTENTS

## SIGNAGE

3

Bronze Signs  
Custom Signs/Tee Signs  
Directional Signs  
Engraved Signs  
Fairway Signs  
FusionCast  
Traffic Signs

## RANGE & PRACTICE

16

Bag Stands  
Ball Bags & Baskets  
Ball Dispensers  
Ball Stackers  
Club Cleaners  
Commercial Ball Washers  
Driving Range Netting  
Practice Green Flags & Cups  
Practice Green Markers  
Range Balls & Storage Containers  
Range Clocks & A-frames  
Range Dividers  
Range Mats  
Range Pickers  
Roller Ball Picker **NEW!**  
Rubber Tees  
Warm-up Cages  
Yardage Poles  
Yardage Signs & Banners

## TEE AREA

44

Ball Wash Detergent  
Ball Washers  
Broken Tee Caddies  
Divot Mix Bottles & Bottle Holders  
Divot Mix Containers  
Score Card Caddies  
Seed Tubes  
Tee Markers  
Towels  
Trash Containers & Litter Caddies

## FAIRWAY

64

Bunker Liner  
Bunker Rakes & Handles  
Cart Directional Barriers  
Cart Path Markers  
Distance & Hazard Markers  
Fairway Drag Nets  
Fairway Snake  
Flex Stakes  
Kirby Markers  
Landscape/Maintenance Rakes  
Mushroom Markers  
Rope & Chain  
Rope Stakes  
Sand Combs  
Speed Bumps  
Sprinkler Yardage Markers  
Traffic Diverters  
Vertical Distance Markers

## GREENS

86

Colossal Cup  
Cup Pullers  
Cup Setters  
Custom & Embroidered Flags  
Depth Gauges  
Dew Whips  
Drag Mats  
Flag Sticks **NEW!**  
FootGolf **NEW!**  
Greens Cups  
Hand Aerifiers  
Hole Cutters  
Hole Groomers  
Hole-in-White  
Lutes  
Placement Flags  
Premier FootGolf  
Prism Gauges  
Reflectors & Top Studs **NEW!**  
Replacement Cutter Shells  
Roller Squeegees  
Shell Sharpeners  
Soil Probes  
Special Event Cups **NEW!**  
Speed Stimp Meters  
Target Rings  
The Klaw Ball Mark Repair Tool  
Turf Levelers

## CLUBHOUSE, PRO SHOP, TOURNAMENT & MINI GOLF

109

Ball Mark Repair Tools  
Ball Spotters  
Cart & Bag Tags  
Cigarette Receptacles  
Compressed Air Cleaners  
Crowd Control  
Golf Bag Storage System **NEW!**  
Message Boards  
Mini Golf  
Neet-Kleet Shoe Cleaners  
PEM Matting  
Pencils  
Rental Pull Carts  
Roll Rubber Matting  
Special Event Recorders  
Spike Brush Cleaners  
Tees

## RECYCLED PLASTICS

122

Adirondack Chairs  
Ash Trays  
Benches  
Cold Beverage Containers  
Dining Tables & Chairs  
Drinking Fountains  
Igloo Coolers  
Lounge Chairs & Sofas  
Phone Boxes  
Picnic Tables  
Planter Boxes  
Recycling Centers  
Starters Consoles & Podiums  
Trash Receptacles  
Tri-Pod Cooler Stands  
Water Cooler Housings

## SAFETY, MAINTENANCE, & IRRIGATION

144

"Powerhead" Trimmers  
2-Way Radios  
Accu-Gauges  
Animal Control  
Brooms  
Byho Edger  
Bypass Loppers  
Control Valves  
Ear Plugs  
Eye Wash Kits & Stations  
Golf Cart Identification  
First Aid Kits  
Fountains  
Gas Cans  
Gloves  
Goggles & Face Shields  
Golf Cart Sand Bottles  
Golf Cart Tires  
GolfCo Rollers  
Gopher Traps  
Hand Pruners  
Hand Saws  
Hand Suction Pumps  
Helmets & Hard Hats  
Hose Swivels  
Hose Taps  
Hoses  
Ice Picks  
Impact Sprinklers  
Leaf Rakes  
Lightning Detectors  
Marking Paint & Turf Chalk  
Marking Wand & Pistol  
Maruyama Power Equipment  
Moisture Sensors  
Overshoes & Boots  
Pellet Pros  
pH Meters  
Profile Nozzles  
Protective Spray Suits  
Quick Coupler Valves & Keys  
Rain Suits  
Reachers  
Respirators  
Rolo Tapes  
Sharpening Compound  
Shears  
Shovels  
Sight Screens  
Sod Knives  
Speed Bumps  
Sprayers  
Spreaders  
Striping Machines  
Sunscreen  
TAS Trimmers,  
Trimmer Blades  
Trimmer Line  
Turf Blankets  
Underhill Irrigation Products  
Watering Nozzles  
Weed Pro  
Wetting Forks  
Wheel Stops

**ALUMINUM FAIRWAY SIGNS**

- 10" x 6" sign face
- 1/8" thick aluminum signs designed and built for years of use.
- Durable, powder coated finish out-performs conventional paint.
- Convenient one-piece construction provides greater durability and allows easy installation.
- Easily customized with your message.
- Double-sided to reduce your costs.
- Double-sided signs with arrows have the direction reversed on the 'back'.
- Other color combinations and languages available - call for details.



Green on White  
**S000W**



White on Green  
**S000G**

- |   |  |
|---|--|
| <b>001</b> Please Keep Off  | <b>027</b> Notice Applying Chemicals Today       |
| <b>002</b> Next Tee   | <b>028</b> Are You Holding Up Play?              |
| <b>005</b> No Chipping  | <b>030</b> Wet Area                              |
| <b>006</b> Park Golf Carts Here   | <b>031</b> No Mulligans                          |
| <b>007</b> Carts (with arrow)   | <b>033</b> Use 90 Degree Rule                    |
| <b>009</b> Carts (bi-directional arrow)   | <b>034</b> Winter Rules                          |
| <b>010</b> No Carts Beyond This Point   | <b>035</b> Summer Rules                          |
| <b>011</b> Keep Carts On Path   | <b>037</b> Please Keep Pace With The Group Ahead |
| <b>012</b> Drop Area  | <b>041</b> Please Rake Bunker                    |
| <b>014</b> Keep Carts 30 Feet From Greens   | <b>042</b> Seeded Area Keep Off                  |
| <b>015</b> Please Replace Divots  | <b>043</b> Frost Delay                           |
| <b>017</b> Ground Under Repair  | <b>044</b> Walk (with arrow)                     |
| <b>018</b> Repair Ball Marks On Green   | <b>045</b> No Carts                              |
| <b>019</b> Putting Green Closed   | <b>050</b> Please Fill Divots With Sand And Seed |
| <b>020</b> After Reaching Green Wave<br>Following Players On                                | <b>052</b> Range Closed                          |
| <b>024</b> Scatter  | <b>053</b> Please Keep Carts In Rough            |
| <b>026</b> Notice You The Golfer Are Responsible For<br>The Consequence Of The Ball You Hit | <b>060</b> Carts On Path This Hole Only          |
|   | <b>061</b> Tee Closed                            |
|   | <b>063</b> Course Closed                         |



Custom signs can be made to your specifications. Please call for pricing and further details.

SIGNAGE

RANGE & PRACTICE

TEE AREA

FAIRWAY

GREENS

CLUBHOUSE, PRO SHOP, & TOURNAMENT

RECYCLED PLASTICS

SAFETY MAINTENANCE, & IRRIGATION

**ENGRAVED LAMINATED PLASTIC FAIRWAY SIGNS WITH METAL SPIKES**

These signs are made from solid two tone sign board. They are a one piece construction that will not rust or need painting, and will withstand the chemicals used in the golf course environment. All signs are single sided except for the directional "carts", "next tee" and "walk" signs. 10"x 6" or 15" x 9" with 4 1/2" spikes.

Our quality signs are made from 3/4" thick material that beats all other competition for a sturdier sign and a finer look.

Color filled custom signs can be made to your specifications. Please call for pricing and further details.



Green on White  
10"x 6"

**SLO00W** Single Sided  
Double Sided



White on Green  
10"x 6"

**SLO00G** Single Sided  
Double Sided



Arrow shaped signs available.  
Please call for pricing and further details.



Green on White  
15"x 9"

**SSL000W** Single Sided  
Double Sided



White on Green  
15"x 9"

**SSL000G** Single Sided  
Double Sided

**ENGRAVED GREENWOOD™ FAIRWAY SIGNS**

You have many choices of engraved GreenWood™ signs. Popular selections are made from 2" x 10" GreenWood™ and 18" long, another is 2" x 6" x 10". All these signs have two metal spikes for support. Apart from being very rugged and good looking, they also convey a "Don't run over me" image that some smaller signs lack. Standard are single sided, but can be made double sided.

**SF001 - SF063**

2" x 6" x 10" Engraved Sign Standard Wording

**SF000C**

Call For Quote

2" x 6" x 10" Custom Engraved Fairway Sign

**SE001 - SE063**

2" x 10" x 18" Engraved Standard Wording

**SE000C**

Call For Quote

2" x 10" x 18" Custom Engraved Fairway Sign



**TRAFFIC SIGNS**

Heavy gauge aluminum informational signs. Highway quality .063" thickness. Many more to choose from or customize. For customizing please call.

SIGNAGE

RANGE & PRACTICE

TEE AREA

FAIRWAY

GREENS

CLUBHOUSE, PRO SHOP, & TOURNAMENT

RECYCLED PLASTICS

SAFETY, MAINTENANCE, & IRRIGATION



**S15412** Stop 12"  
**S15418** Stop 18"  
**S15424** Stop 24"



**S157** Yield 24"x24"



**S167**  
No Parking 12"x12"



**S181**  
Do Not Enter 24"x24"



**S156**  
No Dumping 18"x12"



**S15512**  
No Trespassing 18"x12"



**S16312**  
No Parking Anytime 12"x18"



**S166**  
Valet Parking 12"x18"



**S153**  
Do Not Enter 12"x24"



Carts Crossing  
**S18918** 18"x18"  
**S18924** 24"x24"



Caution Speed Bump  
**S16524** 24"x24"  
**S16512** 12"x12"



**S180**  
Reserved For 18"x24"



**S18612**  
5 Mph 12"x18"



**S18712**  
10 Mph 12"x18"



15 Mph  
**S18812** 12"x18"  
**S18818** 18"x24"



**S168**  
Handicap Parking Only 12"x18"



**S999**  
Custom Sign  
Call For Quote

SIGNAGE  
RANGE & PRACTICE  
TEE AREA  
FAIRWAY  
GREENS  
CLUBHOUSE, PRO SHOP, & TOURNAMENT  
RECYCLED PLASTICS  
SAFETY MAINTENANCE, & IRRIGATION

**GOLF COURSE SIGNS**



**S173**  
Rattlesnakes 12"x12"



**S173A**  
Alligator/Rattlesnakes 12"x12"



**S170**  
Reclaimed Water 12"x12"



**S225**  
Environmentally Sensitive 12"x12"



**S228**  
Ball Mark Repair 18"x18"



**S150IL** - Illinois  
Protectants Applied 12"x12"



**S150WI** - Wisconsin  
Pesticides Applied 12"x12"



**S150KY** - Kentucky  
Regulating Materials 12"x12"



**S171**  
Recycled Products 12"x12"



**S227**  
Weather Warning 12"x12"



**S217**  
90° Rule 12"x12"



**ST10334**  
Player Responsibility 12"x12"



Applying Chemicals  
**S22912** 12"x12"  
**S22918** 18"x18"



**ST10317**  
Chemical Storage 12"x12"



**ST10310**  
Carts On Path 12"x12"



**S197**  
No Carts 18"x18"



**ST10315**  
No Trespassing 12"x12"



**S198**  
Range Closed 18"x18"



**ST10306**  
Course Closed 12"x12"



**S196**  
No Fishing 18"x18"

**GOLF COURSE SIGNS CONTINUED**



**S231**

Front Nine Closed 12"x18"



**S230**

Back Nine Closed 12"x18"



**S220**

Don't Drink The Water 12"x18"



**S169**

Poison Ivy & Poison Oak 12"x18"

Comes with erasable pen



**S195**

Today's Turf Schedule 24"x18"



**S199**

Cart Barriers Scatter Sign 3"x12"

**CLUBHOUSE SIGNS**



**S179**

Unisex Restroom 12"



**S200**

Unisex Restrooms 8"x12"



**S177**

Mens Restroom 12" Triangular



**S178**

Women's Restroom 12" Round



**S201**

Telephone 6"x10"



**S176**

Bag Drop 12"x18"



**S175**

No Smoking 6"x10"



**S17412**

No Tree Watering 12"x12"

SIGNAGE

RANGE & PRACTICE

TEE AREA

FAIRWAY

GREENS

CLUBHOUSE, PRO SHOP, & TOURNAMENT

RECYCLED PLASTICS

SAFETY, MAINTENANCE, & IRRIGATION

## CUSTOM ALUMINUM SIGNS

Need to display a special message or instruction? Let us make up a custom aluminum sign for you. Aluminum is heavy gauge, freeway quality 0.063" gauge thickness. We have many colors to choose from and can include any design or logo. For extra protection and enhanced looks, ask about anti-graffiti film.

**S999** Custom Sign Call For Quote

Standard Sign Sizes:

- |           |           |
|-----------|-----------|
| 12" x 12" | 24" x 24" |
| 12" x 18" | 24" x 30" |
| 12" x 24" | 24" x 36" |
| 12" x 36" |           |
|           | 36" x 36" |
| 18" x 18" | 36" x 48" |
| 18" x 24" |           |
| 18" x 36" |           |



**S226**  
Public St. Crossing  
24" x 24"  
Post Not Included  
Customized Logo Extra



## PEDESTALS



**S302** Sign Pedestal



Stability and an attention to detail are conveyed with this solid pedestal base, with a 5 foot 4" x 4" post.

**S945**

## STEEL POST

Extremely tough, galvanized steel 'U' channel post. Available in 5', 6', 7', 8', 9', 10' and 12' lengths.

- S901-5** 5 Ft.
- S901-6** 6 Ft.
- S901-7** 7 Ft.
- S901-8** 8 Ft.
- S901-9** 9 Ft.
- S901-10** 10 Ft.

Posts over 8' require common carrier shipping.



SIGNAGE  
RANGE & PRACTICE  
TEE AREA  
FAIRWAY  
GREENS  
CLUBHOUSE, PRO SHOP, & TOURNAMENT  
RECYCLED PLASTICS  
SAFETY MAINTENANCE, & IRRIGATION



**GREENWOOD™ SIGN POSTS**

Sign posts made from GreenWood™ are great looking, low maintenance and will last a lifetime. You can choose from 2 x 2, 2 x 4, 4 x 4 and numerous colors.

Price includes attachment to sign at factory.



4" x 4" Posts



2" x 2" Posts

- S92024** Sign Post 2" x 2" Square 24"
- S92032** Sign Post 2" x 2" Square 32"
- S92124** Sign Post 2" x 4" Square 24"
- S92132** Sign Post 2" x 4" Rectangular 32"
- S9223** Sign Post 4" x 4" Square 3'
- S9224** Sign Post 4" x 4" Square 4'
- S9225** Sign Post 4" x 4" Square 5'
- S9226** Sign Post 4" x 4" Square 6'
- S9227** Sign Post 4" x 4" Square 7'
- S9228** Sign Post 4" x 4" Square 8'

**ENGRAVED GREENWOOD™ SIGNS**



These attractive signs are made to your specifications and needs. We have many GreenWood™ selections and color choices to choose from. The engraved groove is backfilled with special resins of your color choice to create the copy. Please speak to our sales team for more information and guidance.

**S930** 3/4" Boards Call For Quote

**LAMINATED PLASTIC  
A-FRAME SIGN**

These dual color A-frame signs are made of a durable, stain resistant, laminated sign board. Messages can be engraved to highlight core color or color filled for your preferred font appearance. Other features include a handsome engraved outline running along the outer edges of this sign allowing it to "pop" and a convenient handle near the top. 23" Wide x 36" High. Please see next page for color choices.

**S975** Call For Quote



**ENGRAVED LAMINATED PLASTIC SIGNS**

If you are looking for low maintenance signs this is the answer. Using laminated layers of different colored plastic, the copy or logo is engraved through the upper surface to expose the next color. These signs can be made in large sizes and will withstand beatings by golf clubs, balls and many of the typical vandal problems regularly encountered.

Standard sign size:

- 12"x12"
- 12"x18"
- 18"x18"
- 18"x24"
- 24"x24"
- 24"x36"
- 36"x36"
- 36"x48"



**S960**

Engraved Laminated Sign  
Call For Quote

**CUSTOM BACK-FILLED ENGRAVED LAMINATED PLASTIC SIGNS**

Add more color to your custom signs with our new color fill option. This allows for limitless multi color options on your sign.

**S961** Call For Quote



Clocks can be added to any sign.



**LAMINATED PLASTIC COLOR CHOICES**

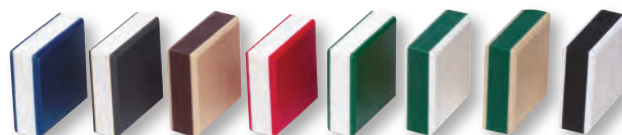

SIGNAGE  
RANGE & PRACTICE  
TEE AREA  
FAIRWAY  
GREENS  
CLUBHOUSE, PRO SHOP, & TOURNAMENT  
RECYCLED PLASTICS  
SAFETY MAINTENANCE, & IRRIGATION

**ENGRAVED LAMINATED PLASTIC TEE SIGNS**

If you are looking for low maintenance these signs are the answer. Using laminated layers of different colored plastic, the copy or logo is engraved through the upper surface to expose the next color. These signs can be made in large sizes and will withstand beatings by golf clubs, balls and many other vandal problems regularly encountered. Color choices on opposite page show layout encased with 1/4" clear plastic drop-in panel.

There are also decorative shape signs which conveys a sense of craftsmanship and timelessness. A matching base completes this classic theme. Enhancements can include the addition of a lexan-protected hole layout and engraved color filled fonts for a complete look.

**S980ST**

Engraved Laminated Single Post Signs 18" x 36"  
Call For Quote

**S980DT**

Engraved Laminated Double Posted Signs  
Call For Quote



**MOVEABLE HARD  
SURFACE SIGNS**

Do you have a need for a sign that can be moved around on a hard surface? Then this unit may be helpful. Using our laminated plastic signs attached to a GreenWood™ A-shaped support bracket, this sign becomes extremely durable and flexible to use. Size can be made to your specifications.

**S962** 18"x24" Sign

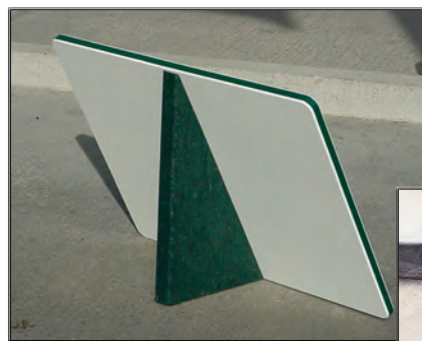

SIGNAGE

RANGE &  
PRACTICE

TEE AREA

FAIRWAY

GREENS

CLUBHOUSE,  
PRO SHOP, &  
TOURNAMENT

RECYCLED  
PLASTICS

SAFETY,  
MAINTENANCE,  
& IRRIGATION

**SINGLE POSTED ALUMINUM FACED TEE SIGNS**

Low maintenance 100% GreenWood™ 4" x 4" post and 2" or 3/4" backing board. Available in multiple colors. Sign face is heavy gauge aluminum. Customized to your design. Coated with anti-graffiti sheeting. Economical and good looking. Vandal resistant. Sign face can easily be replaced if yardages or information changes.

- S940S** Aluminum Faced, Single Post Tee Sign Call For Quote
- S940L** Aluminum Faced, Single Post Tee Sign - Long Call For Quote
- S940DL** Aluminum Face With Pattern/Decoration Call For Quote

Sign Sizes:

- 8" x 17"
- 8" x 23"
- 8" x 30"
- 10" x 24"
- 12" x 34"
- 18" x 20"
- 18" x 36"



**TWO POSTED ALUMINUM TEE SIGNS**

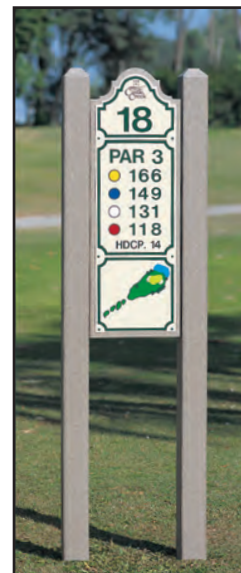
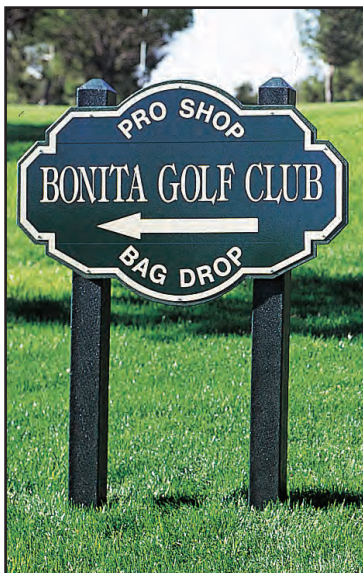

- S950** Double Posted Tee Sign with Anti-Graffiti Call For Quote

SIGNAGE  
RANGE & PRACTICE  
TEE AREA  
FAIRWAY  
GREENS  
CLUBHOUSE, PRO SHOP, & TOURNAMENT  
RECYCLED PLASTICS  
SAFETY MAINTENANCE, & IRRIGATION

**6" X 6" POST TEE SIGN**

Here is a simple classy looking tee sign. Made of our 100% GreenWood™ these 6" x 6" posts can be engraved and color filled to meet your needs.



**S939S**

6' Post  
Call For Quote

**S939L**

8' Post  
Call For Quote

**ADJUSTABLE DRIVING RANGE SIGNS**

If you move your tee line often then these signs allow you to keep the distances accurate. Aluminum number plaques slide into channels to create the correct distance. Posts are durable GreenWood™ and sign face is either heavy duty aluminum with vinyl graphics or backfilled engraved laminated plastic. Custom logos and layouts are not a problem.



Set of numbers included:  
8 Zeros, 6 Ones, 4 Twos,  
4 Threes, 4 Fours, 8 Fives  
4 Sixes, 4 Sevens  
4 Eights, 4 Nines

**S995A** Aluminum Sign, GreenWood™ Legs  
Call For Quote

**S997A** Laminated Plastic Sign, GreenWood™ Legs  
Call For Quote



**CART DECALS**

Identify your course marshal or assistant. Signs can be selected from either vinyl transfer or plastic board.

PLEASE NOTE: The vinyl transfer is like a sticker. If you are looking for a transferable sign, please order the PVC board.

**S309V** "Marshal" Decal On Vinyl Sticker

**S309P** "Marshal" Decal On PVC

**S310V** "Players Assistance" Decal On Vinyl Sticker

**S310P** "Players Assistance" Decal On PVC

**DIGITAL BANNERS**



Promote your course, driving range or event with a custom banner. We have a wide selection of colors and sizes to choose from. Heavy duty vinyl banners last well and remain fresh looking for a long time.

**SCBANNER** Call For Quote



SIGNAGE

RANGE & PRACTICE

TEE AREA

FAIRWAY

GREENS

CLUBHOUSE, PRO SHOP, & TOURNAMENT

RECYCLED PLASTICS

SAFETY, MAINTENANCE, & IRRIGATION

**FusionCast™**  
ENGINEERED METAL CASTING TECHNOLOGY



## SIGN TYPES



TEE SIGNAGE



PRACTICE FACILITY SIGNAGE



SPONSOR PLAQUES



PARKING LOT/ STREET SIGNAGE

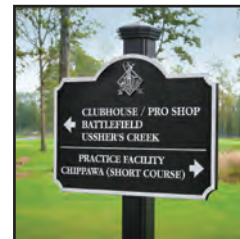

DIRECTIONAL SIGNAGE



CLUBHOUSE SIGNAGE



ENTRANCE SIGNAGE



CLUB CHAMPION/ DEDICATION SIGNAGE

CUSTOM LOGOS CAN BE ADDED TO ANY SIGN

Covering Your Course...From Entrance to Exit!  
More **COST EFFECTIVE** than Bronze  
More **PRESTIGIOUS** than Acrylic  
More **DURABLE** than Wood, **LIGHTER** than Granite

FUSCUSTOM Call For Quote

## TEE SIGN GUIDE

SHAPE OPTIONS

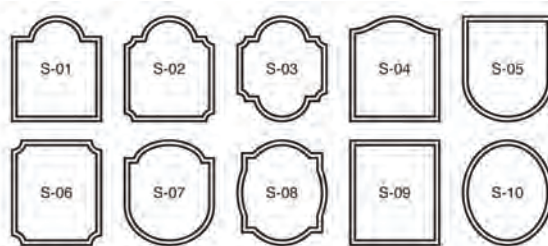

TEXTURE OPTIONS

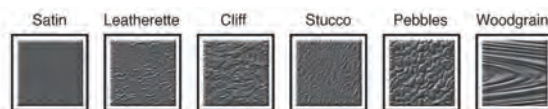

## COLOR OPTIONS



## MOUNTING OPTIONS

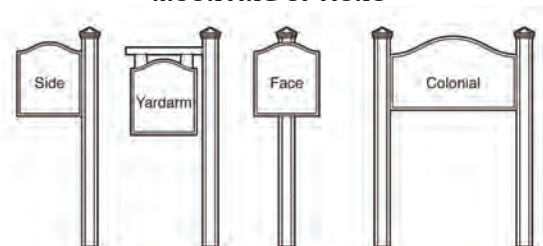

SIGNAGE  
RANGE & PRACTICE  
TEE AREA  
FAIRWAY  
GREENS  
CLUBHOUSE, PRO SHOP, & TOURNAMENT  
RECYCLED PLASTICS  
SAFETY MAINTENANCE, & IRRIGATION



**FusionCast™**  
ENGINEERED METAL CASTING TECHNOLOGY

Eagle One is the exclusive distributor  
of Fusion Cast to the U.S.  
Complete customization available.



### A revolutionary new metal casting technology

We use a cold casting process that results in highly customizable, durable and lightweight signage products. The process is eco-friendly and best of all, more economical than other cast metal methods. Our signs, plaques and related signage products provide an endless array of possibilities for any application (indoors and out).

### BRONZE / CAST ALUMINUM TEE SIGNS

If you are looking for a sign that exemplifies the rich traditions of golf, then Eagle One has something for you. Each sign is designed and cast to your exact specifications with the highest quality craftsmanship. A wide variety of styles and background colors are available as well as many mounting options. With very little maintenance bronze signage can actually look better with age and last a lifetime.

Use bronze and cast aluminum for course condition signs, directional signs, tee markers (see Tee Area section), plaques, fairway markers (see Fairway section), and other specialty markers.

- S971** Bronze
- S972** Aluminum
- S973** Powder Coated Aluminum Sign Post



SIGNAGE  
RANGE & PRACTICE  
TEE AREA  
FAIRWAY  
GREENS  
CLUBHOUSE, PRO SHOP, & TOURNAMENT  
RECYCLED PLASTICS  
SAFETY MAINTENANCE, & IRRIGATION



**ARCH DESIGN DELUXE CLOCK**

Our newest range clock has an oversized deluxe clock mounted on laminated plastic backer board with GreenWood™ trim and legs. Virtually maintenance free this great clock will look good anywhere on your course.

**P009**  
Arch Design Deluxe Clock

**P011**  
Classic Arch Design Deluxe Clock



**OVERSIZED MOVEABLE "A" FRAME RANGE SIGN**

This oversized range sign is easy to read on even wide ranges. Interchangeable numbers can be changed as the hitting line moves. Made of super durable laminated plastic with color filled targets. Many options are available, call to discuss.

**P250**  
Oversized Moveable Range Sign  
Call For Quote



Customization available with your logo!



**A-FRAME CLOCK**



12" clock on a 17"x 23" A-frame. A variety of colors available for frame.

**P010** Single  
**P0102** Double

**REPLACEMENT CLOCKS**



**P006CLOCK**  
Replacement 12" Clock



**P009CLOCK**  
Replacement Stainless Steel 18" Clock

If you move your tee line on a regular basis this sign is a necessity. By using an erasable pen on a vinyl sheeted aluminum face and GreenWood™ frame you can write "TODAY'S" yardage quickly and easily. This accurate distance information will be greatly appreciated by your patrons. Sign is single-sided. Pen Not Included.

**S935**  
No Logo

**ERASABLE "A" FRAME YARDAGE SIGN**







**CLOCKS ON POST**

Comes on a 4"x4" post with a recycled plastic base that can be secured with spikes. Available with a 12" clock and 18" Deluxe Clock.

- P006P** 12" Clock
- P009P** 18" Deluxe Clock



**A-FRAMES**

Help keep your players on time. These two choices of clock units are made from low maintenance GreenWood™ frames with your choice of weather proof 12" or 18" clocks. The "A" frame can be folded up for easy carrying or storage while the post type has four spikes for support by pressing into turf.



Fabricated using plastic as the support frame, these 'A' frame clocks has a clean and neat appearance. Customized to your needs - your course / range logo, driving range distance key or other information can be incorporated the way you want it (at extra cost). Double sided clocks are available, and there are many plastic colors to choose from.

- P007** A-Frame Clock Call For Quote
- P008** Plastic A-Frame Clock With Ipe' Wood Frame Call For Quote

**STYLE OPTIONS**

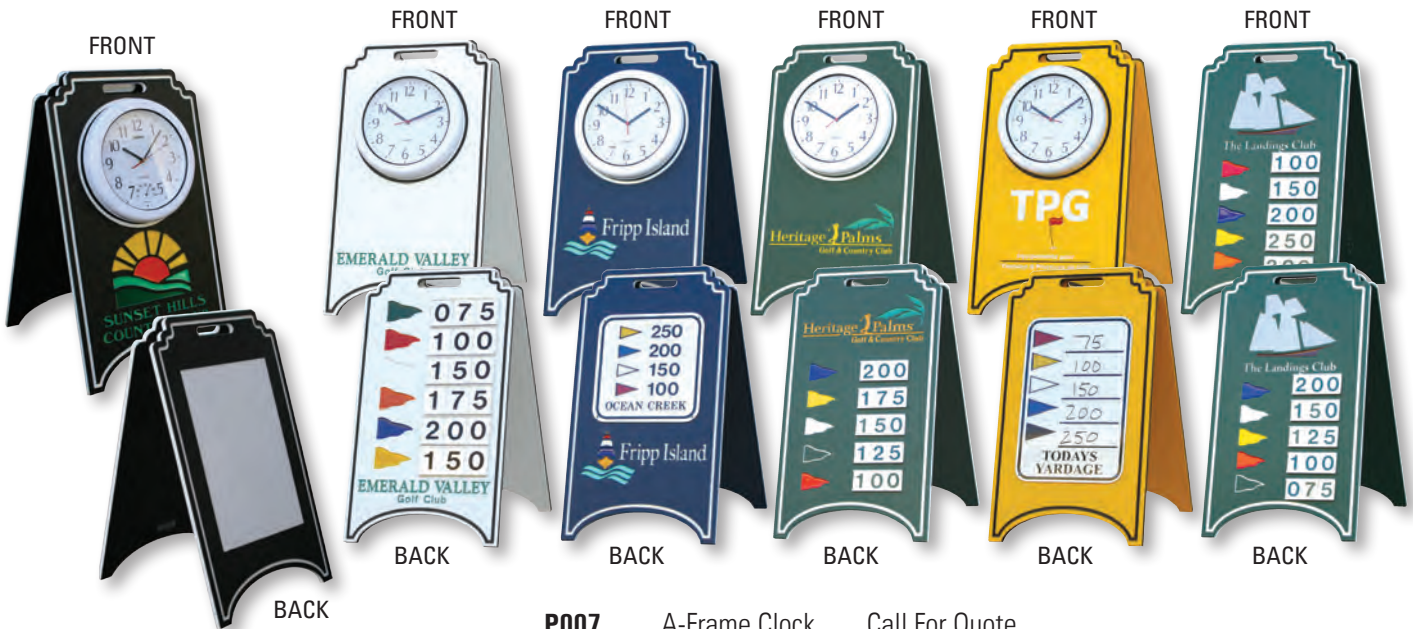

**P007** A-Frame Clock Call For Quote

SIGNAGE  
RANGE & PRACTICE  
TEE AREA  
FAIRWAY  
GREENS  
CLUBHOUSE, PRO SHOP, & TOURNAMENT  
RECYCLED PLASTICS  
SAFETY MAINTENANCE, & IRRIGATION



**THE "SWITCHBACK"  
RANGE MATE® FRONT WHEEL  
BALL PICKER**

- Easy assembly
- Reinforced elbows
- Heavy duty 1½" Sq. steel tubing
- Superior disc material formulated to prevent breakage
- Adjustable and replaceable steel ball combs
- Adjustable axle brackets
- All parts plated to resist rust and corrosion
- Designed to operate with any golf cart
- Attachment brackets available for most golf carts
- Balls ejected into rear mounted baskets

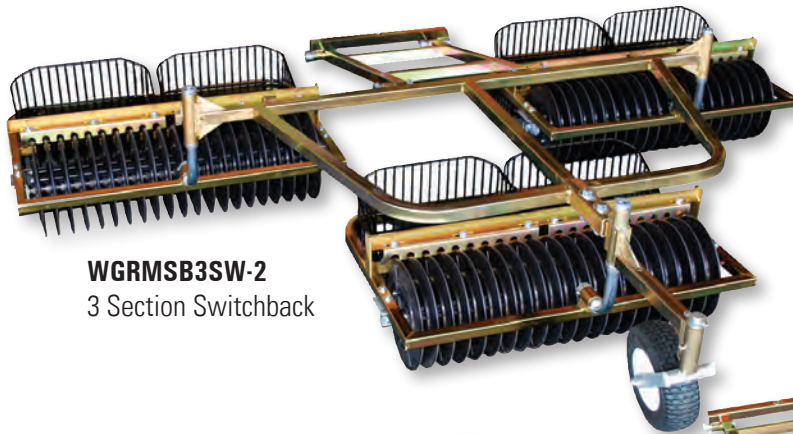

**WGRMSB3SW-2**  
3 Section Switchback

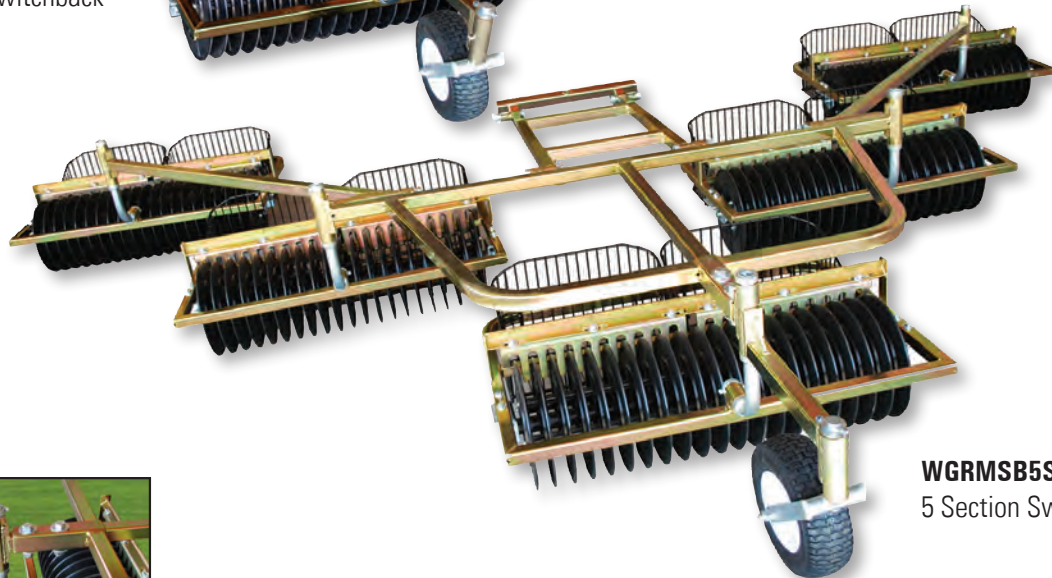

**WGRMSB5SW-2**  
5 Section Switchback



Fig. 1



Fig. 2

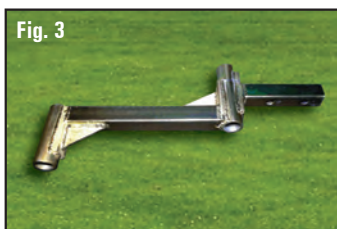

Fig. 3

**NO DOWN TIME! SWITCH FROM WHEELED, TO NO-WHEEL AND BACK AGAIN.**

Western Golf has developed a new golf ball picker which combines the best features of our no-wheel and wheeled units. We have named the new picker the "Switchback" for its ability to switch from wheeled, to no-wheel and back again.

The "Switchback" uses our no-wheel, rear ejection drum sections in both the wheeled and no-wheel configurations. This unique design incorporates a part we call a "receiver," used for either the wheeled or no-wheel picker, that bolts into the main frame. (Figure 3)

When using the wheeled set up, (Figure 1) a receiver consisting of the elbow, fork and wheel assembly is bolted into the main frame. By using no-wheel drum sections, if there is ever a problem with the wheel, tire, bearings or fork, simply remove the nut and bolt in the top collar of the fork, pull out the entire fork assembly and continue running the picker as a no-wheel unit. (Figure 2) Repairs can then be made to the wheel assembly with no down time to the picker. After repairs are made to the wheel assembly, replace the fork in the receiver and switchback to the wheeled unit.

**WGRMSB002**

Switchback Fork, Elbow Receiver



**RANGE MATE NO WHEEL BALL PICKER**



**WGRMSB3S-2**  
3 Section No Wheel

- Easy assembly
- Reinforced elbows
- Heavy duty 1½" Sq. steel tubing
- Superior disc material formulated to prevent breakage
- Adjustable and replaceable steel ball combs
- Adjustable axle brackets
- All parts plated to resist rust and corrosion
- Designed to operate with any golf cart
- Attachment brackets available for most golf carts
- Balls ejected into rear mounted baskets

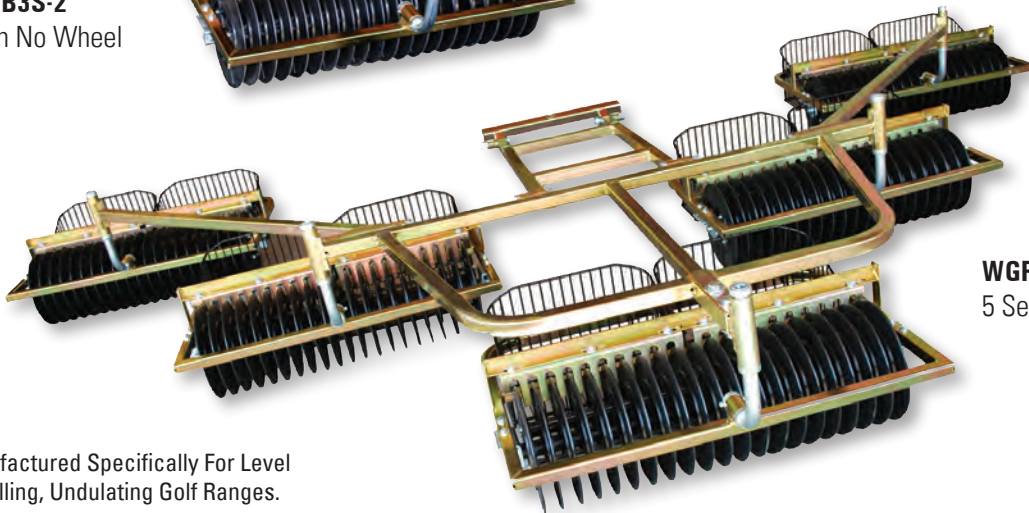

**WGRMSB5S-2**  
5 Section No Wheel

Manufactured Specifically For Level  
To Rolling, Undulating Golf Ranges.



**VIRTUALLY NO MAINTENANCE!**

If a customer orders a no wheel picker, we will ship the "no wheel receiver" installed in the main frame.

Western Golf has also changed to a thicker wall on all tube connections on the main frame, mount bar, and extension arms. Gussets have been added for even more strength at all critical connection points.



**WGRMSB003**  
No Wheel Elbow Receiver



**WGRM024AB**  
Adjustable Axle Bracket



**WGRM036**  
Nylon Discs

SIGNAGE  
RANGE & PRACTICE  
TEE AREA  
FAIRWAY  
GREENS  
CLUBHOUSE, PRO SHOP, & TOURNAMENT  
RECYCLED PLASTICS  
SAFETY, MAINTENANCE, & IRRIGATION



## RANGE MATE HT™

Engineered for Hilly Terrain Virtually No Maintenance

- Sections contour undulating terrain retrieving balls on hill sides and level ground.
- Our Range Mate™ in line design makes this the most maneuverable picker on the market today.
- Designed to operate with any golf cart or tractor, attachment brackets are available.
- Durable nylon discs are standard on the Hilly Terrain Ball Picker.
- Baskets hold 250 balls each.
- Lightweight



**WRHT3S-2** 3-Section with Deflector  
**WRHT302S-2** 3-Section with Mini Frames

Size: 18' Wide 3 Section      Ball Capacity 1,500 Balls      Weight 380 lbs.

SIGNAGE

RANGE & PRACTICE

TEE AREA

FAIRWAY

GREENS

CLUBHOUSE, PRO SHOP, & TOURNAMENT

RECYCLED PLASTICS

SAFETY MAINTENANCE, & IRRIGATION

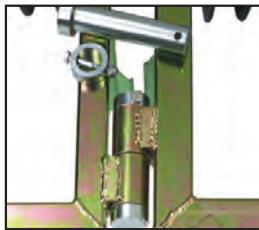

### EXCLUSIVE HINGE AND FRAME CONNECTOR SYSTEM

Ideal for ease of maintenance. All parts gold irradiate plated to resist rust and corrosion



### SPLIT BASKETS ARE STANDARD ON ALL PICKERS.

### PLASTIC BALL DEFLECTORS

Standard on the Hilly Terrain ball picker. Ensures that balls deflect to drums from between drum frames.

**WGRA027**

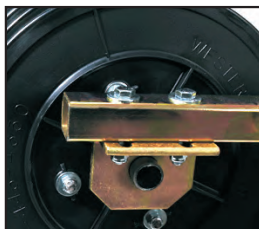

### ADJUSTABLE AXLE BOLTS

These bolts allow for simple disc adjustments and removal.

**WGRM024B**



### BALL COMBS

Adjustable and replaceable. Combs may be removed for straightening or alignment to prevent damage to discs and balls.

**WGRM025A** No Wheel  
**WGRM025** With Wheel

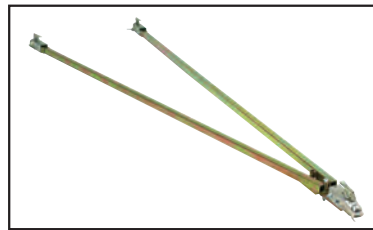

### A-FRAME

Adjustable A-Frame for Hilly Terrain Ball Picker

**WRHT030** 8'  
**WRHT050** 9.5'

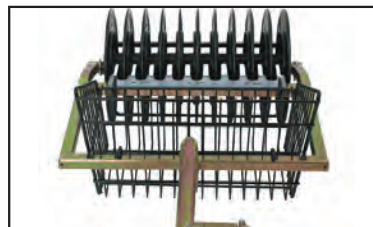

### MINI FRAME

Designed to cover the gap between drum frames. Increases ball capacity and picking efficiency.

**WRHT020**

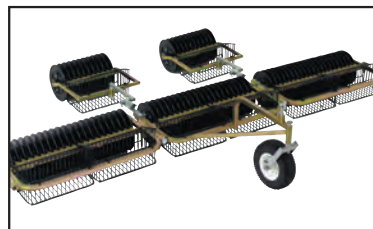

### 3 SECTION HILLY TERRAIN BALL PICKER WITH MINI FRAMES

Picker with mini frames

**WRHT302S-2**



### 3 SECTION HILLY TERRAIN BALL PICKER

Size: 9' Wide Weight: 380 lbs (Shown with Nylon Disc)

**WRHT3S-2**

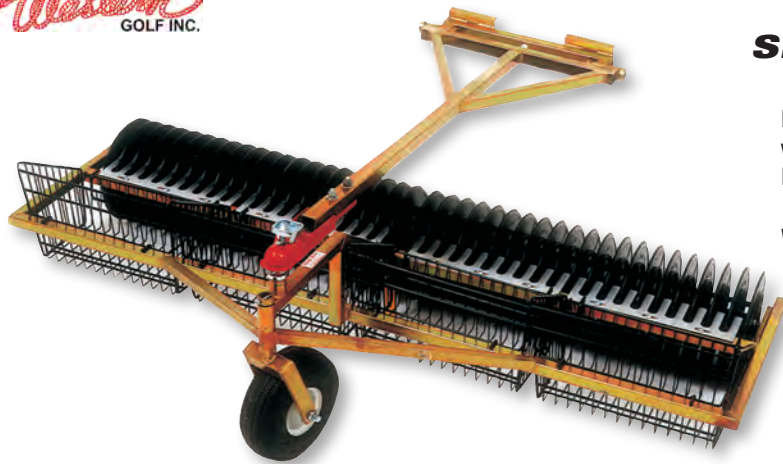

**SINGLE SECTION BALL PICKER**

Designed specifically for budget conscious range owners who want to utilize an electric cart for picking their ranges. Holds 1000 balls. 1 Section 6' overall width, wt. 175 lbs.

**WGRM2SW**

**RANGE MATE®  
3' HAND PUSHED  
PICKER**

An economical hand picker for hard to pick areas or makeshift fairway ranges. 3' picking area, adjustable handle. Holds 400 balls. Wt. 60 lbs.

**WGRM830**



**MINI MATE**

Constructed from 1" square tubing. Picks up balls along fence line and practice areas. Basket holds 250 balls. wt. 40 lbs.

**WGRM800**

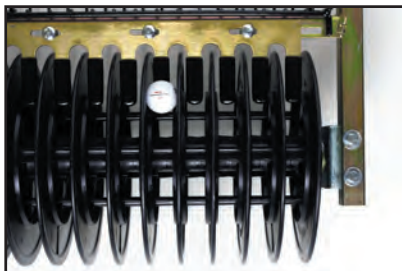

**COMB CUSHION**

Soft contact with the range ball. Comb Cushions are available as an option on all pickers.

**WGRM025C**



**ELBOW**

Heavy duty DOM tubular steel.

**WGRM005** No Wheel Elbow  
**WGRM005W** Wheel Elbow



**FRONT WHEEL**

**WGRM013** Fork Carrier  
**WRHT015C** Large Fork Complete  
**WGRM016** Tire Complete  
**WGRM014** Tongue Connector

SIGNAGE

RANGE &  
PRACTICE

TEE AREA

FAIRWAY

GREENS

CLUBHOUSE,  
PRO SHOP, &  
TOURNAMENT

RECYCLED  
PLASTICS

SAFETY,  
MAINTENANCE,  
& IRRIGATION



**REPLACEMENT DISCS**

High tech material and design make these discs virtually unbreakable. Installation time is about 5 minutes! Save time, labor, and continued replacement costs! Replacement drums available for a variety of pickers. Let us know about your picker.

**WGRM021N** Western 21 Disk Drum

- |  |  |                |
|--|--|----------------|
| <b>WGEZ21N</b> Easy-Picker Section 21 Disc       | <b>WGWK22N</b> Wittek Drum 3 ft. w/ axle 22 Disc | Call for Quote |
| <b>WGRM028N</b> Innovator 23 Disc                | <b>WGHR32</b> Hollrock Drum 5 ft. w/ axle Disc   | Call for Quote |
| <b>WGWK34N</b> Wittek Drum 5 ft. w/ axle 34 Disc | <b>WGHR21N</b> Hollrock Drum Section 21 Disc     | Call for Quote |

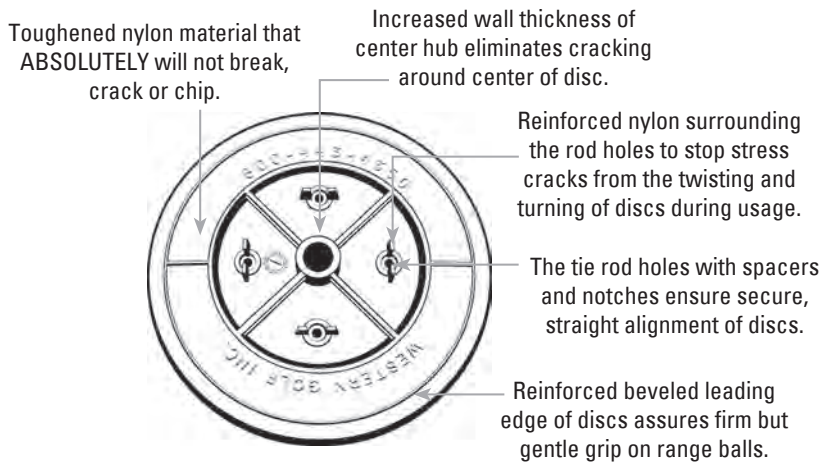

**REPLACEMENT PICKER BASKETS**



**RANGE MATE**  
Holds 250 balls,  
Weight 7 lbs. each  
**WGRM020S**

**EASY PICKER**  
Split Basket, Green,  
Holds 250 balls  
**WGEZ020S**

All original equipment manufacturers names and part numbers are used for identification purposes only. We are in no way implying that any of our products are original equipment parts. Prices are subject to change without notice.

**CART MOUNTING BRACKETS FOR WHEEL AND NO WHEEL BALL PICKERS**

Please specify year and model.



EZ Go (2001 & Newer)  
Workhorse MPT, 24 Lbs.  
Also fits Cushman 1200 Series  
**WGWP20K**



Club Car Bracket, 26 lbs.  
**WGWP23**

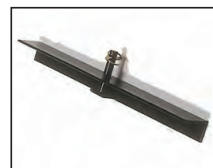

Universal Bracket, 12 lbs.  
**WGWP27**



Yamaha Cart Adapter Bracket, 22 lbs.  
**WGWP24**

**CART MOUNTING BRACKETS FOR HILLY TERRAIN A-FRAME BALL PICKERS**



EZ GO - 3 Bolt 25 lbs.  
**WGWP20W-A**



EZ GO - 4 Bolt 25 lbs.  
**WGWP20-A**



Club Car 27 lbs.  
**WGWP23-A**



Yamaha 23 lbs.  
**WGWP24-A**



Universal 14 lbs.  
**WGWP27-A**



Gator 26 lbs.  
**WGWP35-A**

SIGNAGE  
RANGE & PRACTICE  
TEE AREA  
FAIRWAY  
GREENS  
CLUBHOUSE, PRO SHOP, & TOURNAMENT  
RECYCLED PLASTICS  
SAFETY MAINTENANCE, & IRRIGATION



**RANGE MATE® 3000 BALL WASHER**



- Washes an entire 3 section picker load of balls in under 8 minutes
- Roto molded polyethylene body
- Direct drive, high torque gear motor
- Ball rotates 360° while being gently washed between rubber liners. It has no steel spiral to wear the ball covers.

- Available in 110 or 220 volt
- Vibrator motor attached to wire hopper (on 110 volt units)
- Large 1 1/2" drain and cap
- Wt.: 140 lbs., Size: 44" x 23" x 41"

**WGRMW 3000**

Extra Capacity hopper holds 1200 balls

Replaceable nylon brush

Removable bottom tray and replaceable rubber liners for easy maintenance.

Both the nylon brush and bottom tray lift straight up for easy maintenance

Nylon bearings designed to run in water.

10" solid wheels



**RMW2-30** Optional Stand Only

RM 3000 Replacement Parts:

- RMW2-04** Brush with Shaft
- RMW2-05** Drive Coupling (2pc/Set)
- RMW2-06** Nylon Quick Release Bearings (2 Needed)
- RMW2-03** Rubber Liner Set (Top & Bottom) with Fasteners
- RMW2-07** Vibrator Motor
- RMW2-25** Drain Nipple
- WRCW-21** Drain Cap

SIGNAGE  
RANGE & PRACTICE  
TEE AREA  
FAIRWAY  
GREENS  
CLUBHOUSE, PRO SHOP, & TOURNAMENT  
RECYCLED PLASTICS  
SAFETY, MAINTENANCE, & IRRIGATION

**RANGE MATE® COMPACT BALL WASHER**

**Reliability!  
Durability!  
Speed!  
Price!**



**WRCW2001**

- Washes 20,000 balls per hour
- 1/3 hp motor, belt drive
- Ball rotates 360° while being gently washed between rubber liners and brush
- Easy care design
- Large 1½" drain
- Roto molded polyethylene body
- Available 110 volt or 220 volt
- Hopper holds 1,200 balls
- Weight: 110 lbs, Size: 40" x 23" x 44"

**RM Compact Replacement Parts:**

- WRCW-02** Brush with Shaft
- WRCW-05** Small Motor Pulley System 110V
- WRCW-06N** Nylon Bearing Complete w/  
Bronze Insert/Collar & Washer
- WRCW-07** Rubber Liner Set (Top & Bottom)  
with Fasteners
- WRCW-03** Drive Belt
- RMW2-07** Vibrator Motor

**Easy To Remove Belt  
Driven Brush Shaft**

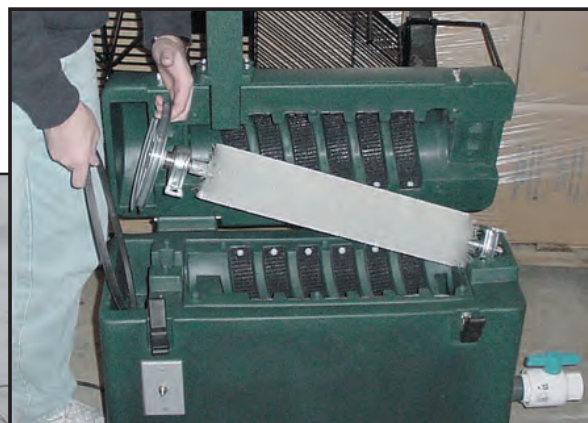

SIGNAGE  
RANGE & PRACTICE  
TEE AREA  
FAIRWAY  
GREENS  
CLUBHOUSE, PRO SHOP, & TOURNAMENT  
RECYCLED PLASTICS  
SAFETY MAINTENANCE, & IRRIGATION



**RANGE ROVER HEAVY DUTY  
BALL PICKER**



**PW72003**  
3 Gang

**PW72005**  
5 Gang

**50G JUNIOR BALL WASHER**

The Junior Ball Washer has the same features as the 50G SuperWash, but the ball hopper holds 350 balls and the tank holds 8 gallons. Powered by a 1.4 HP motor.



**PW73650**  
Brush Lined Drum

**GOLF BALL BRIGHT**

For use in your range ball washer machines this great product has a low sudsing action, speeds drying process, breaks electrostatic bond of dirt/sand off ball, has a fresh scent and odor preventative.



- P1861** Ball Bright 32oz.
- P1864** Ball Bright 4 X 32oz
- P1862** Ball Bright 2.5 Gallon Bladder Box
- P1865** Ball Bright 5 Gallon Bladder Box
- P18612** Ball Bright 12 X 32 Oz Case



**1700 SERIES BALL DISPENSER**

- **ACCOUNTABILITY.** Our ball dispensers provide features and benefits far beyond other models. Account management, sales tracking, and cash accountability are just a few of the operational tools to help you evaluate, analyze, and control driving range ball sales.
- **FLEXIBILITY.** Utilizing our one-ball-at-a-time vending, you have the ability to deliver any number of balls in up to three bucket sizes. This means you can effectively boost sales by configuring a bucket pricing structure best suited to your facility.
- **CONVENIENCE.** By offering multiple payment options and locating the ball dispenser near the tee line your customer may conveniently make additional purchases. For the operator, this means increased sales revenue and a reduction in operating costs.
- Customized payment options: PIN, e-key, cash, and credit card.
- 11,000 ball capacity (optional 5,000 ball extension available).
- Three independent vend sizes.
- Vends eleven balls per second.



**VENDING**

Payment options are e-Keys, cash, and credit card.



**DISPENSING MECHANISM**

Jam-free vending that is able to dispense one ball at a time!

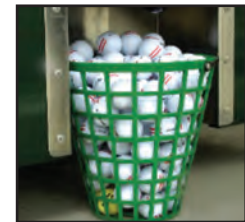

**ANY BALL COUNT**

Programmable to dispense any three bucket sizes.

	<b>OPTIONS &amp; PRICING</b>	<b>RGLD1700T 1700 Series</b>	<b>RGLD1700EV8 1700 Series</b>
<b>STATS</b>	Ball Capacity	11,000	11,000
	Dimensions (in.)	42 W x 37 D x 83¾ H	42 W x 37 D x 83¾ H
	Bucket Selections Available	1	Up to 3
	Programmable Ball Count	X	X
	Token Acceptor	X	
	PIN Key Pad		X
	e-key Reader		X
	PC Interface		X
<b>OPTIONS</b>	Front or Rear Load Capabilities	X	X
	5,000 ball Extension Cabinet additional clearance required	X	X
	e-keys (quantity discounts available)	X	X
	Bill Acceptor		X
	Credit Card Reader	X	X

SIGNAGE  
RANGE & PRACTICE  
TEE AREA  
FAIRWAY  
GREENS  
CLUBHOUSE, PRO SHOP, & TOURNAMENT  
RECYCLED PLASTICS  
SAFETY MAINTENANCE, & IRRIGATION



## Why e-Range PLUS?

e-Range PLUS provides a wired range system that continues working even if your computer or communication fails. Unlike other wired systems that stop working if the computer fails; e-Range lets your customers continue using your automatic tees and ball dispensers.

- Instantly get or set prices and other ball dispenser information from the office.
- Check the status or condition of the ball dispensers from the office.
- Confirm that the ball dispenser is working correctly from the office.
- Get instant, up-to-date, customer account and sales records.
- Cards are obsolete. e-Keys are almost indestructible, and last 5 years at least.

Instantly convert any single size dispenser to 3 sizes.  
Works in any ball dispenser display!



**WGB7801-17**  
**e-Keys**

e-Range PLUS is the best Range Investment YOU could make!

New e-Range PLUS software!  
Even easier to use:

- e-Range version 8 PLUS software is required for PIN use in more than one ball dispenser.
- e-Range PLUS requires a communication cable from the dispensers to a computer.
- e-Range PLUS V4, V6, and Version 8 systems have a range of 4000 feet.
- e-Range PLUS is not computer dependant. If your computer fails, the system still works!

### Credit value used by each system

	e-Range VSD 3 digit Display WGB7800-2	e-Range Ver 4.0 WGB7800-3	e-Range Ver 6.0 WGB7800-4	e-Range Ver 8.0 WGB7800-5
	Basket	Money	Money	Money
3 Selection Sizes - 3 Prices	X	X	X	X
Revalue Customer e-keys	X	X	X	X
Erase and re-use customer eKeys 1000's times	X	X	X	X
Read eKey balances	X	X	X	X
Revalue Software (Revalue Station on PC)	X	X	X	X
Set an expiry date for each individual account		X	X	X
CLUB Key option with Automatic revalue		X	X	X
CLUB Key revalue amount by customer		X	X	X
Data carrier to download events from the reader		X	X	X
View up-to-date customer balances		X	X	X
Void (blacklist) lost or stolen accounts		X	X	X
Replace lost or stolen accounts		X	X	X
View & Print Transaction (event) reports			X	X
View & Print by customer, type, event...			X	X
View & Print Downloaded transactions			X	X
View & Print Monthly Sales Graphs			X	X
View & Print Weekly Sales Graphs			X	X
Print up-to-date customer balances			X	X
Set a discount for each individual account (NEW 2003)			X	X
Export reports to your favorite spreadsheet (NEW 2003)			X	X
e-mail reports (NEW 2003)			X	X
Generate a single use PIN				X
Print Single Customer PIN receipt.				X
Print batches of PINs for group or tournament play (NEW 2003)				X
PIN expiry time from 5 minutes to midnight				X
Free 60 day eRange V8.0 Trial		X	X	

SIGNAGE  
RANGE & PRACTICE  
TEE AREA  
FAIRWAY  
GREENS  
CLUBHOUSE, PRO SHOP, & TOURNAMENT  
RECYCLED PLASTICS  
SAFETY MAINTENANCE, & IRRIGATION

**PLASTIC HORIZONTAL MARKERS**



**P083**

These could quite possibly be the most durable and attractive yardage markers available. Made from two tone 3/4" solid plastic. The numbers are routed down in the face so they can't be destroyed. Color face choices include red, white, blue, green and yellow. Each sign comes complete with 4" x 4" posts with two metal spikes in each. This allows for easy removal and replacement if needed. There are many stock colors available, however, due to the numerous color and number combinations, this item may have to be made to order. Please specify your color and number requirements when ordering. Boards are 47" wide and 30" high.



**PLASTIC VERTICAL YARDAGE MARKERS**

Made from two tone 3/4" solid plastic. The numbers are routed down in the face so they can't be destroyed. Color face choices include red, white, blue, green, and yellow. Each sign comes complete with heavy gauge galvanized steel posts. There are many stock colors available, however, due to the numerous color and number combinations, this item may have to be made to order. Please specify your color and number requirements when ordering.

**P08260** 12" x 60" with 8' post

**DURABLE VINYL RANGE BANNERS**

Heavy-duty ventilating vinyl banner with contrasting numbers of your choice. PVC pipe frame and Ground Sleeve's sold separately.

**P0702**

Yardage Marker Range Banner 2'X4' - Yellow/Black

**P0712W**

PVC Tube Kit 2'X4'



**TARGET NET**



This highly visible net is 5' in diameter and made from a heavy duty, long lasting vinyl mesh material. Frame is durable maintenance free GreenWood™ with an aluminum ring holding the netting in place. Numbers can be customized to your requirements. The net has a "drain" hole to allow golf balls to fall through to a bucket for easy collection. (Bucket not Included.)

**P212**

**DRYRAINGE COVER**

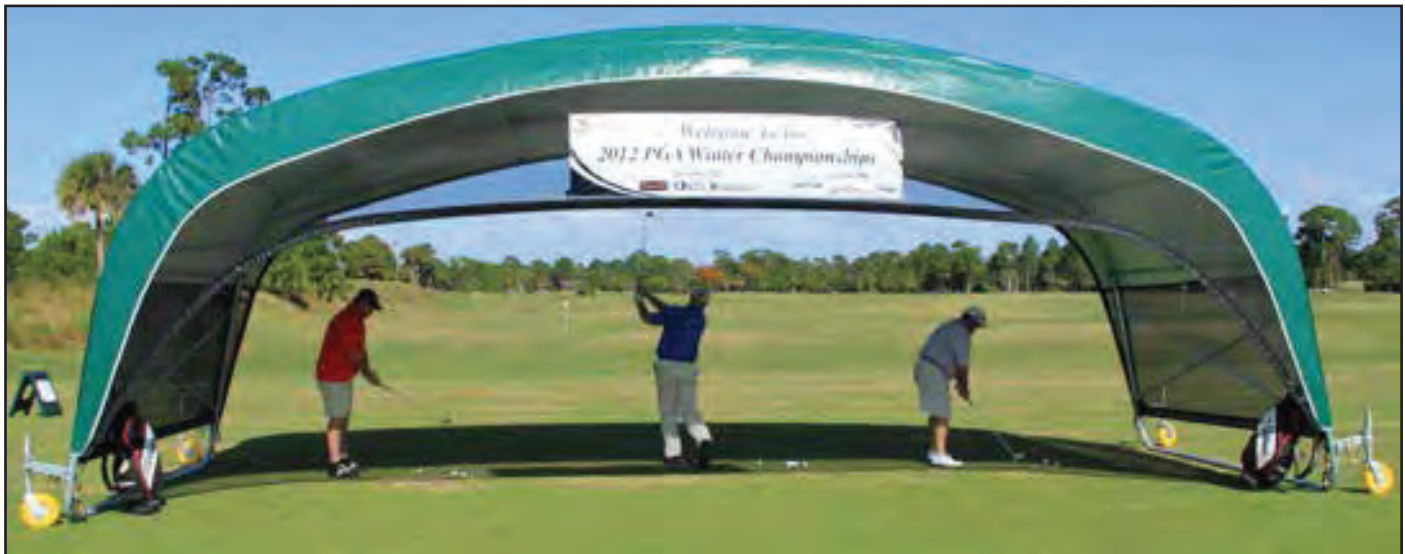

- Provides protection from both inclement weather, as well as prolonged exposure to sun.
- Allows you to optimize your revenue from teaching/instruction regardless of the weather
- Make lessons more comfortable and more productive for both you and your students

- With increased lesson revenue, payback/R.O.I is fast, but protection from prolonged sun exposure is invaluable
- Available both "with" and "without" the optional wheel package (which allows Dryrainge to be moved in/out of position on your range)
- A leasing program for the Dryrainge is also available
- Dimensions: 33' wide, 12' deep, 11'10" high

**P032WK** 3 Man with Wheel Kit

**P032S** 3 Man Stationary

SIGNAGE

RANGE & PRACTICE

TEE AREA

FAIRWAY

GREENS

CLUBHOUSE, PRO SHOP, & TOURNAMENT

RECYCLED PLASTICS

SAFETY, MAINTENANCE, & IRRIGATION

SIGNAGE  
RANGE & PRACTICE  
TEE AREA  
FAIRWAY  
GREENS  
CLUBHOUSE, PRO SHOP, & TOURNAMENT  
RECYCLED PLASTICS  
SAFETY MAINTENANCE, & IRRIGATION



**Barrier Netting**  
Netting and hardware for any size installation available in polyester.  
Custom built with rope border or stock sizes.

**POLYESTER NETTING**

This 7/8" square mesh net is heavier duty than the P021 and is ideal for complete driving ranges or closer range areas. All orders are custom sizes and can be supplied with or without rope borders.

**P005** Exterior Polyester Call For Quote

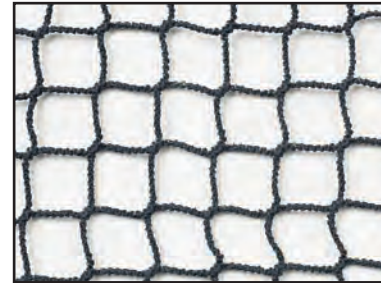

**POLYPROPYLENE NETTING**

This economical net is ideal for driving ranges and as a pond liner for ball retrieval. Easy installation.



Standard-Econo 50lb. Break 150 lb. Burst

SKU	SIZE	WEIGHT
<b>P021</b>	6.5' x 150'	10 lbs
<b>P021-100</b>	25' x 100'	27 lbs
<b>P021-150</b>	25' x 150'	40 lbs

Barrier Netting 75lb. Break 225 lb. Burst

SKU	SIZE	WEIGHT
<b>P021-HD</b>	6.5' x150'	19 lbs
<b>P021-100HD</b>	25' x 100'	58 lbs
<b>P021-150HD</b>	25' x 150'	75 lbs
<b>P021-50X100HD</b>	50' x 100'	100 lbs
<b>P021-50X150HD</b>	50' x 150'	150 lbs



**WARM UP CAGE**

The Pro-Cage net utilizes a polycarbonate frame, while the Pro-Cage net features heavy duty netting with a steel frame. Perfect for year round use indoors or outdoors. The Pro-Cage comes with the net built in one piece with rope edges and a baffle stitched into both the sides and top, velcro straps wrap around the net and frame for quick set up and take down. 10' x 10' x 10'.

**P031** Pro-Cage

**GREENWOOD™  
MINI CONTAINER**

Another great way to use our popular T305M is for storing balls on the range. Made of 100% GreenWood™ this product will require little if any maintenance and will hold approximately 280 dozen range balls. 30" x 21" x 26".

**T305M**



**STACKABLE BALL CRATES**

Use these stackable crates for hauling and storage needs. A must for every driving range operation. Extra for logo.

**P299S**

Small Stackable Crate  
13" x 13" x 11"  
Holds 360 balls



**P299L**

Large Stackable Crate  
19" x 13" x 11 1/2"  
Holds 540 balls



**PLASTIC BALL BASKETS**



These baskets are made of heavy gauge plastic for durability. They are light weight and stackable. Available in three sizes, 40 ball, 70 ball, 100 ball, 150 ball and 350 balls. Colors are Green, Yellow, White and Black.

- P18040** 40 Balls
- P18070** 70 Balls
- P180100** 100 Balls
- P180150** 150 Balls
- P180350** 350 Balls

Please Specify Color When Ordering

**RANGE BASKET STACKER**

Maintain a well managed image at your range with this durable unit. Functional placements include your tee line, ball dispenser or even your maintenance cart. Impervious to the elements, this stacker consists of a GreenWood™ base and rust-free aluminum rods. Please call for color availability. Baskets not included.

**P179**



## RANGE BALL BAGS

**A** Stackable Cordura, 1000 denier, one piece construction, single draw string with cord lock and brass grommet. Red or green, custom screen printing available.

- P17025** 25 - 30 balls
- P17040** 40 - 45 balls
- P17060** 60 - 65 balls
- P17090** 90 - 95 balls



Custom logos available. Please call for quote.

**B** Cotton twill with double drawstring and brass grommets. Red or green, custom screen printing available.

- P17125** 25 - 30 balls
- P17140** 40 - 45 balls
- P17160** 60 - 65 balls
- P17190** 90 - 95 balls



**C** Polyester mesh, single draw string with cord lock available in: blue, green, yellow and black.

- P17220** 20 - 25 balls
- P17240** 35 - 40 balls
- P17260** 50 - 55 balls
- P17290** 95 - 100 balls



Please Specify Color When Ordering.

## THE PYRAMID BALL STACKER

This ball stacker conveniently loads from the top. It is fabricated out of galvanized steel with a choice of either steel or ABS plastic trays. Five size choices are available including: 55 balls, 91 balls, 140 balls, 204 balls, and 285 balls.

- P003285S** 285 Ball Pyramid Stacker Metal
- P003285MT** 285 Ball Metal Tray
- P003204S** 204 Ball Pyramid Stacker Metal
- P003204MT** 204 Ball Metal Tray
- P003204PT** 204 Ball Plastic Tray
- P003140S** 140 Ball Pyramid Stacker Metal
- P003140MT** 140 Ball Metal Tray
- P003140PT** 140 Ball Plastic Tray
- P00391S** 91 Ball Pyramid Stacker Metal
- P00391MT** 91 Ball Metal Tray
- P00391PT** 91 Ball Plastic Tray
- P00355S** 55 Ball Pyramid Stacker Metal
- P00355MT** 55 Ball Metal Tray
- P00355PT** 55 Ball Plastic Tray



SIGNAGE  
RANGE & PRACTICE  
TEE AREA  
FAIRWAY  
GREENS  
CLUBHOUSE, PRO SHOP, & TOURNAMENT  
RECYCLED PLASTICS  
SAFETY MAINTENANCE, & IRRIGATION



**RANGE GOLF BALLS**

All balls consist of two part dupont Lithium Surlyn™ construction with 432 dimples each. Standard color is white. Our controlled distance range balls travel 80% of regular balls and are suited for undersized ranges. Ordered per dozen. Please call for quote.

**GOLF BALL DYE**

Red, White, and Blue dye available for your striping needs.

**WK7520**



**P400R**  
Driving Range Balls



**P400CD**  
Driving Range Balls  
Controlled Distance



**P400F**  
Driving Range Balls  
Floaters



**P400YR**  
Driving Range  
Balls Yellow



**P400YF**  
Driving Range Balls  
Floaters Yellow

**BALL RAKER**

This light weight tool is a great aid for the golf pro. Made from PVC tube and with a roller action, the Ball Raker will quickly round up balls on your practice greens. Includes a unique rolling mechanism allowing the raker to glide easily across your practice greens.

**P230**



**ROLLER BALL PICKER**

Make collecting balls and cleaning up practice areas quick and easy with the Rolling Ball Picker. Lightweight, compact and easy to use, it replaces heavy, bulky PVC collectors and shag bags that hold fewer golf balls and can easily damage greens.

- Hold up to 80 golf balls.
- 50-inch wooden handle.
- Head features 60 metal spokes that separate with little effort when collecting balls.
- Balls are easily removed by separating the spokes.



**PAR10755**



**ORIGINAL  
BAG SHAG**

Durable canvas bag, easy grip handle, heavy duty zipper, stainless steel spring for no fall out. Holds 70 balls. Available in green and black.

**P184BK**  
Black

**P184G**  
Green



**BALLSHAG™**

Designed to pick up 23 balls, this tool is ideal for those hard to get places where machines can't. Made from durable aluminum it is perfect for along fences or tall grass etc.

**P183**



**OPEN TOP  
SHAG BAG**

Similar to the "original" bag shag this has an open top to allow easier dumping of balls. The easier dumping makes it better suited to teaching professionals who are constantly using it and do not need to store the shag with balls in it.

**P182**

SIGNAGE

RANGE &  
PRACTICE

TEE AREA

FAIRWAY

GREENS

CLUBHOUSE,  
PRO SHOP, &  
TOURNAMENT

RECYCLED  
PLASTICS

SAFETY,  
MAINTENANCE,  
& IRRIGATION

**DUAL TURF MAT**

This fantastic mat has a blend of two different lengths of knitted nylon turf height. This blended combination reduces club head resistance offering a more realistic hitting surface. 59" x 59" with four pre-drilled holes to accept rubber tees.

**P040SDT**

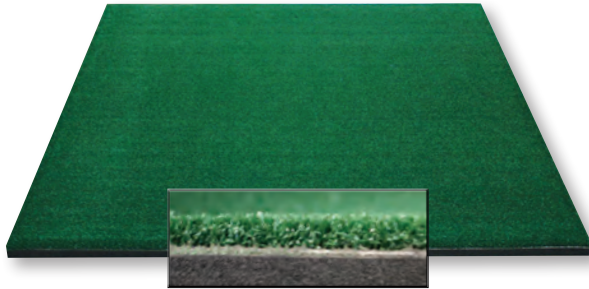

**EAGLE ONE ECONOMY MAT**

This Eagle One Economy Mat has been tested to be durable and long lasting. The range mat is 5' x 5' with 4 different tee locations manufactured using a thick nylon top with a foam base for ideal hitting comfort.

**P040S**

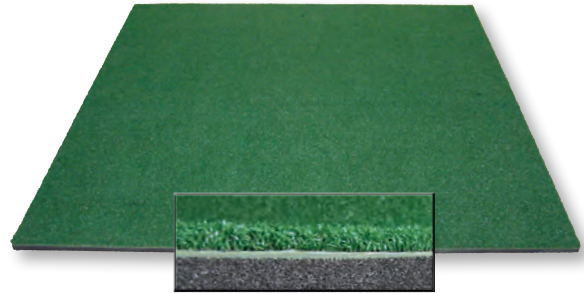

**ULTRA MAT**

The AstroTurf Ultra Mat is made of tough nylon grass blades, with a knitted fabric and cushion pad system designed to absorb club head shock. Ultra Mats remain resilient and resist fatigue stroke after stroke.

**P049S**

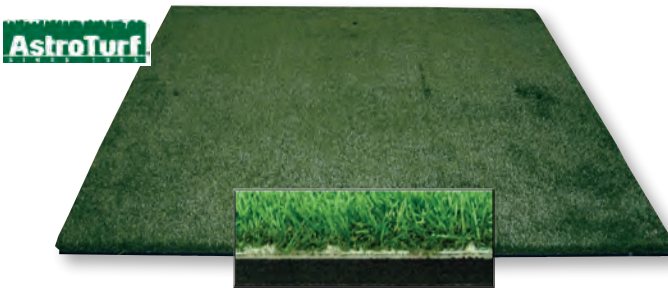

**TRUE-TO-TURF MAT**

Looking for a mat that will accept standard wooden tees? This mat provides the feel of hitting off of a lush fairway, plus it affords the user the ability to use standard wood tees when hitting driver. 59" x 59" with four pre drilled holes.

**P042**

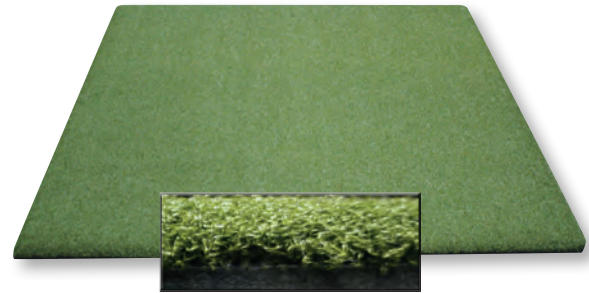

QUANTITY DISCOUNTS AVAILABLE FOR ALL MATS.

**REPLACEMENT RUBBER TEES**



- P06011/2** 1 1/2"
- P06013/4** 1 3/4"
- P0602** 2"
- P06021/4** 2 1/4"
- P06021/2** 2 1/2"
- P06023/4** 2 3/4"
- P0603** 3"
- P06031/4** 3 1/4"
- P06031/2** 3 1/2"

**ADJUSTABLE TEE HOLDER**

This tee allows a regular wood or plastic tee to sit down in it. The beauty of this is you can now adjust the tee height to your usual position for consistency of practice.



- 1" Adjustable Wooden Tee Holder **P0611**
- 1 1/4" Adjustable Wooden Tee Holder **P06111/4**
- 1 1/2" Adjustable Wooden Tee Holder **P06111/2**
- 2" Adjustable Wooden Tee Holder **P0612**

SIGNAGE  
RANGE & PRACTICE  
TEE AREA  
FAIRWAY  
GREENS  
CLUBHOUSE, PRO SHOP, & TOURNAMENT  
RECYCLED PLASTICS  
SAFETY MAINTENANCE, & IRRIGATION

**PRACTICE BALL TRAYS**

This durable ball tray holds practice balls at the mat on driving ranges. It is made from clean looking and long lasting plastic.

**P036** Plastic Ball Tray

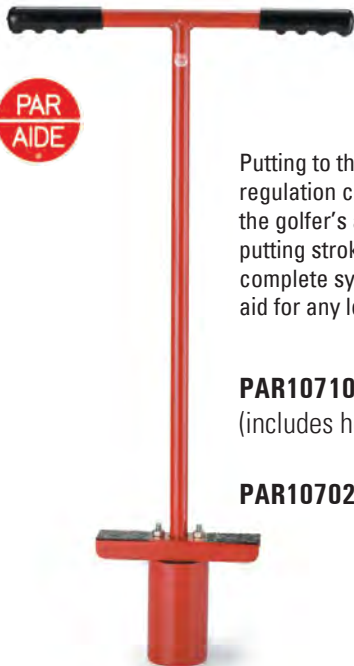

**SURE PUTT™ PRACTICE GREEN SYSTEM**

Putting to the smaller cup, 3 in. diameter compared to a regulation cup of 4-1/4 in. diameter, dramatically helps focus the golfer's aim and trains them to make a more accurate putting stroke. The Sure Putt Practice Green System is a complete system that is widely regarded as the finest putting aid for any level of golfer.

**PAR10710** Complete Sure Putt System (includes hole cutter, 3 cups, sign and cup puller)

**PAR10702** Putting cup only

- Offered at a tremendous value, it includes:
- A Hole Cutter designed to cut a 3 in. (8 cm) wide by 3.5 in. (9 cm) deep hole.
  - 3 putting cups, 3 in. (8 cm) x 3.5 in. (9 cm).
  - Cup Puller.
  - A sign to explain how the system works.



Improved Cup Design

**PRACTICE CUPS**

Durable Bright White plastic cup featuring minimum taper for a snug fit. Meets all USGA regulations. 940 4 in. (10 cm) Practice Cup

**PAR940** Plastic

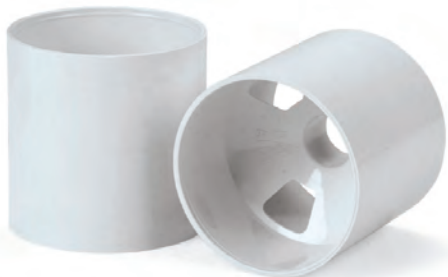

**PRACTICE CUPS**

Sturdy aluminum construction powder-coated white for good visibility. This new cup has a beveled bottom edge making inserting and removing much easier.

**ST18150** Aluminum Cup (shown)

**ST18100** Plastic Practice Cup



**PRACTICE GREENS CUPS**

Greens cup is 4 1/2" high and made of cast aluminum powder coated white.

**P160AL** Aluminum

**P160** Plastic



SIGNAGE  
RANGE & PRACTICE  
TEE AREA  
FAIRWAY  
GREENS  
CLUBHOUSE, PRO SHOP, & TOURNAMENT  
RECYCLED PLASTICS  
SAFETY, MAINTENANCE, & IRRIGATION

**PUTTING MARKERS**

Here is a clean and distinctive look! The heads are made from solid two tone laminated plastic that will not rust or need painting. Numbered style is permanently engraved and if a logo is desired, it is slightly recessed. Numbers or logo are on both sides. Poles can be striped for added decoration at an additional charge. Shaft is 1/2" diameter fiberglass rod.

Custom Round Heads



Numbered Round Head

**SPIKE BASE**

- P130S30** 30" Round Head With Numbers
- P130S30C** 30" Customized Round Head  
(One color logo, for extra colors call for quote)
- P131S30** 30" Flag Head With Numbers

Color-Fill Heads - Additional

**CUP BASE**

- P13030** 30" Round Head With Numbers
- P13030C** 30" Customized Round Head  
(One color logo, for extra colors call for quote)
- P13130** 30" Flag Head With Numbers

**PUTTING MARKER STICKS**

Handy built-in grip, and the head can be personalized with decals featuring your club logo. Numbered decals sold in sets only. Heads, rods and bases are sold separately.

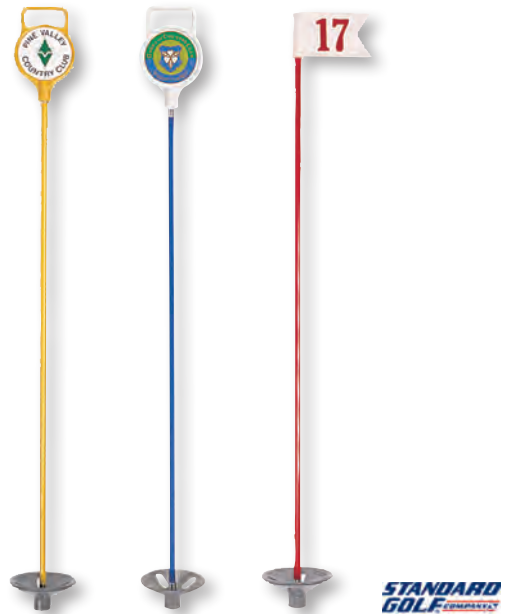

**CAST ALUMINUM HEAD**

- ST20532** White
- ST20533** Yellow
- ST20534** Red
- ST20535** Green
- ST20536** Blue
- ST20537** Black

**FIBERGLASS ROD**

- ST20182** Red
- ST20282** Black
- ST20382** White
- ST20482** Yellow
- ST20582** Blue
- ST20682** Green

**SOLID METAL BASE**

- ST20322** Base Only

SIGNAGE  
RANGE & PRACTICE  
TEE AREA  
FAIRWAY  
GREENS  
CLUBHOUSE, PRO SHOP, & TOURNAMENT  
RECYCLED PLASTICS  
SAFETY MAINTENANCE, & IRRIGATION

**PUTTING MARKER STICKS**

Extra strong 1/2" fiberglass rod complete with plastic "T" top for retaining flag. Choice of "cup base" for cup or "spike base" for use without cups. Flags not included. See next page for all putting flag options.



- P10030**
- P100S30**
- P100TK**

Rod With Cup Base - 30" Long  
Rod With Spike Base - 30" Long  
Replacement "T" Top

Stripes Not Included - Add \$2.00 Per Stripe



Cup Base



Spike Base



**DRIVING RANGE YARDAGE POLES**



Heavy duty 5-1/2" diameter, 8' long vertical markers, striped in barber pole style, or full length in colors of your choice. Plastic has guarantee against UV breakdown. Use an index sign at tee area to indicate yardages for each color. Available with flag tops. Eagle One now offers our popular Driving Range Yardage Poles with a highly reflective vinyl option for laser range finders.

- P075** Striped "Barber Pole"
- P075RT** Reflective Vinyl
- P075T** Flag Extension Package (flag not included)
- P095L** Large Flag



**SLEEVE**

In ground sleeve for yardage pole.

- P075S**



SIGNAGE

RANGE & PRACTICE

TEE AREA

FAIRWAY

GREENS

CLUBHOUSE, PRO SHOP, & TOURNAMENT

RECYCLED PLASTICS

SAFETY, MAINTENANCE, & IRRIGATION

SIGNAGE

RANGE & PRACTICE

TEE AREA

FAIRWAY

GREENS

CLUBHOUSE, PRO SHOP, & TOURNAMENT

RECYCLED PLASTICS

SAFETY MAINTENANCE, & IRRIGATION

**PUTTING FLAGS**

Putting Flags Size is 6 1/2" x 9 1/2"

**PLAIN**



**P500** Plain



**P510** Custom Screen Printed Logo\*



**P505** Custom Embroidered Logo  
Call For Quote

\* Screen Printed, 1 color. Cost for each additional color.

**PLAIN/NUMBERED**



**P555** Numbered Set 1-9



**P560** Numbered Set 10-18

Only the following color options are available for numbered flags:  
(Flag/Number)  
Yellow/Black, White/Black, White/Red, Red/White, Blue/White, Green/White

**BORDER WITH HANDLE**



**P530** Plain



**P540** Screen Printed\*



**P535** Embroidered Call For Quote

**CHECKERED FLAGS**

Checkered Putting Flags Size is 6" x 9 1/2"



Black Handle, Black Border  
(Black / White)



Green Handle, Green Border  
(Green / White)



Red Handle, Red Border  
(Red / White)



Black Handle, Black Border  
(Black / Yellow)

Wide selection of colors available.

**P545** Cut And Stitched Checks With Handle  
**P545X** Custom Color Checks



**GREENWOOD™ DIVIDER**

Pointed end with three spikes on under side to hold in position. Dimensions are: 2" x 4" x 4". Other colors may be available upon request.

**P051** Drive Range Divider - 2"X4"



**ANGLED DRIVING RANGE DIVIDER**

Made from 2" x 4" GreenWood™, this divider is 48" long and has angled edges. Three spikes on the underside help hold it into the turf.

**P056BRN**



**CLASSIC RANGE DIVIDER**

This is a new take on our moveable range divider. The new arch design will give your range a classic look. The new curved top really accentuates the look.

**P059A**



**REGAL DRIVING RANGE DIVIDER**

This great looking divider includes the Eagle One pattern on both sides. The GreenWood™ construction is extremely durable and will withstand the hard impact of a golf ball. Offered in two formats, three feet for hard mounting on concrete or with five spikes for placing into turf. The engraving can also be altered to allow for sponsor signs or messages to be set into the face if desired. Available in Green, White, Black and Driftwood.

- P053F** Divider With Feet
- P053FM** Divider With Feet With Message Board
- P053S** Divider With Spikes
- P053SM** Divider With Spikes With Message Board

SIGNAGE

RANGE &  
PRACTICE

TEE AREA

FAIRWAY

GREENS

CLUBHOUSE,  
PRO SHOP, &  
TOURNAMENT

RECYCLED  
PLASTICS

SAFETY,  
MAINTENANCE,  
& IRRIGATION

SIGNAGE  
 RANGE & PRACTICE  
 TEE AREA  
 FAIRWAY  
 GREENS  
 CLUBHOUSE, PRO SHOP, & TOURNAMENT  
 RECYCLED PLASTICS  
 SAFETY MAINTENANCE, & IRRIGATION

## SINGLE BAG STANDS

Give your range an upscale look with these classy GreenWood™ single bag stands. This unit folds up for easy storage.



**P094**  
Folding Bag Stand

**P0940S**  
Oversized Folding Bag Stand  
Oversized to accomodate cart bags.

## TWO CUP HOLDER BAG STAND

**P0792**



## GOLF BAG RACK - SINGLE

Durable powder coated steel tube. Lightweight. Standard color choices are Green and Black. Custom colors can be supplied.

**P090**  
Steel Golf Bag Stand



## SINGLE POSTED BAG STAND

This is ideal for use on turf ranges. Our solid GreenWood™ bag stand is very durable and low maintenance. Three metal spikes anchor base into turf while also being easy to remove and relocate. Color choices are Green, Driftwood, Black, White and Brown.

**P093**





**MODULAR BAG RACKS**

This design is made from high quality GreenWood™ is great for around the clubhouse or restaurant. Each unit holds up to five bags and is exceptional in applications such as a wall mounting, back to back or side to side. Dimension 67"L x 14"D x 32"H

**C048** 5 Bag Rack GreenWood™



**METAL BAG RACKS**

These sturdy bag racks are fabricated from steel and have a thick plastic overcoat. The three styles offer either bag racks both sides, bag rack one side only or bag rack one side and a bench on the other.

**C0606** Double Bag 6' Long  
**C0608** Double Bag 8' Long  
**C0616** Single Bag 6' Long

**C0618** Single Bag 8' Long  
**C0626** Bag / Bench 6' Long  
**C0628** Bag / Bench 8' Long



**MODULAR GREENWOOD™ BAG RACKS**

This design is made from 100% GreenWood™, will never split or rust and never needs painting. Each unit holds three bags and comes pre-drilled for connecting together - end to end or back to back. Color choices are: Black, White, Driftwood, Green and Brown. Dimension 36"L x 18"D x 31"H.

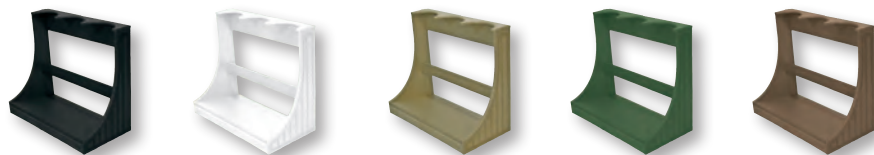

Also available is our two-tone bag racks that have the added options of a logo recessed into the side. Available in green and brown, or black and brown.

**C045NE** New England Engraving  
**C045NEBLKBRN** Two Tone New England

Please Specify Color When Ordering



SIGNAGE

RANGE &  
PRACTICE

TEE AREA

FAIRWAY

GREENS

CLUBHOUSE,  
PRO SHOP, &  
TOURNAMENT

RECYCLED  
PLASTICS

SAFETY,  
MAINTENANCE,  
& IRRIGATION

SIGNAGE  
RANGE & PRACTICE  
TEE AREA  
FAIRWAY  
GREENS  
CLUBHOUSE, PRO SHOP, & TOURNAMENT  
RECYCLED PLASTICS  
SAFETY MAINTENANCE, & IRRIGATION



## RANGE MATE® CLUB WASHER

- A new way to clean both woods, irons, and grips!
- Eliminates the splashing and splatter associated with expensive club washers!
- For use on driving range, par 3 holes and bag storage areas.
- Includes heavy duty powder coated wire stand.
- Available in Hunter Green, Desert Stone, and Gray Granite colors.
- Capacity: Holds 9 gallons of water.
- Wt.: 20lbs, Size: 15" diameter x 20" height.



- WGMB9106** Green Club Washer
- WGMB9802** Replacement Brush
- WGMB9800** Club Washer Brush Kit (2 Brushes, Frame & Screws)



Large Bi level brushes that gently scrub oversized woods, irons, and grips.

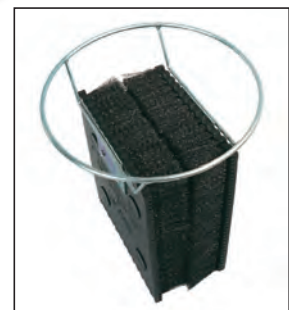

Replaceable brushes that can be reversed to extend their usefulness.

**CLUB WASHER**



Made from durable GreenWood™ that will not require any painting the washer includes a five gallon pail, hand brush, hooks for hanging tee towels and angled support for bracing club while scrubbing. The unit is a comfortable 33" high making it easy on your back. Color choices: Black, Brown, Cedar, Driftwood and Green. Towel not included.

**T212**  
**T212BRUSH**



**BALL / CLUB WASHER COMBO**



Suited for attachment to golf cart with bracket supplied. Made from high-impact plastic. Available in tan, black, green and white.

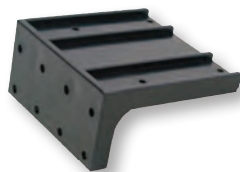

Ball / Club Washer Combination  
**T118**

Replacement Bracket For Ball  
Club Washer Combination  
**T118B**

Replacement Brush  
**T118BRUSH**

**CLUB CLEANER**

This plastic Club Cleaner will not rust or corrode and is virtually maintenance free. Just fill it with fresh water daily.

**RGLCCG01**  
Club Cleaner

**RGLCCG01RB**  
Replacement Brush



**ARCH DESIGN PULL TOP  
CLUB WASHER**

Made of maintenance free GreenWood™ this club washer will look great on any range. Top pulls off for brush replacement and water changing. Many colors and color combinations are available.

**P291A**  
Club Washer

**WGMB9802**  
Replacement Brush



SIGNAGE

RANGE &  
PRACTICE

TEE AREA

FAIRWAY

GREENS

CLUBHOUSE,  
PRO SHOP, &  
TOURNAMENT

RECYCLED  
PLASTICS

SAFETY,  
MAINTENANCE,  
& IRRIGATION



**DELUXE BALL WASHER**



Greeting golfers with a Par Aide Ball Washer at the tee has always made a positive statement. To make it a great statement, make sure it has fresh paint each year, and always has clean water, detergent and towels. Attention to detail.

Our most popular model. Drain plug located in front for easy cleaning and flushing. Patented internal overflow sends excess liquid down the inside of the pipe stand.

Capacity: 7 pt. (3.3 l)

- PAR203-01** Par Aide Red
- PAR203-02** Hunter Green
- PAR203-00** Black
- PAR203-99** Other colors, please specify

**MASTER BALL WASHER**

TO GENERATIONS OF GOLFERS, THERE'S NO OTHER BALL WASHER. Asked to draw a picture of a ball washer, a golfer would probably produce an image very similar to the photo on this page. What this proves is, the Par Aide Master Ball Washer is literally the picture of an accepted, expected and appreciated part of the golfing experience. Since 1954, it has earned its place by providing reliably excellent results for golfers and easy care for Superintendents and their crews.

The classic. Original design assures reliability: durable aluminum castings and just one moving part. Easy to maintain and update, eliminates leakage with tamper-resistant drain plug and gasket.

Unlimited color options. Capacity: 5 pt. (2.4 l)

- PAR205-01** Par Aide Red
- PAR205-02** Hunter Green
- PAR205-00** Black
- PAR205-99** Other colors, please specify



SIGNAGE  
RANGE & PRACTICE  
TEE AREA  
FAIRWAY  
GREENS  
CLUBHOUSE, PRO SHOP, & TOURNAMENT  
RECYCLED PLASTICS  
SAFETY MAINTENANCE, & IRRIGATION



**BALL WASHER CONSTRUCTION**

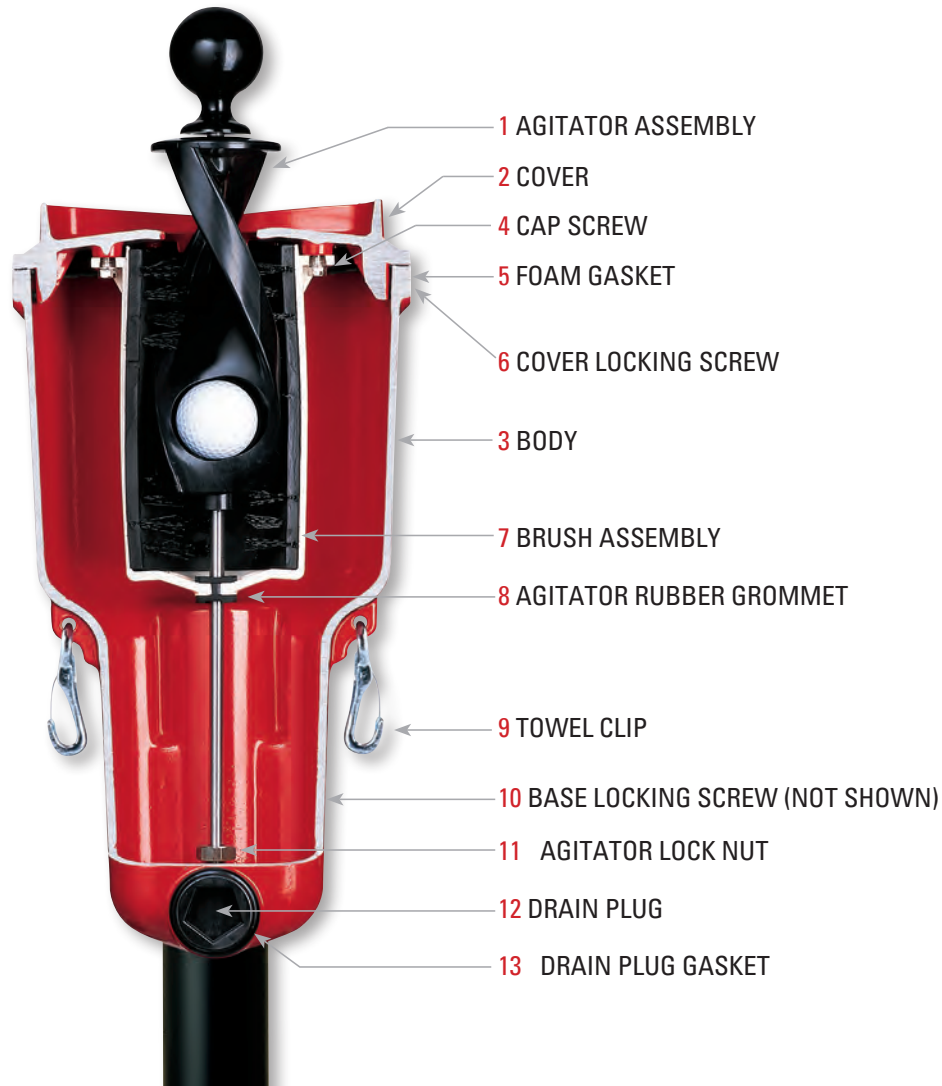

**1 AGITATOR ASSEMBLY**  
Includes hex nut, grommet and top knob  
**PAR200-30**

**2 BALL WASHER COVERS**  
Deluxe Cover  
**PAR2203-01** Par Aide Red  
**PAR2203-02** Hunter Green  
**PAR2203-00** Black  
**PAR2203-99** Other colors  
Master Cover  
**PAR2205-01** Par Aide Red  
**PAR2205-02** Hunter Green  
**PAR2205-00** Black  
**PAR2205-99** Other colors

**3 BALL WASHER BODIES**  
Deluxe Body  
**PAR1203-01** Par Aide Red  
**PAR1203-02** Hunter Green  
**PAR1203-00** Black  
**PAR1203-99** Other colors  
Master Body  
**PAR1205-01** Par Aide Red  
**PAR1205-02** Hunter Green  
**PAR1205-00** Black  
**PAR1205-99** Other colors  
**4 CAP SCREW**  
**PAR200-21-4** Package of 4  
**5 FOAM GASKET**  
**PAR203-25** Deluxe  
**PAR205-25** Master

**6 COVER LOCKING SCREW**  
**PAR203-70-6** Package of 6

**7 BRUSH ASSEMBLY**  
**PAR200-20**

**8 AGITATOR RUBBER GROMMET**  
**PAR200-11-4** Package of 4

**9 TOWEL CLIP**  
**PAR200-60-4** Package of 4

**10 BASE LOCKING SCREW**  
**PAR204-70-6** Package of 6

**11 AGITATOR LOCK NUT**  
**PAR200-80-4** Package of 4

**12 DRAIN PLUG WITH GASKET**  
**PAR203-40-4** Package of 4

**13 DRAIN PLUG GASKET**  
**PAR203-50-10** Package of 10

**14 DRAIN PLUG WRENCH**  
(Not Shown)  
**PAR203-10-4** Package of 4

**15 ALLEN WRENCH**  
(Not Shown)  
**PAR203-16-4** Package of 4

SIGNAGE

RANGE &  
PRACTICE

TEE AREA

FAIRWAY

GREENS

CLUBHOUSE,  
PRO SHOP, &  
TOURNAMENT

RECYCLED  
PLASTICS

SAFETY,  
MAINTENANCE,  
& IRRIGATION

These are a few of the ensembles created to make ordering easy for you. With all of these options, you can place your ensemble design where it's most needed. You may opt to put an ensemble with a Club Washer on the tee of a par 3 hole, for example, or one with a Trash Mate® double unit on the tee following the halfway house. Just start with the combination you like and pick a color. If you don't see the combination you are looking for, simply mix and match by choosing the individual items that best fit your situation.



SIGNAGE  
RANGE & PRACTICE  
TEE AREA  
FAIRWAY  
GREENS  
CLUBHOUSE, PRO SHOP, & TOURNAMENT  
RECYCLED PLASTICS  
SAFETY MAINTENANCE, & IRRIGATION

## MASTER BALL WASHER ENSEMBLES



### MASTER ENSEMBLE

- PAR50-01** Par Aide Red
- PAR50-02** Hunter Green
- PAR50-00** Black
- PAR50-99** Other color, please specify

- PAR552-11** Add a spike brush
- PAR55-01** Par Aide Red with spike brush
- PAR55-02** Hunter Green with spike brush
- PAR55-00** Black with spike brush
- PAR55-99** Other color with spike brush



### MASTER ENSEMBLE WITH TRASH MATE SINGLE UNIT\*

- PAR51-01** Par Aide Red
- PAR51-02** Hunter Green
- PAR51-00** Black
- PAR51-99** Other color, please specify

- PAR552-11** Add a spike brush
- PAR53-01** Par Aide Red with spike brush
- PAR53-02** Hunter Green with spike brush
- PAR53-00** Black with spike brush
- PAR53-99** Other color with spike brush
- \*Trash opening lid included



### MASTER ENSEMBLE WITH TRASH MATE DOUBLE UNIT\*

- PAR52-01** Par Aide Red
- PAR52-02** Hunter Green
- PAR52-00** Black
- PAR52-99** Other color, please specify

- PAR552-11** Add a spike brush
- PAR54-01** Par Aide Red with spike brush
- PAR54-02** Hunter Green with spike brush
- PAR54-00** Black with spike brush
- PAR54-99** Other color with spike brush
- \*One trash and one "Cans Only" lid included

## DELUXE BALL WASHER ENSEMBLES



### DELUXE ENSEMBLE

- PAR30-01** Par Aide Red
- PAR30-02** Hunter Green
- PAR30-00** Black
- PAR30-99** Other color, please specify

- PAR552-11** Add a spike brush
- PAR35-01** Par Aide Red with spike brush
- PAR35-02** Hunter Green with spike brush
- PAR35-00** Black with spike brush
- PAR35-99** Other color with spike brush



### DELUXE ENSEMBLE WITH TRASH MATE SINGLE UNIT\*

- PAR31-01** Par Aide Red
- PAR31-02** Hunter Green
- PAR31-00** Black
- PAR31-99** Other color, please specify

- PAR552-11** Add a spike brush
- PAR33-01** Par Aide Red with spike brush
- PAR33-02** Hunter Green with spike brush
- PAR33-00** Black with spike brush
- PAR33-99** Other color with spike brush
- \*Trash opening lid included



### DELUXE ENSEMBLE WITH TRASH MATE DOUBLE UNIT, SPIKE BRUSH AND CLUB WASHER\*

- PAR34-01** Par Aide Red
- PAR34-02** Hunter Green
- PAR34-00** Black
- PAR34-99** Other color, please specify
- \*One trash and one "Cans Only" lid included

STOCK COLORS					OPTIONAL COLORS No additional charge				CUSTOM
PAR AIDE RED	HUNTER GREEN	BLACK	YELLOW	WHITE	IMPERIAL BLUE	PAR AIDE BLUE	INDUSTRY BROWN	CAMEL BEIGE	ANY COLOR



**PREMIER 7 PINT  
BALL WASHER**



This washer consist of a powder coated, cast aluminum case and top with easy to use plunger style agitator. It includes an internal overflow and large drain for easy maintenance. Hardware is stainless steel and plunger knob is easily replaceable if damaged. Mounting is over a 23/8" outside diameter post. Mounting is on a choice of the "Tradition" console comprising a cast aluminum hexagon base and 34" long steel tube, tripod console or 48" long permanent post.

- ST01425** Red
- ST01450** Green
- ST01470** Black



**MEDALIST 5 PINT  
BALL WASHER**



This ball washers consist of a powder coated, cast aluminum case and top with easy to use plunger style agitator. Hardware is stainless steel and plunger knob is easily replaceable if damaged. Drain is in base of support throat that fits inside a standard 23/8" OD pipe. Colors include red, green, desert tan and black. Mounting is on a choice of the "Tradition" console comprising a cast aluminum hexagon base and 34" long steel tube, tripod console or 48" long permanent post.

- ST01525** Red
- ST01550** Green
- ST01570** Black



**CLASSIC BALL WASHER**



Made form plastic the classic ball washer includes no-splash crank operation and overflow tube to prevent leaks and soap build up. Colors include yellow, red, brown, green, black, blue, and white. Free club logo is supplied with each order of nine or more.

- ST01300** Classic Ball Washer - Yellow
- ST01325** Classic Ball Washer - Red
- ST01340** Classic Ball Washer - Brown
- ST01350** Classic Ball Washer - Green
- ST01370** Classic Ball Washer - Black
- ST01375** Classic Ball Washer - Blue
- ST01395** Classic Ball Washer - White

**CONSOLES, POSTS & BASES**

**ST36230**  
Tradition Console



**ST36200**  
Tripod Console



**ST36248**  
48" Black Permanent  
Mounting Post



SIGNAGE  
RANGE & PRACTICE  
TEE AREA  
FAIRWAY  
GREENS  
CLUBHOUSE, PRO SHOP, & TOURNAMENT  
RECYCLED PLASTICS  
SAFETY MAINTENANCE, & IRRIGATION



**BALL WASHER ATTACHMENTS**

Square Spike Brush  
**C008**

Single Brush And Bracket  
**C010S**

Double Brush And Bracket  
**C010D**



**SUPPORT BRACKET**

This handy arm clamps onto your ballwasher support pipe and allows our "Tuff Guy" trash bin to be supported by its steel spike. This system allows easy removal for dumping of trash.



**T179**  
Tuff Guy Support Bracket  
Pipe Mount



**T192**  
Tuff Guy Support Bracket  
Post Mount

**EAGLE ONE BALL WASHER SOLUTION AND TABLETS**

**T099** Ball Washer Washing Solution  
1 Gallon

**PAR4102** Ball Washer Tablets, 450



**SPARKLEEN DETERGENTS**



Concentrated formula, contains special cleaners and brighteners, won't go rancid in hot weather, pint bottle exactly measure the 1/2 oz requirement.

**ST03100** Eco Max Detergent Tablets, 500 Per Jar

**ST03300** Case Of Four, One Gallon Containers

**ST03301** Case Of 12, One Pint Containers





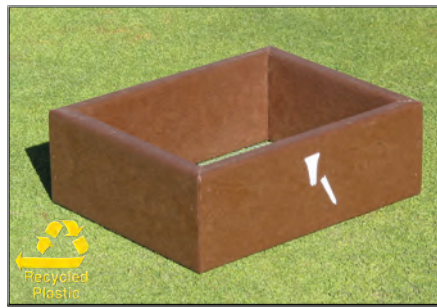

**ECONOMY GREENWOOD™  
BROKEN TEE CADDIE**

For the budget conscious, our new 2" high economy Greenwood™ broken tee caddie works great on any tee box. Many colors available.

Economy Greenwood™ Broken Tee Caddie  
**T037**

**GREENWOOD™ BROKEN TEE CADDIE**

GreenWood™ caddie 4" high with open steel mesh base. Available in Driftwood, Green, Black and Brown.

**T036** Greenwood™ No Pattern  
**T036DP** Greenwood™ With Engraving

**BELL SHAPED BROKEN TEE CADDIE**

Consists of powder coated finish over a spun steel construction. Height is 6" and a 5" spike holds caddie in the ground. Colors include; Red, White, Blue, Yellow, Green and Black.



**ST19000** Black, White Decal  
**ST19015** Yellow, Black Decal  
**ST19025** Red, White Decal  
**ST19050** Green, White Decal  
**ST19075** Blue, White Decal  
**ST19095** White, Black Decal

**STANDARD  
GOLF COMPANY**



**SCORE CARD CADDIE**

Made from either 100% GreenWood™ and mounted on a 4" x 4" x 5' post, or separate if required. Divider separates pencils from score cards.

Inside dimensions: 14½" long, 6" high, 9½" wide. Color choices are: Black, Brown, Driftwood and Green.

Score Card Caddie On 5' Post  
**T060**

Score Card Caddie Only  
No Post  
**T061**

Score Card Caddie On 4x4 Post And  
Pedestal Base  
**T061RPB**

**CLASSIC SCORE  
CARD CADDIE**



Just another one of the innovative new designs from Eagle One. Made of 100% recycled plastic.

**T059**



SIGNAGE

RANGE &  
PRACTICE

TEE AREA

FAIRWAY

GREENS

CLUBHOUSE,  
PRO SHOP, &  
TOURNAMENT

RECYCLED  
PLASTICS

SAFETY,  
MAINTENANCE,  
& IRRIGATION



Cambridge towels are all made of the highest quality fabrication and Eagle One is proud to have them exclusively for the golf industry. We can also customize them with your logo or design (minimum of 18). Grommet placed at your request.



**CLUBHOUSE TOWELS**

Available in White. Different colors and styles are available by special order. 100% American cotton.

- GSH062500** Bathsheet, 13.5lbs/DZ, 30" x 59"
- GSH062520** Hand Towel, 3lbs/DZ, 12" x 27.5"
- GSH062510** Face Cloth, 1.2lbs/DZ, 13" x 13"

**GSH062530** Pre-Pack (24 of each towel)  
**QUANTITY DISCOUNT FROM BUYING INDIVIDUALLY!**  
**SAVE OVER 10%!**

Color Options Available:

Emerald Green



Indigo Blue



Black



**CART TOWELS**

These are made of the highest quality terry cloth for greater moisture absorption. Available in Black, Emerald Green, and Indigo Blue. Size: 2lbs/DZ, 15" x 24."

**GSH062560** case of 150

**BACK SHOP TOWELS**

At only \$1 per towel, these make a great and high quality economical towel for back shops, mechanics, and facility maintenance crews. Pre-packed from the mill with various sizes and colors, and no two boxes are alike. Every box will be different and will include many colors not shown. Customization not available for Back Shop Towels. Size: 16" wide x various lengths. 100% American cotton.

**GSH062550** case of 144

SIGNAGE  
 RANGE & PRACTICE  
 TEE AREA  
 FAIRWAY  
 GREENS  
 CLUBHOUSE, PRO SHOP, & TOURNAMENT  
 RECYCLED PLASTICS  
 SAFETY MAINTENANCE, & IRRIGATION

**WASHABLE TEE TOWELS**

Washable tee towel. Super absorbent, tough and durable. 7" x 21". 200 towels per case.

**T253** per case



**DISPOSABLE TEE TOWELS**

CHIX DISPOSABLE  
Soft And Very Absorbent, Nylon Reinforced Throughout.  
Green White. 200 per case.

**ST04965**



**BALLWASHER / TRI-FOLD TOWELS**

These are velour on one side for soft touch and to help embroidered logos stand out, while on the back side they are terry cloth for scrubbing power and moisture absorption. Can be sold plain or include a dog ear and grommet in the corner with a clip. We can also customize them with your logo or design (minimum of 18). Grommet placed at your request. 100% American cotton and washable.

Washable, cotton velour/terry cloth, hemmed tee towel.  
16" x 24," 2.6 lbs/DZ. Available in Emerald Green, Indigo Blue, and Black.

- T1829P** Plain Towel
- T1829T** Plain Towel Tri-Fold & Grommet
- T1829G** Plain Towel Corner Grommet
- T1829E** Embroidered Logo
- T1829S** Screened Logo



- SIGNAGE
- RANGE & PRACTICE
- TEE AREA
- FAIRWAY
- GREENS
- CLUBHOUSE, PRO SHOP, & TOURNAMENT
- RECYCLED PLASTICS
- SAFETY, MAINTENANCE, & IRRIGATION

**DOME TEE MARKERS**

These 4" round markers are made from very durable polyethylene and are very inexpensive. A 3" long steel spike holds them in position.

Available: red, white, blue, black and yellow.

**T024**



SIGNAGE

RANGE & PRACTICE

TEE AREA

FAIRWAY

GREENS

CLUBHOUSE, PRO SHOP, & TOURNAMENT

RECYCLED PLASTICS

SAFETY MAINTENANCE, & IRRIGATION

**"LOLLIPOP" TEE MARKERS**

This "Lollipop" design tee marker is made from solid two tone sign board. Logo is recessed below surface and the one piece design reduces the chance of breakage. Primary colors are; red, white, blue, yellow and green, for other choices see selection at the bottom of the page. Single or double sided.

- T040R1** Logo One Side
- T040R2** Logo Two Sides
- Minimum order of 18 at this price.

**Custom Lollipop Tee Marker** Custom shapes are available.  
**T041** Call For Quote



**SHIELD TEE MARKERS**

Like the lollipop tee marker the shield tee marker is also made from two-tone sign board and is supported with a steel spike. Logo can be either engraved in or created on vinyl and recessed down. Single or double sided.

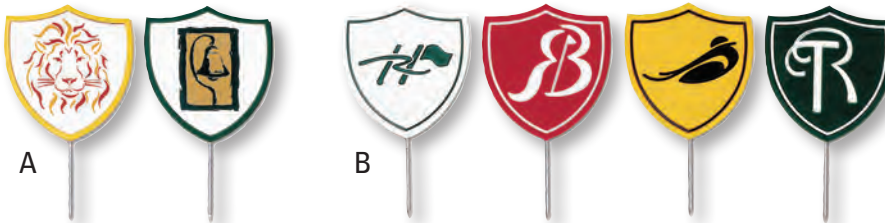

- A. **T042R1** Recessed Logo One Side 0
- T042R2** Recessed Logo Two Sides

- B. **T042E1** Engraved Logo One Side
- T042E2** Engraved Logo Two Side
- Minimum order of 18 at this price.

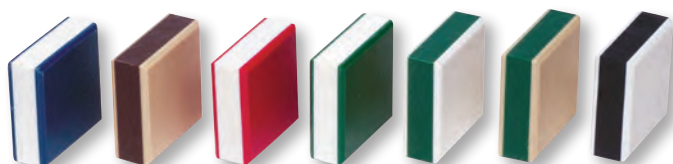

**PLASTIC SIGN BOARD COLOR CHOICES**

**BALL TEE MARKERS**

"With Neck"



- T0023** 3" With Neck
- T0024** 4" With Neck
- T0024C** 4" With Neck - Custom Logo

"No Neck"



- T002NN3** 3" No Neck
- T002NN4** 4" No Neck
- T002NN4C** 4" No Neck - Custom Logo



Angled Ball Marker  
**T002A**

Durability and good looks rolled into one. Made from a specially formulated resin these solid tee markers are almost indestructible. They are so tough they bounce on smooth concrete like a ball and do not leave a scratch. Unique bottom stem keeps markers at the same height while minimizing grass burnout spots. Comes mounted on a stainless steel spike. Colors are U.V. stabilized offering years of service and because color is all the way through they will never need painting. Available in 2 sizes: 3" and 4". The 4" can be customized with logo's using laser engraving, which is then smoothed over. Available colors: red, white, blue, yellow, green, black and gray. If customized, this product may take extra time to deliver.



**T002KIT** Refurbish Kit

**DIMPLE TEE MARKERS**

These popular 5" dimpled Tee Markers are hollow and made from rugged plastic. Available in two choices: Plain and Customized with club Logo. Extensive color choices: Red, White, Blue, Yellow, Black, Silver, Gold, Orange & Green. Logo is additional charge.

- ST05250 - ST05259** Plain
- ST05270 - ST05279** Customized



**STANDARD  
GOLF** COMPACT

**FusionCast™**  
ENGINEERED METAL CASTING TECHNOLOGY

**TEE BLOCK MARKERS**

**FUSTEEMARKER** Call For Quote



**CAST BRONZE TEE MARKERS**

Solid bronze tee marker with 5" diameter face displaying your course logo.

Shaft is angled to project face slightly up. Custom colors available.



**T033**  
Call For Quote

**T031**  
Call For Quote



4" x 6"



6" x 4"



4" x 6"



6" x 4"



5"



5" x 5"



4" x 6"

SIGNAGE  
RANGE & PRACTICE  
TEE AREA  
FAIRWAY  
GREENS  
CLUBHOUSE, PRO SHOP, & TOURNAMENT  
RECYCLED PLASTICS  
SAFETY MAINTENANCE, & IRRIGATION

**CUSTOM MOLDED TEE MARKERS**

**T006** Custom Molded Tee Marker Call For Quote



**WEDGE & CUSTOMIZED WEDGE TEE MARKERS**



This is a great low profile marker made from solid GreenWood™. Wedge shape protects patrons from ricocheting balls. Available colors are Red, Blue, Yellow, White and Black.

**T011**



This is a great low profile marker made from solid GreenWood™. Logo is applied to underside of clear lexan sheet for protection from the environment. Wedge shape protects patrons from ricocheting balls. Available colors are Red, Blue, Yellow, White and Black.

**T011C** (minimum of 18)

**ARROWHEAD TEE MARKERS**



Solid GreenWood™ with one spike. Available in: Red, White, Blue, Yellow and Black.

**T016**

SIGNAGE

RANGE &  
PRACTICE

TEE AREA

FAIRWAY

GREENS

CLUBHOUSE,  
PRO SHOP, &  
TOURNAMENT

RECYCLED  
PLASTICS

SAFETY,  
MAINTENANCE,  
& IRRIGATION

SIGNAGE  
RANGE & PRACTICE  
TEE AREA  
FAIRWAY  
GREENS  
CLUBHOUSE, PRO SHOP, & TOURNAMENT  
RECYCLED PLASTICS  
SAFETY MAINTENANCE, & IRRIGATION

**TOURNAMENT TEE MARKERS**



- T007CP** Tournament Tee Marker - Plain Cube
- T007P** Tournament Tee Marker - Rectangular
- T007C** Custom Tee Marker - Cube
- T007R** Custom Tee Marker - Rectangle

**CUBE TEE MARKERS**



Year in and year out this is our most popular tee marker for the budget-minded superintendent. Super durable and never needing paint, they are made from solid GreenWood™. They float in water and color is throughout.

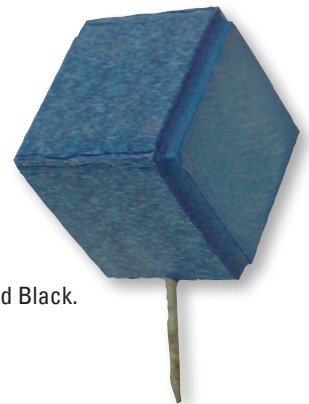

Available colors: Red, Blue, Yellow, White and Black.

**T015**

**CAPITOL TEE MARKERS**



Solid GreenWood™ ensures extreme durability. This marker floats and stock colors are red, white, blue, yellow. Black, green and other colors available upon request.

**T013**



**R2-TEE2 COLOR FILLED MARKERS**

Real wood looks with almost no maintenance. Routed and color filled bands around each marker indicate each tee position. Ideal when unique colors are needed since virtually all colors can be used.

**T018CFBRN**







With Logo Call For Quote



**LOG TEE MARKERS**

These attractive three dimensional tee markers are molded from extremely strong and durable resins. Base colors are dyed throughout and can be color matched to any color. There are already many designs available as a standard but for minimal setup cost any custom shape can be produced from your supplied sample or a plug can be created for you. Can be customized to your needs.

**T001**

Log Tee Markers

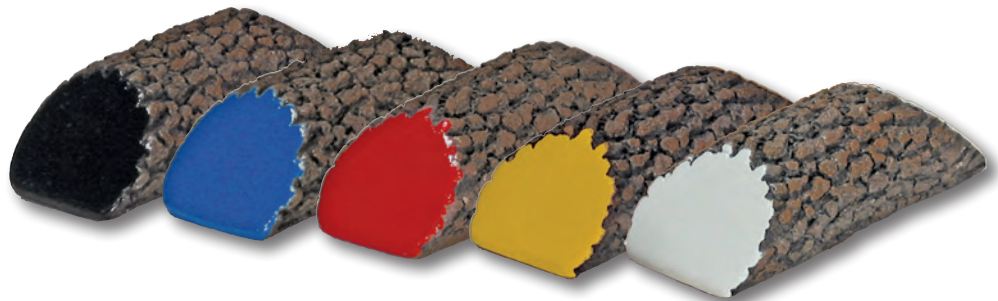

**SLIM LIMB TEE MARKERS**

**T009**

Slim Limb Tee Marker



**9" X 12" DIG IN MARKERS**



Fabricated from 2" thick GreenWood™, these markers are durable and very visible. Yardages are recessed behind a clear lexan cover and your course logo can be included for added decoration and style. Markers are 12" long by 9" wide and can be supplied in red, white, blue, brown, black and driftwood. Two steel spikes underneath help hold it down.

**F134C**

**SEMI-CIRCLE TEE MARKERS**



These tee markers are only an example of the many tee markers Eagle One can design. Made of maintenance free recycled plastic these marker use a super durable color fill system that doesn't fade. Available in a wide variety of colors. Call to discuss.

**T038**

SIGNAGE

RANGE & PRACTICE

TEE AREA

FAIRWAY

GREENS

CLUBHOUSE, PRO SHOP, & TOURNAMENT

RECYCLED PLASTICS

SAFETY, MAINTENANCE, & IRRIGATION

## TAPERED LITTER CADDIES

Constructed of stainless steel mesh body, welded carbon steel rims and bottom, and powder - coated finish. Steel turf-saver spike keeps base off turf and allows easy relocation during mowing or use steel cone base for hard surfaces. Two sizes; 9 gallon and 30 Gallon and colors include white, red, blue, yellow, green and black.

Please call for a full list of available colors.



- ST13150** 9 Gallon With Spike Base - Red
- ST13700** 9 Gallon With Spike Base - Green
- ST13195** 9 Gallon With Spike Base - Black
- ST13152** 9 Gallon With Cone Base - Red
- ST13800** 9 Gallon With Cone Base - Green
- ST13197** 9 Gallon With Cone Base - Black

- ST13050** 30 Gallon With Spike Base - Red
- ST13075** 30 Gallon With Spike Base - Green
- ST13095** 30 Gallon With Spike Base - Black
- ST13053** 30 Gallon With Cone Base - Red
- ST13078** 30 Gallon With Cone Base - Green
- ST13098** 30 Gallon With Cone Base - Black



## LITTER CADDIE LINER



Flexible and very durable, this black polypropylene liner folds and snaps open inside to hide litter. Easily removable for cleaning. They fit the 9 gallon and 30 gallon Litter Caddies.

- ST13850** 9 Gallon Liner (Sold in Box of Three)
- ST13870** 20 Gallon Liner (Sold in Box of Two)
- ST13860** 30 Gallon Liner (Sold in Box of Two)

## TRASH MATE®

- Polyethylene: impervious to rusting and denting.
- Maximum UV protection added to prevent brittleness and fading.
- Capacity: 9 gal. (34.1 liter) also accepts trash bag liners.
- Windproof, snap-on lids available in three styles, all Black: solid (no opening) to resist pests, trash opening and "Cans Only" opening.
- Convenient attachment to ball washer pipe reduces number of objects to be moved before moving.
- Flexible design allows you to add a second receptacle for recycling.
- Stackable/nesting design saves storage space.
- Mounting hoops are pre-treated for added protection and then powder coated.



Comes with one trash opening lid and all necessary mounting hardware.

- PAR3005-00** Black
- PAR3005-01** Red
- PAR3005-02** Hunter Green

Extra mounting hardware available sold separately. Please call.



**PAR3030**  
Low Stand



**PAR3031**  
In-Ground Stand



Cans Only



Trash



Solid

SIGNAGE

RANGE & PRACTICE

TEE AREA

FAIRWAY

GREENS

CLUBHOUSE, PRO SHOP, & TOURNAMENT

RECYCLED PLASTICS

SAFETY MAINTENANCE, & IRRIGATION



THE  
**TUFF GUY™**  
LITTER CADDIE

**TUFF GUY™ LITTER CADDIE**

Eliminate unsightly bent and rusty wire baskets with the Tuff Guy™ Litter Caddie. The benefits of these polyethylene plastic litter caddies include:

- Inexpensive
- High-impact resistant
- Conceals unsightly trash
- Low-maintenance—wipes clean
- Handsome addition to any course
- Returns to original shape if buckled
- Personalize with your course logo
- Spikes into turf/consoles or attaches to cone base
- Colorfast

- T162** 9 Gallon Caddie With Spike Base
- A. **T160BASE** 9 Gallon Cone Base
- T163** 30 Gallon Caddie With Spike Base
- B. **T175BASE** 30 Gallon Cone Base
- T162LID** Lid For T162 Caddie
- T308** 9 Gallon With Lid And Lanyard
- T162C** Custom Decal Or Logo Only

Available in the following colors:  
Green, Black, Grey Granite  
Custom colors available upon special request.

**TUFF GUY™ ASHTRAY**

This handy addition to our popular "TUFF GUY" trash bin helps out your "smokers" and helps keep the course clean and safer from fire. Made from GreenWood™ the donut shaped insert has an area for a ring of sand for extinguishing cigarettes and then a center hole for disposal. Donut can easily be removed for dumping. Colors include Green, Black, White, Driftwood.

- T162ASH** Ashtray Top Only
- T162** Tuff Guy Trash Bin



**METAL TRASH RECEPTACLE**

9 gallon trash capacity, steel construction, powder coat finish, and spike bottom allows you to locate it anywhere.

- MIL625100** Black
- MIL625102** Green
- MIL625109** Special Color

SIGNAGE

RANGE &  
PRACTICE

TEE AREA

FAIRWAY

GREENS

CLUBHOUSE,  
PRO SHOP, &  
TOURNAMENT

RECYCLED  
PLASTICS

SAFETY,  
MAINTENANCE,  
& IRRIGATION

SIGNAGE  
RANGE & PRACTICE  
TEE AREA  
FAIRWAY  
GREENS  
CLUBHOUSE, PRO SHOP, & TOURNAMENT  
RECYCLED PLASTICS  
SAFETY MAINTENANCE, & IRRIGATION

**5.25 GALLON DIVOT MIX CONTAINER**



The inside dimensions are 16" x 8 1/2" x 9".  
The hinged lid keeps seed dry. Available in Green, Brown, Driftwood and Black.

**T306NE** New England

Our newest engraving design with color fill will look fantastic on any golf course or driving range. Many colors and color combinations are available; please call our customer service to discuss.

**T306AF** Color Fill



**DIVOT MIX CONTAINER ON WHEELS**

We've added wheels and a removable handle to our T306 Divot Container to make it more mobile. Simply place the handle in the coupling on the back to relocate the unit and then take the handle to the next container. We offer a retro fit kit for existing T306 containers. Color choices are: Black, Brown, Driftwood and Green.

**T306WHNE** New England With Wheels  
**T306H** Replacement Handle (sold separately)

**GREENWOOD™ DIVOT MIX CONTAINER**

These sturdy boxes are made from solid GreenWood™. The board joints are tongue and groove containing divot mix internally. Sturdy legs support the box off the ground to protect turf. Green only. Two sizes to choose from: Small 38 x 26" x 30", Large 42" x 31" x 38"

Mini GreenWood™ Divot Mix Box. Well maybe not exactly mini but smaller and more price efficient than our traditional T305's. Great for busy Par 3 tee boxes or cart bottle refill stations. Mini 30" x 21" x 26".



A. **T305L** Large  
B. **T305S** Small



C. **T305M** Mini



**JUNIOR SEED AND SOIL BUTLER**

Low profile design from polyethylene construction. Comes complete with a hinged lid, stand and scoop. Includes the decals: "Fill & Smooth Divots" and "Scorecards & Pencils" (2 of each). Capacity: 4 gallons. Weight: 7lbs.

**ST18930** Green  
**ST18940** Black

**5 OR 10 GALLON ALL GREENWOOD™  
DIVOT MIX CONTAINER**

Weather proof 100% Greenwood™ constructed 5 and 10 gallon Divot Mix Container. Features Greenwood™ frame, three pointed slats for anchoring and a heavy duty Greenwood™ lid. All units include easily removable plastic bucket and scoop. Color choices are Black, Green, Brown and Driftwood.



**T330** 5 gallon  
**T323** 10 gallon

**5 GALLON DIVOT MIX CONTAINER**

Weather proof 100% Greenwood™ slats on a powder coated steel frame. Plastic bucket removes easily for dumping. Comes with a scoop and lanyard tie between the lid and bucket. Spiked legs support unit off the grass. Can also be used for trash. Color choices are Black, Green, Brown and Driftwood.

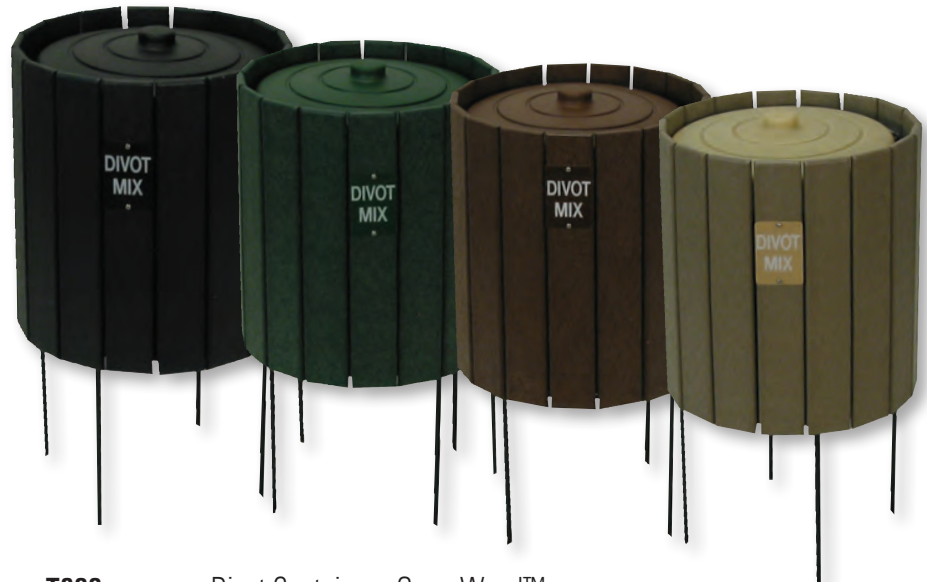

**T300** Divot Container - Greenwood™  
**T300SCOOP** Replacement Scoop For Divot Container  
**T300BIN** Replacement Bin  
**T300LID** Replacement Lid With Lanyard

SIGNAGE

RANGE &  
PRACTICE

TEE AREA

FAIRWAY

GREENS

CLUBHOUSE,  
PRO SHOP, &  
TOURNAMENT

RECYCLED  
PLASTICS

SAFETY,  
MAINTENANCE,  
& IRRIGATION

SIGNAGE  
RANGE & PRACTICE  
TEE AREA  
FAIRWAY  
GREENS  
CLUBHOUSE, PRO SHOP, & TOURNAMENT  
RECYCLED PLASTICS  
SAFETY MAINTENANCE, & IRRIGATION

## SEED MIX TUBES

This seed mix tube is an ideal item for golfers who love to walk the course. The translucent plastic tube containing seed mix for repairing divots is kept convenient by clipping to the golfer's golf bag. Size is not so large to be too heavy.



15oz Seed Mix Tube  
**PS100**

Seed Mix Tube Cap  
**PS100CAP**

Seed Mix Tube Clip  
**PS100CLIP**

## DIVOT MIX BOTTLES & BOTTLE CONTAINERS

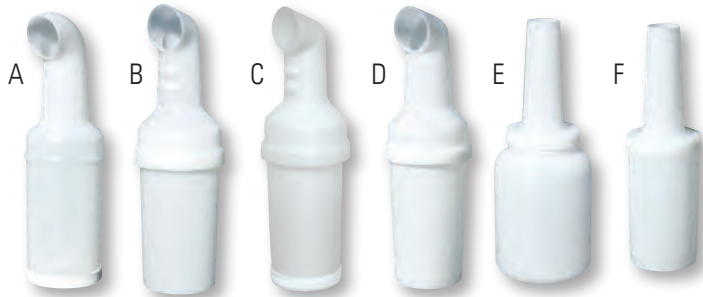

- A - **T312CBF** Bottom-Fill, Curved Neck, 45oz.
- B - **T312CGN** Top-Fill, Curved Neck With Grip, 45oz.
- C - **T312CGNBF** Bottom-Fill, Curved Neck With Grip, 45oz. Now With Rattle Proof Feature
- D - **T312C** Top-Fill, Curved Neck, 35oz.
- E - **T312L** Top-Fill, Straight Neck, 64oz.
- F - **T312S** Top-Fill, Straight Neck, 32oz.

## DIVOT TUBE STORAGE BOX FOR PS100 SEED MIX TUBES



**T317A** Large Seed Tube Box

**T317** Seed Tube Box

This box makes it very convenient for your walkers to replenish their seed tubes. It is made from low maintenance GreenWood™ and holds 40 tubes.  
 A. Size is 48" Long x 22 3/8" Wide x 17.5" Deep x 36" High.  
 B. Size is 24" Long x 17" Wide x 17.5" Deep x 36" High.  
 Standard color is Green, though Black, Brown and Driftwood are available upon special request.



### DIVOT BOTTLE STORAGE BOX

**T310NE**  
54 Bottles

**T311NE**  
24 Bottles

These boxes can be used in a variety of locations to organize your divot mix bottles. Made of 100% GreenWood™ the larger box holds 54 bottles (1 Quart) and is 34" L x 25" W x 17 1/2" D x 36" H. The smaller box holds 24 bottles (1 quart) and is 24" L x 17" W x 17 1/2" D x 36" H.

### SINGLE DIVOT BOTTLE HOLDER

No rust to worry about with this item. Made from GreenWood™ this sand and seed bottle holder holds one 2 qt. bottle. It comes with 3/8" spike for anchoring into tee area turf. Bottle not included.

**T309NE**



### FAIRWAY DIVOT BOTTLE HOLDER

Position this long handle bottle holder where divots fail to get filled in your fairways. The long handle allows a fairway mower operator to easily pick up and mow over.

**F100**  
Fairway Divot Bottle Holder

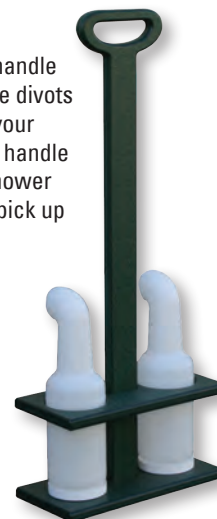

**SEED AND SOIL  
BOTTLE WITH CADDIE**



This steel caddy with 5" spike supports a 0.6 gallon (78 oz.) plastic bottle. Bottle has curved neck for weather protection and screw off bottom for refilling.

Seed And Soil Caddy - Black  
**ST18800**

Seed And Soil Caddy - Green  
**ST18900**

Replacement 78 oz Bottle  
**ST18802**



**WIRE DIVOT BOTTLE HOLDER**



Comes in two sizes: one or two quart bottles. Holds curved or straight necked bottles. They simply spike down into the turf at the tee box to hold the plastic divot bottles. Bottles not included.

**T3191** 1 Quart, 32 oz.  
**T3192** 2 Quart, 64 oz.



**ANGLED DIVOT MIX  
BOTTLE HOLDER**

Super sturdy this unit holds 40 1qt. divot bottles. Made of 100% GreenWood™ recycled plastic this holder has an empty bottle tray on bottom. The T327 is perfect for turn or first tee and comes in a variety of colors.



**T327**

**FREE STANDING DIVOT  
MIX BOTTLE HOLDERS**

This super sharp looking free standing bottle holder holds 24 1qt bottles, (bottles not included) and is made from 100% GreenWood™ recycled plastic. Open bottom area accepts empty bottles. Perfect for turn or first tee.



**T326**

**BOTTLE STORAGE**

GreenWood™  
**T315** 12 Bottles, 1 Qt  
**T316** 12 Bottles, 2 Qt  
**T315-24** 24 Bottles, 1 Qt  
**T316-24** 24 Bottles, 2 Qt  
Bottles not included.



Bottles sold separately. Please see page 145.

**DIVOT MIX BOTTLE RACK**

These double racks make it easier for loading your divot bottles in an efficient way while still having a clean, professional look. Portable recycled plastic crates hold 30 – 40 oz. bottles each with their own individual placement holes. Available in a variety of colors.

**T329**



SIGNAGE

RANGE &  
PRACTICE

TEE AREA

FAIRWAY

GREENS

CLUBHOUSE,  
PRO SHOP, &  
TOURNAMENT

RECYCLED  
PLASTICS

SAFETY,  
MAINTENANCE,  
& IRRIGATION



These rakes are made of impact resistant, high density polyethylene. The extremely durable head is slightly tapered to reduce unsightly furrows left by rakes with straight ends. Available in two widths, 17" and 25".

**ACCUFORM ACE II RAKE**

SIGNAGE  
RANGE & PRACTICE  
TEE AREA  
FAIRWAY  
GREENS  
CLUBHOUSE, PRO SHOP, & TOURNAMENT  
RECYCLED PLASTICS  
SAFETY MAINTENANCE, & IRRIGATION



17" Accuform Ace II Rake Head



25" Accuform Ace II Rake Head



Accuform Grip



Fiberglass Honeycomb Handle



Fiberglass Hollow Handle

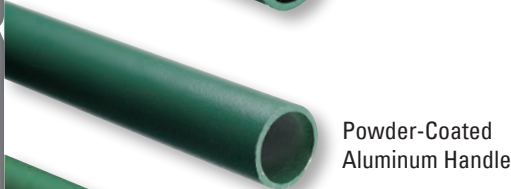

Powder-Coated Aluminum Handle

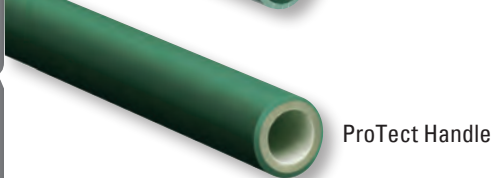

ProTect Handle

Complete Individual AccuForm Ace II Rake

- PAR990-1** 17" Head w / Handle Accuform 54" Honeycomb Green
- PAR990-3** 17" Head w / Handle Accuform 54" Hollow Green
- PAR990-10** 17" Head w / Handle Accuform 54" Aluminum Brown
- PAR990-5** 17" Head w / Handle Accuform 54" Aluminum Green
- PAR990-8** 17" Head w / Handle Accuform 54" Pro Tect Coating Green
- PAR990-4** 17" Head w / Accuform 72" Hollow Green
- PAR990-9** 17" Head w / Accuform 72" Pro Tect Coating Green
- PAR995-1** 25" Head w / Handle Accuform 54" Honeycomb Green
- PAR995-3** 25" Head w / Handle Accuform 54" Hollow Green
- PAR995-10** 25" Head w / Handle Accuform 54" Aluminum Brown
- PAR995-5** 25" Head w / Handle Accuform 54" Aluminum Green
- PAR995-8** 25" Head w / Handle Accuform 54" Pro Tect Coating Green
- PAR995-4** 25" Head w / Handle Accuform 72" Hollow Green
- PAR995-9** 25" Head w / Handle Accuform 72" Pro Tect Coating Green

AccuForm Case Of 25

- PAR990-125** Case - 25 Complete 17" Head, 54" Honeycomb Handle Green
- PAR990-325** Case - 25 Complete 17" Head, 54" Hollow Handle Green
- PAR990-525** Case - 25 Complete 17" Head, 54" Aluminum Handle Green
- PAR990-825** Case - 25 Complete 17" Head, 54" Pro Tect Coating Handle Green
- PAR990-1025** Case - 25 Complete 17" Head, 54" Aluminum Handle Brown
- PAR990-925** Case - 25 Complete 17" Head, 72" Pro Tect Coating Handle Green
- PAR995-125** Case - 25 Complete 25" Head, 54" Honeycomb Handle Green
- PAR995-325** Case - 25 Complete 25" Head, 54" Hollow Handle Green
- PAR995-525** Case - 25 Complete 25" Head, 54" Aluminum Handle Green
- PAR995-825** Case - 25 Complete 25" Head, 54" Pro Tect Coating Handle Green
- PAR995-1025** Case - 25 Complete 25" Head, 54" Aluminum Handle Brown
- PAR995-925** Case - 25 Complete 25" Head, 72" Pro Tect Coating Handle Green

Rake Heads Only

- PAR990-01** 17" Accuform Ace II Rake Head
- PAR995-01** 25" Accuform Ace II Rake Head

Accuform Handles and Grips Only

- PAR972-1** Handle Accuform 54" Honeycomb Green
- PAR972-5** Handle Accuform 54" Hollow Green
- PAR972** Handle Accuform 54" Aluminum Green
- PAR972-10** Handle Accuform 54" Aluminum Brown
- PAR972-8** Handle Accuform 54" Pro Tect Coating Green
- PAR972-6** Handle Accuform 72" Hollow Green
- PAR972-9** Handle Accuform 72" Pro Tect Coating Green
- PAR974-10** Accuform Rubber Grip only for 54" handles (package of 10)







**ACCUCURV BUNKER RAKE**



This 15" wide rake is made from super tough Co-polymer blend plastic with a dual action when flipped over. Plowing when pushed and smoothing the sand when pulled. Choose handle of your choice.



**Complete AccuCurv Rake**

- PAR997-1** 15" AccuCurv Head w / Handle Accuform 54" Honeycomb Green
- PAR997-3** 15" AccuCurv Head w / Handle Accuform 54" Hollow Green
- PAR997-5** 15" AccuCurv Head w / Accuform 54" Aluminum Green
- PAR997-10** 15" AccuCurv Head w / Accuform 54" Aluminum Brown
- PAR997-8** 15" AccuCurv Head w / Accuform 54" Pro Tect Coating Green
- PAR997-9** 15" AccuCurv Head w / Handle Accuform 72" Pro Tect Coating Green

**Rake Heads Only**

- PAR997-01** 15" AccuCurv Head

**AccuCurv Case Of 25 Complete**

- PAR997-125** Case - 25 Complete 15" Head, 54" Honeycomb Handle Green
- PAR997-325** Case - 25 Complete 15" Head, 54" Hollow Handle Green
- PAR997-525** Case - 25 Complete 15" Head, 54" Aluminum Handle Green
- PAR997-825** Case - 25 Complete 15" Head, 54" Pro Tect Coating Handle Green
- PAR997-1025** Case - 25 Complete 15" Head, 54" Aluminum Handle Brown



SIGNAGE

RANGE & PRACTICE

TEE AREA

FAIRWAY

GREENS

CLUBHOUSE, PRO SHOP, & TOURNAMENT

RECYCLED PLASTICS

SAFETY, MAINTENANCE, & IRRIGATION

SIGNAGE

RANGE & PRACTICE

TEE AREA

FAIRWAY

GREENS

CLUBHOUSE, PRO SHOP, & TOURNAMENT

RECYCLED PLASTICS

SAFETY MAINTENANCE, & IRRIGATION

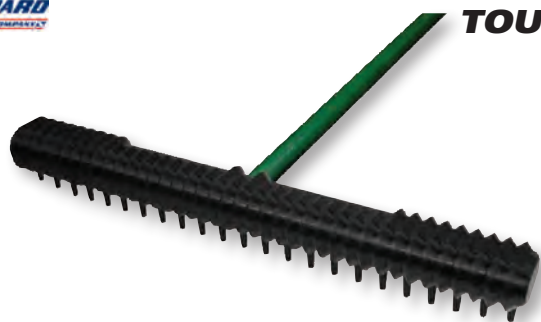

**TOUR PRO RAKE**

- ST11700** 54" Composite Handle - Green
- ST11720** 60" Gator Grip Handle - Green
- ST11730** 60" Gator Grip Handle - Brown
- ST11750** 64" Aluminum Curved Handle - Green

Priced individually. Gator Grip and composite handles sold in multiples of 12. Curved handles sold in multiples of 6.

When mediocrity isn't an option and only perfection will do, turn to Standard Golf's Tour Pro Bunker Rake. No other bunker rake can make smooth, level, playable surfaces like the Tour Pro.

- 20" (51 cm) and 25" (63 cm) heads ensure tracks are covered with minimum effort, while pioneering design generates tournament quality surfaces.
- When durability is a must, the exclusive Gator Grip Handle is your best option, available in both 60" (152 cm) and 72" (183 cm) lengths.
- A single self-tapping screw (included) is all you need for assembly.

- ST11770** 72" Gator Grip Handle - Green
- ST11780** 72" Gator Grip Handle - Brown

Priced individually. 72" Gator Grip handles sold in multiples of 6.



**GATOR GRIP HANDLE**

Toughness matched only by its namesake. Gator Grip Handles put an end to all the problems associated with degrading fiberglass rake handles.

- Specially formulated polymer coating adds durability and strength capable of withstanding even the worst conditions.
- No more splinters, chipping, peeling or cracking. Finally a bunker rake handle whose performance surpasses your expectations.
- Both 60" (152 cm) and 72" (183 cm) lengths fit Tour Smooth II, Tour Pro and Accuform bunker rake heads.

60" Handle - Green  
**ST11200**

72" Handle - Green  
**ST11210**

60" Handle - Brown  
**ST11201**

72" Handle - Brown  
**ST11211**

**TOUR-LITE™ RAKE**

This rake has the same curvature and teeth as the TOUR SMOOTH rake but is lighter weight for one handed use. Handle is plastic coated steel and 54" long with a 4" grip.

- ST12350** Rake With Yellow Ultralight Handle
- ST12375** Rake With Green Ultralight Handle
- ST12305** 54" Yellow Ultralight Steel Handle Only
- ST12306** 54" Green Ultralight Steel Handle Only
- ST12301** 15" Tour-Lite Head Only



**15" TOUR SMOOTH II RAKE**

- Smooths both fine and course sand into perfect playing conditions quickly and easily.
- Pair the Tour Smooth II with the exclusive 60" (152 cm) Gator
- Grip Handle for a level of performance unmatched by any of the competitors.
- A single self-tapping screw (included) is all you need for assembly.



- ST11800** 54" Composite Handle - Green
- ST11820** 60" Gator Grip Handle - Green
- ST11830** 60" Gator Grip Handle - Brown
- ST11850** 64" Aluminum Curved Handle - Green
- ST12200** 72" Composite Handle - Green

Priced individually. Gator Grip and composite handles sold in multiples of 12. Curved handles sold in multiples of 6.

Time-tested design and performance of the Tour Smooth bunker rake just got an upgrade. Improved rake assembly and the addition of the exclusive Gator Grip Handle makes the Tour Smooth II a must for all courses.

**"EZEE" BUNKER RAKES**



15" or 22" width head with plastic, wood, or heavy duty fiberglass handle.

Complete EZEE Rake

- F22015BLKF54G** Black 15" Rake Head w / 54" Green Handle
- F22022BLKF54G** Black 22" Rake Head w / 54" Green Handle

Rake Heads Only

- F22015BLK** 15" Rake Head - Black
- F22022BLK** 22" Rake Head - Black

Handles and Grips Only

- F220F54G** Fiberglass Rake Handle 54" Green
- F220GRIP6** 7 3/4" Replacement Grip

**RAKE HANDLE STICKERS**



Use an adhesive label to inform your patrons of your bunker rake procedures. Easy to apply they will clearly stand out for the golfer to see. Label is green on white. Sold in packs of 10.

- F218GW** Place Rake In Bunker
- F219GW** Place Rake Outside Bunker

SIGNAGE  
RANGE & PRACTICE  
TEE AREA  
FAIRWAY  
GREENS  
CLUBHOUSE, PRO SHOP, & TOURNAMENT  
RECYCLED PLASTICS  
SAFETY, MAINTENANCE, & IRRIGATION

**SABERTOOTH RAKE**

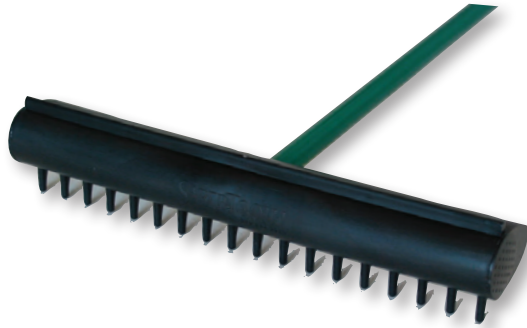

Sabertooth Handle

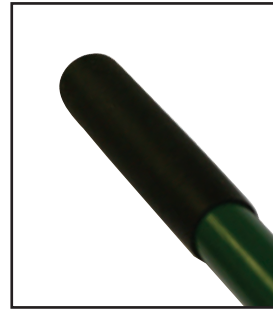

Sabertooth One Hand Grip



Sabertooth Golf Grip

Complete Sabertooth Rake

- F22616541** 16" Sabertooth Rake w / Handle 54" - 1 Hand Grip
- F22616542** 16" Sabertooth Rake w / Handle 54" - Golf Grip
- F2262654HDLG1** 26" Head w / Rake Handle 54" - 1 Hand Grip
- F2262654HDLG2** 26" Head w / Rake Handle 54" - Golf Grip

Rake Heads Only

- F22616** Sabertooth Rake Head 16"
- F22626** Sabertooth Rake Head 26"

Sabertooth Handles and Grips Only

- F22654HDLG1** Sabertooth Rake Handle 54" - 1 Hand Grip
- F22654HDLG2** Sabertooth Rake Handle 54" - Golf Grip
- F22666HDLG1** Sabertooth Rake Handle 66" - 1 Hand Grip
- F22666HDLG2** Sabertooth Rake Handle 66" - Golf Grip

Official



Licensed Product

Only one bunker rake is good enough to be officially licensed by the PGA TOUR.

Rake handles are guaranteed by the manufacturer to not splinter for two years and Sabertooth will warranty the rake handles from splintering for the expected five-year life of the handles.

**ULTRA RAKE**

Our 15" wide rake is impact-resistant, high-density polypropylene and has UV inhibitors! The patented head with unique teeth design leave the bunker smoother in less time!

\*1-YEAR WARRANTY ON HEAD.\* "Best Warranty in the Industry"

Handles are UV-inhibitor coated fiberglass and plugged on both ends for weatherproofing and enhanced life span. Comes with 54" Green Honeycomb Handle.

Complete Ultra Rake

- F224F54G** 15" Fiberglass Rake w / Handle 54" Green

Rake Heads Only

- F224** 15" Ultra Rake Head

Handles and Grips Only

- F220F54G** Fiberglass Rake Handle 54" Green
- F220GRIP** 7 3/4" Replacement Grip



SIGNAGE  
RANGE & PRACTICE  
TEE AREA  
FAIRWAY  
GREENS  
CLUBHOUSE, PRO SHOP, & TOURNAMENT  
RECYCLED PLASTICS  
SAFETY MAINTENANCE, & IRRIGATION

**SAND DANCER RAKE**

Complete Sand Dancer Rake

**F250BLKF54G** 15" Black Rake w / Handle 54" Green

**F25025BLKF54G** 25" Black Rake w / Handle 54" Green

Rake Heads Only

**F250BLKH** 15" Sand Dancer Rake Head - Black

**F25025BLK** 25" Sand Dancer Rake Head - Black

Handles and Grips Only

**F220F54G** Fiberglass Rake Handle 54" Green

**F220GRIP6** 7 3/4" Replacement Grip



F220 Replacement Grip  
7 3/4"



F220 Green



F220 Wood



25" Head

The Sand Dancer rake has an oval head that when pulled forward creates a beautiful smoothing effect. The teeth are 1/8" longer, and that creates a deeper penetration. Works great in coarse and fine grained sand.



**MVP RAKE**

Made from sturdy plastic this 15" wide rake presents a smoothing curve shape to the bunker sand. The handle is a 48" long plastic coated light gauge hollow steel offering durability and comfort.

**F232**



**DELUXE SAND TRAP RAKE**

**F233** 15" Head, 54" Handle

SIGNAGE

RANGE &  
PRACTICE

TEE AREA

FAIRWAY

GREENS

CLUBHOUSE,  
PRO SHOP, &  
TOURNAMENT

RECYCLED  
PLASTICS

SAFETY,  
MAINTENANCE,  
& IRRIGATION

SIGNAGE  
RANGE & PRACTICE  
TEE AREA  
FAIRWAY  
GREENS  
CLUBHOUSE, PRO SHOP, & TOURNAMENT  
RECYCLED PLASTICS  
SAFETY MAINTENANCE, & IRRIGATION

**WOOD RUGG RAKES**

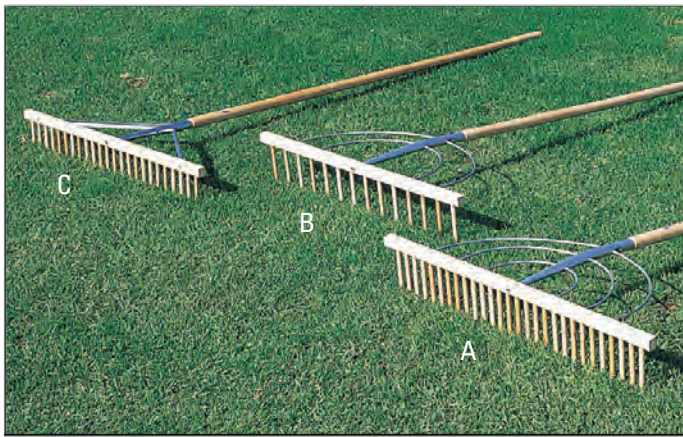

A - Lightweight construction perfect for collecting fallen leaves and branches. 28" wide, 28 teeth and 60" handle.

**F23539** Wood Lawn Rake

B - Lightweight construction for collecting lawn clippings and field mowings. 28" wide, 14 teeth and 60" handle.

**F23505** Wood Hay Rake

C - Levels, grades, sifts, and floats the surface level. A favorite of professional groundskeepers. 28" wide, 24 teeth, and 60" handle.

**F23560** Wood Gardening Rake

**F23562** 62" Wood Rake With Aluminum Teeth  
Replacement teeth come in boxes of 108 teeth.

**F236** Replacement Teeth For F23505 And F23539

**F237** Replacement Teeth For F23560

**F238** Replacement Wood Handle

**WOOD RUGG BUNKER RAKE**

Add some tradition to your course with this classic wood rake.

The lightweight construction makes it a pleasure for your patrons to use.

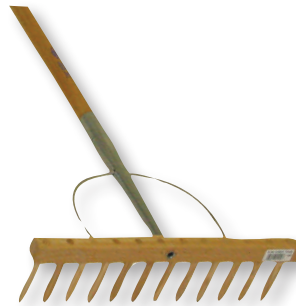

**F23519**  
Rake

**F237**  
Replacement Teeth

**DEBRIS RAKE**

This well known multi-purpose maintenance rake comprises tempered spring steel wire teeth mounted on a durable plastic head, handle is 60" heavy-duty fiberglass. The rake is ideal for removing debris from bunkers particularly pine needles, and final finishing of bunker sand.



**F242**  
Rake

**F242RK**  
Replacement  
Tines

**SAND COMB**

Now you can easily remove stones and debris from your sand bunkers using this light weight tool. The handle is made from tubular aluminum and the catcher has a choice of three sturdy interchangeable galvanized mesh sizes to meet your needs. The edge has a patented double angled design to separate debris from sand.

- F2461/4** 16" Sand Comb 1/4" Mesh
- F2461/2** 16" Sand Comb 1/2" Mesh
- F2471/4** 22" Sand Comb 1/4" Mesh
- F2471/2** 22" Sand Comb 1/2" Mesh



**LANDSCAPE RAKES**

Very strong extended aluminum head. Large grading edge. Self-cleaning teeth and aluminum handles.

- F22524** 24" Wide Head
- F22530** 30" Wide Head
- F22536** 36" Wide Head
- F22542** 42" Wide Head



**CHAIN**

**C251** Chain Master Link

Strong and durable plastic chain. Available in 3 sizes and 500ft in length. Variety of colors to choose from. Sold per ft.



**C250**  
Snap Hook Chain  
Connections



**C252** "S" Hooks



**F2051** 1"  
**F205125** 1 1/2"  
**F2052** 2"

**ROPE**



White



Yellow



Black



Hunter Green with White

**HOLLOW BRAID**

This popular rope is made of polypropylene and can be easily rejoined by feeding inside itself and pulling tight eliminating unsightly knots. Available in 1/4" and 1/2" widths. 5000 ft spool available on request.

**TWISTED**

Three strand polypropylene. Yellow, white, and green and white available in 600' lengths.

**F2001/4** 1/4"

**1/2" ROPE**

At various locations around the course you may want to consider 1/2" rope over typical 1/4" rope. Many customers have found 1/2" rope gives a more distinctive and purposeful look which may be good around the clubhouse for example.

- F1901/4BLK** 1/4" Black per 1000 Ft.
- F1901/4HG** 1/4" Hunter Green per 1000 Ft.
- F1901/4W** 1/4" White per 1000 Ft.
- F1901/4Y** 1/4" Yellow per 1000 Ft.
- F1901/4HGW** 1/4" Hunter Green with White per 1000 Ft.
- F1901/2BLK** 1/2" Black per 500 Ft.
- F1901/2HG** 1/2" Hunter Green per 500 Ft.
- F1901/2W** 1/2" White per 500 Ft.
- F1901/2Y** 1/2" Yellow per 500 Ft.
- F1901/2HGW** 1/2" Hunter Green with White per 500 Ft.



**ROPE FIDS**

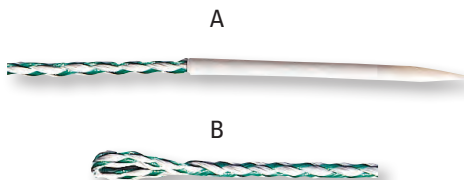

A - Plastic "FID" for joining or putting "Eyes" in the end of hollow braid rope.

B - Example of creating loop to connect two ends together eliminating knots in hollow braid rope.

**F189** 1/4" Fid  
**F1891/2** 1/2" Fid

**ROPE STAKES**

Since the creation of the first GreenWood™ stake by Eagle One in 1992, the line has grown immensely. We offer over 100 options catering to every golf course need. Please review the following pages to fill your needs.



SIGNAGE

RANGE & PRACTICE

TEE AREA

FAIRWAY

GREENS

CLUBHOUSE, PRO SHOP, & TOURNAMENT

RECYCLED PLASTICS

SAFETY MAINTENANCE, & IRRIGATION

**SQUARE**



F203 Speed Slot

F204 Hole

Speed Slots

- F20312** 12"
- F20318** 18"
- F20324** 24"

Holes

- F20412** 12"
- F20418** 18"
- F20424** 24"

Hooks

- F20412H** 12"
- F20418H** 18"
- F20424H** 24"





**TRADITIONAL ROPE AND CHAIN STAKES**

These 2 x 2 GreenWood™ square posts, will not rust, never need painting and are almost unbreakable. They float in water and have a steel spike, making relocation easy while providing a “dug in” solid look to the golfer. Available in Green, White, Brown and Black.

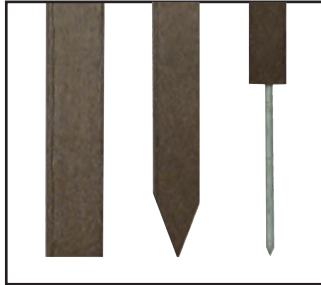

Blunt, Pointed and Spiked Bases.



F210 Hook

F211 Hole

F212 Speed Slot

Available Colors



Black

Brown

Green

White

12" With Hook (Installed)  
**F21012**

18" With Hook (Installed)  
**F21018**

24" With Hook (Installed)  
**F21024**

12" With Hole  
**F21112**

18" With Hole  
**F21118**

24" With Hole  
**F21124**

12" With Speed Slot  
**F21212**

18" With Speed Slot  
**F21218**

24" With Speed Slot  
**F21224**



SIGNAGE  
RANGE & PRACTICE  
TEE AREA  
FAIRWAY  
GREENS  
CLUBHOUSE, PRO SHOP, & TOURNAMENT  
RECYCLED PLASTICS  
SAFETY MAINTENANCE, & IRRIGATION

**ROUND ROPE STAKES**

Available Colors



Black Green White

The same low maintenance stake in a larger, easier to see design. 2 1/4" diameter. Pick your style: hole, hook or speed slot. Spike or blunt only. Hook attachment available upon request.

Hole		Speed Slot	
<b>F26112</b>	12"	<b>F26012</b>	12"
<b>F26118</b>	18"	<b>F26018</b>	18"
<b>F26124</b>	24"	<b>F26024</b>	24"



F260 Speed Slot

**EMPIRE TOP**

4" x 4" rope stakes made from our durable GreenWood™. This style offers a more distinctive or purposeful look for perfectly maintained areas of your golf course. Available in 12", 18", and 24" lengths. With a hook or hole for the rope. Includes a steel anchor spike.

- F21712H** Empire 12" With Hook (installed)
- F21718H** Empire 18" With Hook (installed)
- F21724H** Empire 24" With Hook (installed)
- F21712O** Empire 12" With Hole
- F21718O** Empire 18" With Hole
- F21724O** Empire 24" With Hole



**CHAMFERED TOP**

Available Colors



Black Brown Green White

- F21412CH** 4" x 4" x 12" With Hook (installed)
- F21418CH** 4" x 4" x 18" With Hook (installed)
- F21424CH** 4" x 4" x 24" With Hook (Installed)
- F21412CO** 4" x 4" x 12" With Hole
- F21418CO** 4" x 4" x 18" With Hole
- F21424CO** 4" x 4" x 24" With Hole

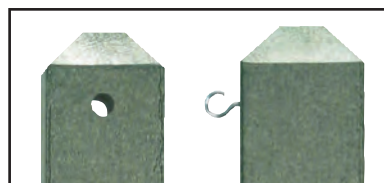

Hole

Hook



**"TRADITIONAL" - SQUARE OUT OF BOUNDS  
AND HAZARD MARKERS**

Durable, non rotting, maintenance free and just about unbreakable, they float in water and never need painting. Steel spikes makes placement/removal a breeze and any length stake can be made.

Available in Red, White, Green, Blue and Yellow.  
Also available in 2"x 4" and 4"x 4".

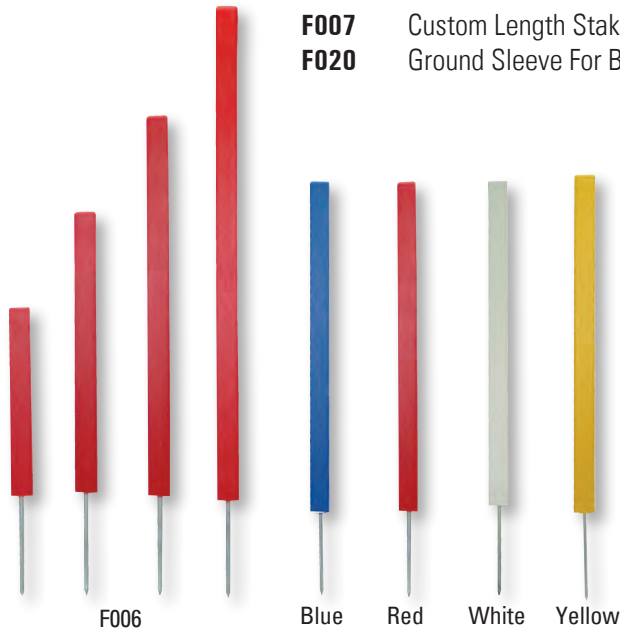

**F007** Custom Length Stake  
**F020** Ground Sleeve For Blunt Stakes



Blunt, Pointed and Spiked Bases.

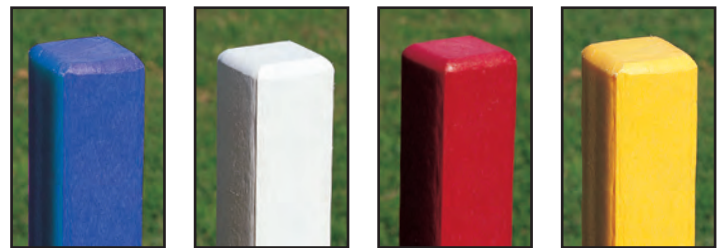

2 x 2 Markers

**F00612** 12" Spiked  
**F00618** 18" Spiked  
**F00624** 24" Spiked  
**F00632** 32" Spiked

**F00418** 18" Blunt  
**F00424** 24" Blunt  
**F00432** 32" Blunt

**F00518** 18" Pointed  
**F00524** 24" Pointed  
**F00532** 32" Pointed

**SQUARE BUDGET BEATER HAZARD / DISTANCE MARKERS**

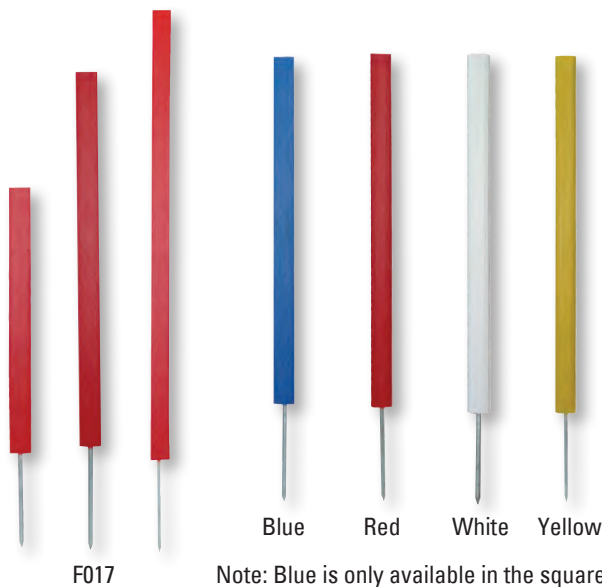

Note: Blue is only available in the square style.

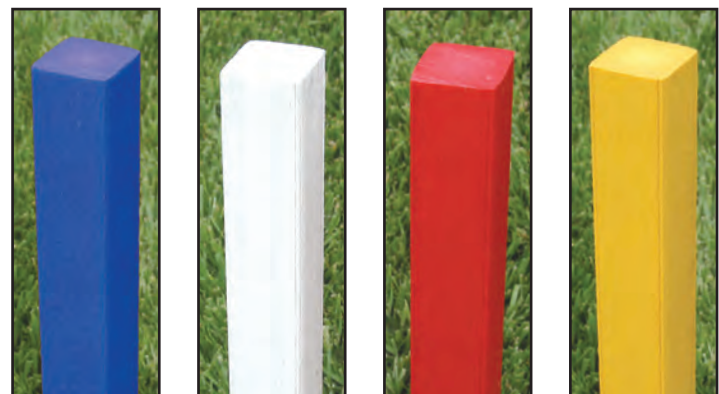

**F01712** 12"  
**F01718** 18"  
**F01724** 24"  
**F01732** 32"

SIGNAGE

RANGE &  
PRACTICE

TEE AREA

FAIRWAY

GREENS

CLUBHOUSE,  
PRO SHOP, &  
TOURNAMENT

RECYCLED  
PLASTICS

SAFETY,  
MAINTENANCE,  
& IRRIGATION

SIGNAGE  
RANGE & PRACTICE  
TEE AREA  
FAIRWAY  
GREENS  
CLUBHOUSE, PRO SHOP, & TOURNAMENT  
RECYCLED PLASTICS  
SAFETY MAINTENANCE, & IRRIGATION



**TRAFFIC DIVERTERS**

Utilizing 4"x4" GreenWood™ and a steel spike these come in 12" and 18" high posts can be grouped closely to direct cart and foot traffic away from sensitive areas. Three styles of top decoration are available as shown and colors include

green, white, driftwood, blue, red, black, brown and yellow. Due to the numerous combinations custom production of your order may be required. Custom lengths also available.

- F215C** 12" Chamfered Top
- F21518C** 18" Chamfered Top

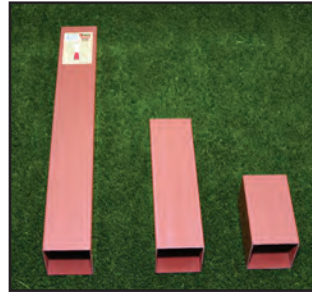

**PVC SLEEVE**

Many of you have wanted an in-ground sleeve for your 4" x 4" GreenWood™ posts. This PVC plastic sleeve come in three different sizes, 7", 14" and 28" long and they are the perfect size for the task.

- F132S** 4 x 4 x 7"
- F135S** 4 x 4 x 14"
- F133S** 4 x 4 x 28"

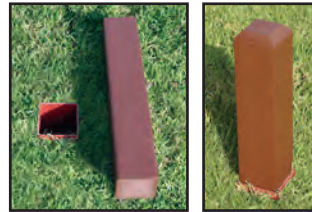

**YARDAGE AND HAZARD MARKERS**

These fairway markers will give your course an upscale look with their brown GreenWood™ bottoms and colored tops. Available with red, white, yellow, and blue tops.

- F13018** 18"



**VERTICAL DISTANCE MARKER POSTS**

Attractive, durable 100% solid, GreenWood™ are low maintenance and require no painting. Various colors include red, white, and blue. Available either blank or with engraved numbers on two sides.

- F131**  
Blank  
4"x4"x5'

- F131RT**  
Reflective  
Vinyl

- F132**  
Numbered  
4"x4"x5'

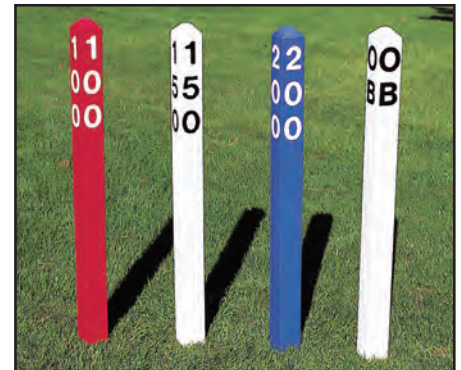

**LAMINATED PLASTIC MARKERS**

For clarity these course markers are spectacular. They are made from super durable engraved laminated plastic with two steel support spikes. We can customize the wording to your needs or choose from the list below.



- F3160B** OB
- F316100** 100 Marker
- F316150** 150 Marker
- F316200** 200 Marker
- F316250** 250 Marker
- F316Carts** Carts
- F316NC** No Carts
- F316Hazard** Hazard



**GREENWOOD™  
YARDAGE MARKERS**

Made of Greenwood™, the numbers can be engraved and backfilled, or displayed with a lexan insert. These round posts are perfect for designating yardages to the green. They are 33" long and come with a spike for easy placement.

**F145** Post With Engraved Numbers

**F146** Post With Lexan Numbers

**F145T** Two-Tone Post With Engraved Numbers

**F146T** Two-Tone Post With Lexan Numbers



**RE-FLEX STAKES**

This stand up marker can be run over in any direction without any damage. A simple but effective design with 1" PVC piping that gets buried into the ground, exposing Red, White, or Blue hazard markings.



**F01124**  
12" Vinyl  
Fairway Marker

**"FLEXSTAKE" MOW-OVER VERTICAL  
YARDAGE / HAZARD MARKERS**



Internal  
Support  
Post  
For F118  
Markers

These unique markers are made of a two chamber, color impregnated, polycarbonate extrusion post, special flexible joint and stake. This design allows marker to be mowed over by reel type mower saving the need of removal during mowing or trimming around later. Damage may occur if run over by the tire instead of mower. If required, ground anchors can be supplied for easy removal/replacement. Posts are available in 18", 24" and 36" lengths. Number transfers are shipped unattached for protection during transit.

Internal posts and yardage markers sold separately.

**INTERNAL SUPPORT  
POSTS**

- F01217** 17.5" Posts
- F01224** 24" Posts
- F01236** 36" Posts
- F118GA** Ground Anchor

**YARDAGE MARKER SLEEVE**

- F11818** 18" High Yardage Marker
- F118D** Yardage Decals (not installed)



Yardage Marker on F012  
Internal Support Post.

SIGNAGE

RANGE &  
PRACTICE

TEE AREA

FAIRWAY

GREENS

CLUBHOUSE,  
PRO SHOP, &  
TOURNAMENT

RECYCLED  
PLASTICS

SAFETY,  
MAINTENANCE,  
& IRRIGATION

**YARDAGE INDICATOR TUBES**

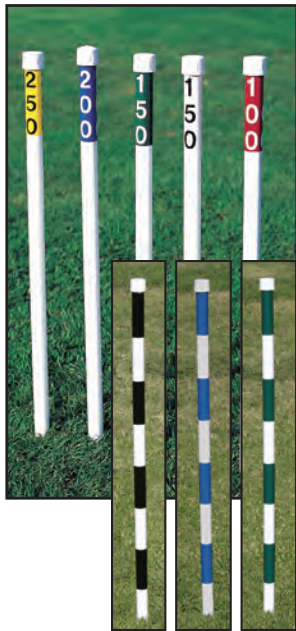

1-3/8" diameter plastic tubes with 1/4" thick walls. Tubes are 40" high and have colored top of your choice and yardage numbers and barber shop style. Ground sleeves are available.

- F143**  
Numbered Post
- F143BP**  
Barber Shop Style Post
- F143S**  
Ground Sleeve

**3 1/2" DIAMETER X 48" LONG VERTICAL DISTANCE MARKER**



Barber Shop Style

Colored Tops Only, White Base, No Numbers - 48"

- F129C** Red, White or Blue
- F129CC** Custom Color

Colored Tops Only, White Base, With Numbers - 48"

- F129CN** Red, White or Blue
- F129CNC** Custom Color With Numbers

Striped

- F129BP** Barber Shop Style

Ground Sleeve

- F120S** 18" Ground Sleeve

**CAPS FOR MARKERS**

These colored vinyl sleeves slip over your choice of stake allowing you to designate the desired usage in the way you like. This product is made to order and can only be used with square profile stakes.

**F008** 3 1/2" Tops (installed)



**3 1/2" DIAMETER X 33" LONG VERTICAL DISTANCE MARKER**

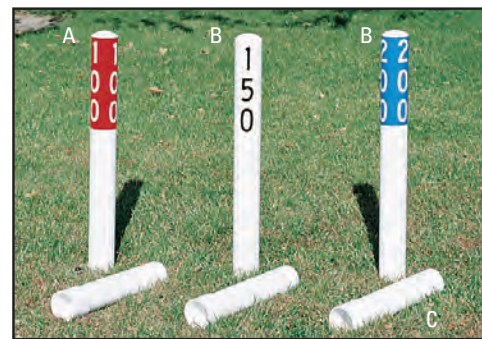

A. Colored Tops Only, White Base, No Numbers - 33"

- F127C** Red, White or Blue
- F127CC** Custom Color

Colored Tops Only, White Base, With Numbers - 33"

- F127CN** Red, White or Blue
- F127CNC** Custom Color With Numbers
- F127BP** Barber Shop Style

Plain Colored Tubes, No Numbers - 33"

- B. **F127P** Red, White or Blue
- F127PC** Custom Color

Plain Colored Tubes With Numbers - 33"

- F127PN** Red, White or Blue
- F127PNC** Custom Color With Numbers

Ground Sleeve

- C. **F120S** 18" Ground Sleeve

Shatter proof, UV inhibited (10 year warranty for UV break down) 31/2" dia. round plastic posts. Choice of plain red, white or blue or numbered on red, white or blue. Post either 48" long or 33" with optional 18" ground sleeve for easy removal and replacement. Coloring can be full length or top stripe only. Custom coloring available. Note: Ground sleeve is sold separately.

SIGNAGE  
RANGE & PRACTICE  
TEE AREA  
FAIRWAY  
GREENS  
CLUBHOUSE, PRO SHOP, & TOURNAMENT  
RECYCLED PLASTICS  
SAFETY MAINTENANCE, & IRRIGATION

**HORIZONTAL CART PATH AND  
FAIRWAY DISTANCE MARKERS**

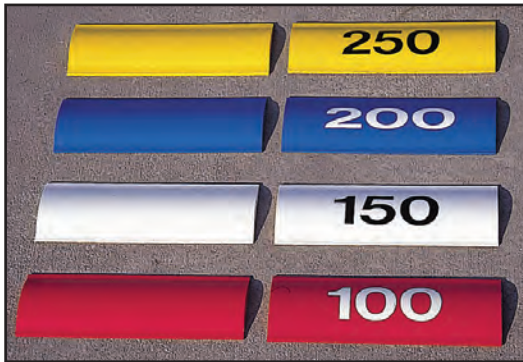

- F153** 4" x 12" Plain Rectangular
- F154** 4" x 12" Numbered Rectangular



**PLASTIC CART PATH MARKERS**

- F151**  
4" Plain Round
- F152**  
4" Numbered Round

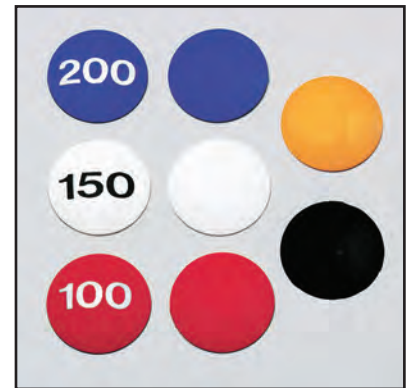

Both these markers are made of solid plastic and glue down on path with special epoxy glue. Mark path with color code or engraved numbers. We can customize numbers or wording

**EPOXY GLUE**

Two part glue necessary to adhere F151, F152, F153 and F154 markers to the surface.

- F162** 2 Gallon Set

**STENCILS**



These stencils are made from super durable, laser-cut PVC, not your run-of-the-mill paper. They can be used over and over for years, are simple to use and can be customized for your numbers or wording. Numbers are 6" high for good visibility. Stencils sold individually.

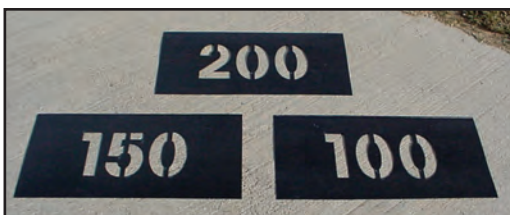

**MARKING  
PAINTS**

- R262**  
Easy Marker
- R240**  
Traffic Paint



- F05050** 50 Yardage
- F05075** 75 Yardage
- F05090** 90 Degrees
- F050100** 100 Yardage
- F050125** 125 Yardage
- F050150** 150 Yardage
- F050175** 175 Yardage
- F050200** 200 Yardage
- F050225** 225 Yardage
- F050250** 250 Yardage

- F050C <** Carts - Arrow Left
- F050C** Carts - Two Way Arrow
- F050C >** Carts - Arrow Right
- F050CA** Caution Speed Bump
- F050CU** Carts - Arrow Up
- F050OB** Out Of Bounds
- F050SL** Slow
- F050C** Custom Stencils

**GRUND GUIDE MARKING SYSTEMS**



SPEED AND QUALITY OF PLAY...GOLF AS IT SHOULD BE.

You know Grund Guide for making premier yardage marking solutions. Now backed with the strength of Underhill® distribution and product development, you can have the highest quality and most complete yardage marking systems available today and into the future. We offer durable and high-visibility customized markers for all popular golf sprinklers along with unique fairway, tee box, and driving range markers. Speed up and improve the quality of play with Grund Guide Marking Systems.

**SPRINKLER HEAD YARDAGE MARKERS**

	<p>Model SPM 106 - <b>TORO</b> Engraved Caps: Perfect-fit caps engraved and color filled for high visibility. Multiple number locations vary for lids with holes.</p>	<p>FITS: <b>Toro 730, 750, 760, 780, 830/850S, 834S, 835S, DT34/35S, 854S, DT54/55, 860S, 880S</b>                  COLORS: Caps - l/m/l/l                  Numbers - m/l/l/l/l/l/l</p>
	<p>Model SPM 107 - <b>Rain Bird</b> Engraved Caps: Perfect fit caps engraved and color filled for high visibility number identification.</p>	<p>FITS: <b>Rain Bird E900, E950, E700, E750, E500, E550, 700, 751, 51DR</b>                  COLORS: Caps - l/m/l/l                  Numbers - m/l/l/l/l/l/l</p>
	<p>Model SPM 110 - <b>Hunter</b> Engraved Caps/Covers: Perfect-fit flange covers (G800, G900) and caps (G90), engraved and color filled for high visibility.</p>	<p>FITS: <b>Hunter G800, G900, G90</b>                  COLORS: Flange cover / caps - l                  Numbers - m/l/l/l/l/l/l</p>
	<p>Model SPM 101 - Fit Over Discs: Anodized aluminum (no paint!), these markers are engraved and custom fit to each sprinkler. Multiple number locations vary for lids with holes.</p>	<p>FITS: <b>Toro 630, 650, 660, 670, 680, 690, 830/850S, 834S, 835S, DT34/35, 854S, 855S, DT54/55, 860S, 880S, Rain Bird 47/51 DR, 71/91/95, E900, E950, E700, E750, E500, E550, 1100, Hunter G-70/75, G-90/95, G-990, G-995, John Deere/Signature – Call</b>                  COLORS: Discs - l/l/l, Numbers - l</p>
	<p>Model SPM 105 - Universal Tags: Anodized aluminum (no paint!), these markers are engraved and designed for most universal fit applications. Tags are installed using 1/8" rivets.</p>	<p>FITS: Universal - Options: Crescent 2-7/8"W x 1"H, Round Edge 3"W x 1"H, Square Edge 2"W x 3/4"H                  COLORS: Tags - l/l/l                  Numbers - l</p>
	<p>Model SPM 103 - <b>TORO</b> Snap-In Markers: <b>OEM UPGRADE</b> to high quality polycarbonate custom fit. One complete, high-visibility marker snaps into OEM plug.</p>	<p>FITS: <b>Toro 730, 750, 760, 780, 830/850S, 834S, DT34/35, 854S, DT54/55, 860S, 880S</b>                  COLORS: Snap in - m/l/l, Numbers - m/l (Reclaimed water option - l no number - available)</p>
	<p>Model SPM 108 - <b>TORO &amp; Hunter</b>: Special engraved plastic material designed to fit into OEM lid recess</p>	<p>FITS: <b>Toro 730, 750, 760, 780, 834S, DT34/35, 854S, DT54/55, 860S, 880S</b> and <b>Hunter G800, G70/75B, G870, G875, G880, G885, G990, G995</b>                  COLORS: Markers - m/l, Numbers - l</p>
	<p>Model SPM 104 - Lid/Molded Recess Markers: Durable replacement lid, with reverse engraved number insert process. Excellent number ID with this model</p>	<p>FITS: <b>Rain Bird 47, 51</b>                  COLORS: Lid - l/m/l                  Insert - m/l/l                  Numbers - m/l</p>
	<p>Model SPM 102 - <b>Rain Bird</b> Yardage Highlighter Snap-Ring: Replaces OEM snap ring with perfect fit bright yardage and reclaimed color identification.</p>	<p>FITS: <b>Rain Bird E900, E950, E700, E750, E500, E550, 700, 751</b>                  COLORS: m/l/l (Reclaimed Water)</p>

Identify the Manufacturer of your irrigation system. • Identify the series number of your head(s) to be marked. • Choose your appropriate style from above. • Your order will have seven components

Ordering Tips:

(ie.)	SPM 107	Rainbird	700	Black	White	1	76
	Code	Manfr.	Series	Color of Lids	Color of #s	Quantity of #s	Quantity of Parts

SIGNAGE  
RANGE & PRACTICE  
TEE AREA  
FAIRWAY  
GREENS  
CLUBHOUSE, PRO SHOP, & TOURNAMENT  
RECYCLED PLASTICS  
SAFETY MAINTENANCE, & IRRIGATION



**FAIRWAY / TEE / RANGE DISC MARKERS**

Large 7 1/2" cap with big bold 3 1/2" standard yardage numbers. Ideal for fairway, tee and driving range marking. Optional 8" mounting pipe attachment available for secure installation.

**FAIRWAY STANDARD DISC SYSTEM**

Color-coded markers with bold 3 1/2" yardage number. Several system options available.



**FAIRWAY CUSTOM OPTIONS**  
Markers can be customized to display specific yardage numbers, include logos, or custom design.



**TEE BOX / DRIVING RANGE CUSTOM OPTIONS**  
Markers can be customized to display specific multiple numbers, include logos, or custom design.

**SYSTEM EXAMPLES**

- A: 3 markers placed down the center of the fairway at 50 yard intervals
- B: 5 markers placed down the center of the fairway for greater coverage
- C: Markers placed on sides and center ("diamond" layout) for highest visibility
- D: Create a custom system with your choice of color and numbers/markings

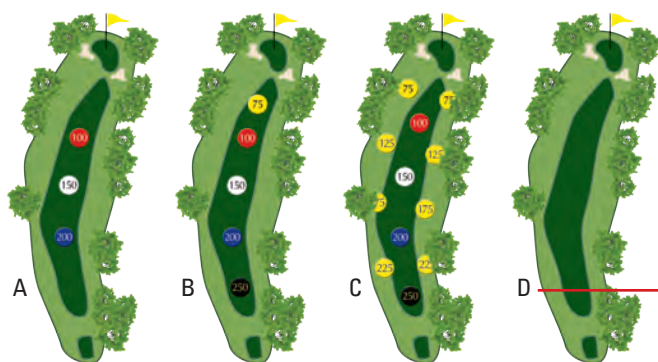

**VALVE BOX / UNIVERSAL MARKERS**

These engraved, anodized aluminum (no paint!) markers are ideal for isolation or control valves, satellites or other applications.

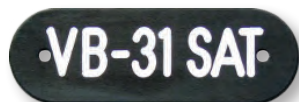

Disc Marker pictured with optional 8" mounting pipe (installs easily with standard cup cutter)

**ORDERING**

<b>Standard Disks with Markings</b>	
FTM-Y-75	Yellow Disk with 75
FTM-R-100	Red Disk with 100
FTM-W-150	m White Disk with 150
FTM-BL-200	Blue Disk with 200
FTM-BK-250	Black Disk with 250
FTM-RWB-KIT	3 Disks with Yardages (l/m/l)
FTM-YRWBB-KIT	5 Disks with Yardages (l/l/m/l/l)

• **Custom Disks for Fairway, Tee Box and Driving Range**

FTM-Y	Yellow Disk no markings
FTM-O	Orange Disk no markings
FTM-R	Red Disk no markings
FTM-W	m White Disk no markings
FTM-BL	Blue Disk no markings
FTM-BK	Black Disk no markings
FTM-G	Green Disk no markings
FTM-L	Lavender Disk no markings

**Tee Box / Fairway / Driving Range Custom Markings**  
To order, add to end of custom disk part numbers above.  
Example: FTM-Y-#1 (Yellow Disk with One custom number)

XXXX-#1	One custom number to disk
XXXX-#2	Two custom numbers to disk
XXXX-#3	Three custom numbers to disk
XXXX-CUST	Custom Design; Script
XXXX-LOGO	Logo added to disk
XXXX-#4	up to 4 flags / targets / yardages
XXXX-#8	5 to 8 flags / targets / yardages
XXXX-#12	9 to 12 flags / targets / yardages

**Accessories**  
FTM-PL 8" Mounting Pipe for all disks

**Valve Box / Universal Markers**  
SPM-105-B Black anodized marker  
SPM-105-M Maroon anodized marker

SIGNAGE  
RANGE & PRACTICE  
TEE AREA  
FAIRWAY  
GREENS  
CLUBHOUSE, PRO SHOP, & TOURNAMENT  
RECYCLED PLASTICS  
SAFETY, MAINTENANCE, & IRRIGATION

SIGNAGE  
RANGE & PRACTICE  
TEE AREA  
FAIRWAY  
GREENS  
CLUBHOUSE, PRO SHOP, & TOURNAMENT  
RECYCLED PLASTICS  
SAFETY MAINTENANCE, & IRRIGATION

**"SOFT-TOP" MUSHROOM MARKER**



These markers have 14" diameter tops that collapse under load. This allows them to stand higher in the fairway for greater visibility but set down under the load of the lawn mower and reduce bounce by golf balls compared to hard surfaces. Available in red, white, blue and yellow.

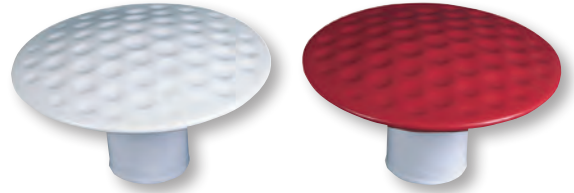

- F159** Complete Marker
- F159T** Replacement Top
- F159RB** Replacement Bottom

**PLASTIC DIG-IN YARDAGE MARKERS**

Extremely durable and good looking these yardage markers are made from two tone 3/4" solid plastic. Numbers are routed down in the face so they cannot be destroyed. Color face choices include red, white, blue, green, and yellow.

**F092** 15 1/2" Plain Round

**F093** 15 1/2" Numbered Round

**F135** 8"x12" Plain Rectangular

**F136** 8"x12" Numbered Rectangular



**FusionCast™**  
ENGINEERED METAL CASTING TECHNOLOGY

**FUSFAIR** Call For Quote

**GREENWOOD™  
YARDAGE PLATE**

**YARDAGE MARKERS**



This plastic plate is dug into the ground and held in place by two spikes. Customize numbers to your yardage requirements. 12"x 9" x 1 1/2"

**F134C** Call For Quote

**KIRBY YARDAGE MARKERS**



Eagle One can now help you with all of your Kirby Marker needs. Kirby Markers are a highly visible fairway marking system known the world over. These pop-up, mow-over markers can speed up play by up to 1/2 hour per player. Faster rounds mean more revenue. Kirby Markers are the real answer to "cart path only" conditions. Call us to discuss your needs.

- F110** Kirby Marker Complete
- F110IK** Installation Kit  
(Turf Cutter and Pound Plate)
- F110T** Replacement Top
- F110RC** Collars
- F110AP** Anchor Pipe



**F110** Kirby Marker



**F110C** Custom Color/Number  
Call To Discuss

**CART DIRECTION BARRIERS**

This easy to read barrier serves as an interesting alternative to traditional styles. An angled, GreenWood™ post is engraved with your message then color filled for an optimal read and exceptional durability.

Made of GreenWood™. Maintenance free, durable, and almost unbreakable. Available in multiple colors. Signs are not included.



**F3286**  
4" x 4" x 6'



**F3284**  
4" x 4" x 4'



SIGNAGE  
RANGE & PRACTICE  
TEE AREA  
FAIRWAY  
GREENS  
CLUBHOUSE, PRO SHOP, & TOURNAMENT  
RECYCLED PLASTICS  
SAFETY MAINTENANCE, & IRRIGATION

**FAIRWAY DRAG NETS**

Drag nets allow mowing any time, even after rain. Prevents clumping and matting. Keeps fairways beautifully groomed. Saves time and reduces the chance of "dollar spot" and other turf diseases. Grass blades are forced to stand up. Styles to fit all major mower models. Please provide mower type when ordering. 3 - 4 weeks for delivery. Usually Drop Shipped - additional freight charges may apply.

**F670N** Fairway Drag Net Only Call For Quote



**FAIRWAY SNAKE**

The fairway snake is a weighted line that is towed by two vehicles up a fairway. The weighted line knocks down the dew, breaks up grass clippings, reduces disease pressure and stands up the turf for a better cut. Polypropylene outside, lead core inside. Weight is 1/2lb per foot. Usually Drop Shipped - additional freight charges may apply.

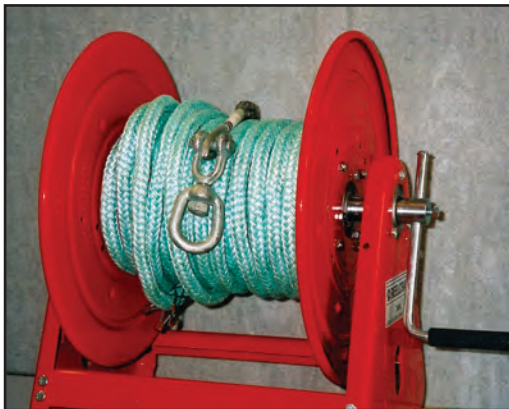

- F660100** 100' Long
- F660150** 150' Long
- F660200** 200' Long
- F660C** Custom Length
- CA30112L** Reel



**TURF SHIELD ROOT PROTECTION**

Applying

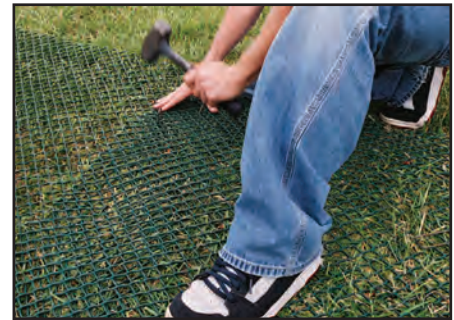
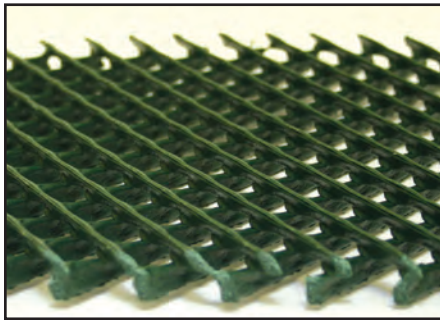

This grass protection system is a tough extruded polymer grid for reinforcing grassed areas used by vehicles and pedestrians. For best results the mesh should be laid down in Spring when the grass will grow quickly through the mesh and the root mass will form an interlock with the mesh filaments. The protected grassed areas will soon resume their natural appearance providing a stable surface which will withstand the weight of lightweight vehicles and heavy pedestrian use.



Product laid, ready for the turf to grow through.

After

**Applications:**

- Grassed access routes
- Footpaths
- Cart paths

**F35560**

6.7' x 60' Roll

**BUNKER LINER**

Known as Bunker-Aid plus, this highly efficient liner is 100% synthetic and includes a scrim backing to offer even more durability. Features include reduced wash outs, reduced silt contamination, increased golf course design flexibility, easy installation and reduced labor / maintenance.

Usually Drop Shipped - additional freight charges may apply.

**F4256** 6' Wide x 50' Long

**F425S** Box of 1000 Staples

Before



After



SIGNAGE

RANGE &  
PRACTICE

TEE AREA

FAIRWAY

GREENS

CLUBHOUSE,  
PRO SHOP, &  
TOURNAMENT

RECYCLED  
PLASTICS

SAFETY,  
MAINTENANCE,  
& IRRIGATION

SIGNAGE  
RANGE & PRACTICE  
TEE AREA  
FAIRWAY  
GREENS  
CLUBHOUSE, PRO SHOP, & TOURNAMENT  
RECYCLED PLASTICS  
SAFETY MAINTENANCE, & IRRIGATION

**GREEN FLAGS**



Our 13" x 19" flags are manufactured from "400 Denier" weight nylon cloth. This is a heavier material than normally used within the industry. This weight is far more durable, fades much slower, and displays screened graphics more clearly. Flags have four rows of stitching on the trailing edge and corner cross stitching. Customizing with your logo or sponsor requirement can be either with screen printing or embroidery.

Need a logo? Let us design it for you.

Strong Wind Area?

We have developed some unique flag designs for heavy wind areas that slow the flag resonance. Please call to discuss.

Flags are hand-stitched, and therefore they can vary slightly.

**PLAIN FLAGS & SAMPLE COLORS**



Sample colors shown are approximate, and can vary slightly.

**TUBE ASSEMBLY**



**G790PX**  
Plain Two Tone Diagonal Cut Flags



**G790NX**  
Numbered Two Tone Diagonal Cut Flags  
Sold in sets of 9 only.



**G700** Plain Tube Flag



**G905** Numbered 1-9  
Sold in sets of 9 only.



**G910** Numbered 10-18  
Sold in sets of 9 only.

**GROMMET ASSEMBLY**



**G705** Plain Grommet Flag



**G915** Numbered 1-9  
Sold in sets of 9 only.



**G920** Numbered 10-18  
Sold in sets of 9 only.

### SOFT POCKET ASSEMBLY



Soft Pocket style regulation and practice green flags create a great new sleek look for your course. These pocket style flags have super strong canvas reinforcing with top grommet where the PVC tubes go on conventional flags. Soft Pocket's allow the flags to be washed with mild detergent and are available in all of our flags styles- plain, custom embroidered or silk-screened, checkered and practice green. Soft Pocket available on all flags at no extra charge.

GP700

### PLAIN SCREEN PRINTED FLAGS



G720 Screen Printed Tube Flag\*



G725 Screen Printed Grommet Flag\*

\* A setup fee may apply to new customers. One Color Flags - Add cost per additional color.



G630H  
Handicap Flag On Tube

PLEASE NOTE:  
With the purchase of 27 custom screen printed flags you will receive 9 more flags at no charge!

Flags are standard on a tube. Specify if required with grommets.

### PLAIN EMBROIDERED FLAGS



G710 Embroidered Tube Flag



G715 Embroidered Grommet Flag

Our embroidery is unique in that the reverse side, contrary to most, is visually the same as the front side. This saves having expensive two ply flags. Embroidered flags are all done "in-house", providing our customers with quick turnaround times.

Flags are standard on a tube. Specify if required with grommets.

SIGNAGE

RANGE &  
PRACTICE

TEE AREA

FAIRWAY

GREENS

CLUBHOUSE,  
PRO SHOP, &  
TOURNAMENT

RECYCLED  
PLASTICS

SAFETY,  
MAINTENANCE,  
& IRRIGATION

SIGNAGE  
RANGE & PRACTICE  
TEE AREA  
FAIRWAY  
GREENS  
CLUBHOUSE, PRO SHOP, & TOURNAMENT  
RECYCLED PLASTICS  
SAFETY MAINTENANCE, & IRRIGATION

**DIGITALLY PROCESSED FLAGS**

Eagle One now offers a new multi-color graphics option on all custom flags. This new digital imaging process allows us to apply logos, with multi-color shading, to all of our golf flags.

Up until now most club logos with color shading had to have colors completely separated in order to create a custom flag. With Eagle Ones new digital processing procedure, custom golf flags can have all the colors of the rainbow gradually fading into one another.

All digitally processed flags will come with our new "Soft Pocket" style of soft tube for attaching to flag poles and practice rods.

**GD700PLUS** Call For Quote



**DIGITALLY PROCESSED MILITARY FLAGS**



Our new digitally processed Military flag is a great way to honor all past and present members of the military on Memorial Day, 4th of July, Veterans Day Events or any time you would like to honor our veterans. All five branches of the military are represented. Comes in a soft pocket tube and are sold in sets of 9.

**GD700MIL9**

**FLAGS WITH BORDER**



Plain With Handle And Border  
**G760**



Screen Printed With Handle & Border  
**G780 \***



Embroidered With Handle & Border  
**G770**

\* A setup fee may apply to new customers. One Color Flags - Add cost per additional color.

PLEASE NOTE: With the purchase of 27 custom screen printed flags you will receive 9 more flags at no charge!

Flags are standard on a tube. Specify if required with grommets.



**CHECKERED FLAGS / CUT AND STITCHED CHECKS**



**G800** No Logo

With Screened Logo (1 color)  
**G890\***

With Embroidered Logo  
**G990**

\* A setup fee may apply to new customers. One Color Flags - Add cost per additional color.  
Please specify square or rectangular logo area when ordering.  
Flags are standard on a tube. Specify if required with grommets.

**AMERICAN FLAGS**



High quality durable  
American flags.  
State flags and other  
countries' flags  
available if required.

- G90012** 12" x 18" Tube Style
- G9002** 2' x 3'
- G9003** 3' x 5'
- G9004** 4' x 6'
- G9005** 5' x 8'
- G9008** 8' x 12'

**CUSTOM DESIGNS**

If you can dream it, we can make it! Any flag can be designed with your logo.  
Please call for a quote and details.



SIGNAGE

RANGE & PRACTICE

TEE AREA

FAIRWAY

GREENS

CLUBHOUSE, PRO SHOP, & TOURNAMENT

RECYCLED PLASTICS

SAFETY MAINTENANCE, & IRRIGATION

**SMUDGE BUSTER SLEEVE**



This external plastic sleeve protects the fabric wrapping the tube from dirt smudges and allows marks to be wiped clean.

**G633**  
Smudge Buster Sleeve Protector



**REPLACEMENT GROOVED FERRULE®**

**G406B**

**REFLECTIVE VINYL**

Reflective Vinyl tape for use with laser range finders.

**G400RT**



**PLACEMENT FLAGS**

Nylon cloth on plastic tube and rubber bushings. Either plain color or with a choice of statements.

Please specify flagstick diameter - 1/2" or 3/4"

Plain colors include:  
Red, White, Blue, Green, Yellow, etc.

Only the following color options are available for statements:  
(Flag/Letters) : Yellow/Black, White/Black, Red/White, Blue/White, Green/White

**G650Repair**  
"Please Repair Ball Marks"

**G650Pace**  
"Are You Keeping Pace With The Group Ahead?"

**G651**  
Plain Color Flag

**G650E**  
Customized Embroidery

**G650C**  
Customized Screen Printing  
(For one color - add cost for each additional color. A setup fee may apply.)



## QUICK RELEASE TOP STUD

- Eliminate the need to use acorn nuts on flagsticks
- Saves time when changing or removing flags
- Allows flag to easily be removed and putting on by pulling up or down on the flag tube
- Screws onto existing flagstick top stud in place of acorn nut
- Extra acorn nuts are no longer necessary
- Comes in a package of 10

PAR1740-10

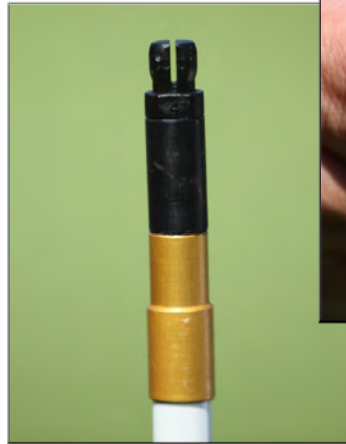

## PINSITE REFLECTOR

Convert any existing flagstick to give precise readings to laser distance measuring devices. Screws in place of top stud. Nylon thread prevents seizing to the top of the flagstick.

PAR1736



## LASER REFLECTOR

- Screws easily onto the tip of existing flagsticks in place of the acorn nut.
- Five prism reflectors are oriented to provide 360 degree reflectivity.
- Molded from DuPont Zytel ST-801 nylon for the ultimate in durability and virtually invisible to everything other than lasers.
- Make sure to use anti-seize lubricant before installing on your flagsticks.

ST26600 Laser Reflector



SIGNAGE

RANGE &  
PRACTICE

TEE AREA

FAIRWAY

GREENS

CLUBHOUSE,  
PRO SHOP, &  
TOURNAMENT

RECYCLED  
PLASTICS

SAFETY,  
MAINTENANCE,  
& IRRIGATION

SIGNAGE

RANGE & PRACTICE

TEE AREA

FAIRWAY

GREENS

CLUBHOUSE, PRO SHOP, & TOURNAMENT

RECYCLED PLASTICS

SAFETY MAINTENANCE, & IRRIGATION

**REGULAR FLAGSTICKS**

- |                     |   |                     |  |
|---------------------|---|---------------------|--|
| <b>G414B75</b>      | 71/2' Blue                                      | <b>G414T2YBLK75</b> | 71/2' With One 30"/One 12" Stripe - Yellow/Black |
| <b>G414BLK75</b>    | 71/2' Black                                     | <b>G414TBLKW75</b>  | 71/2' With 30" Stripe - Black/White              |
| <b>G414WBLK75</b>   | 71/2' White & Black                             | <b>G414TRW75</b>    | 71/2' With 30" Stripe - Red/White                |
| <b>G414BW75</b>     | 71/2' Blue & White                              | <b>G414TYBLK75</b>  | 71/2' With 30" Stripe - Yellow/Black             |
| <b>G414GW75</b>     | 71/2' Green & White                             | <b>G414W75</b>      | 71/2' White                                      |
| <b>G414R75</b>      | 71/2' Red                                       | <b>G414Y75</b>      | 71/2' Yellow                                     |
| <b>G414RW75</b>     | 71/2' Red & White                               | <b>G414YBLK75</b>   | 71/2' Yellow & Black                             |
| <b>G414T2BLKW75</b> | 71/2' With One 30"/One 12" Stripe - Black/White | <b>G414YG75</b>     | 71/2' Yellow & Green                             |
| <b>G414T2GW75</b>   | 71/2' With One 30"/One 12" Stripe - Green/White | <b>G437Y</b>        | 10' Yellow                                       |
| <b>G414T2RW75</b>   | 71/2' With One 30"/One 12" Stripe - Red/White   | <b>G437W</b>        | 10' White  |



Ferrule is grooved for easy release and non sticking.

**TOURNAMENT FLAGSTICKS**



- |                     |  |
|---------------------|--|
| <b>G400BLKW75</b>   | 71/2' Black & White                                  |
| <b>G400GW75</b>     | 71/2' Green & White                                  |
| <b>G400RW75</b>     | 71/2' Red & White                                    |
| <b>G400T2BLK75</b>  | 71/2' One 30" Bottom / One 12" Stripe - Black/White  |
| <b>G400T2RW75</b>   | 71/2' One 30" Bottom / One 12" Stripe - Red/White    |
| <b>G400T2YBLK75</b> | 71/2' One 30" Bottom / One 12" Stripe - Yellow/Black |
| <b>G400TBW75</b>    | 71/2' With 30" Stripe - Black/White                  |
| <b>G400TRW75</b>    | 71/2' With 30" Stripe - Red/White                    |
| <b>G400TYBLK75</b>  | 71/2' With 30" Stripe - Yellow/Black                 |
| <b>G400W75</b>      | 71/2' White  |
| <b>G400Y75</b>      | 71/2' Yellow   |
| <b>G400YBLK75</b>   | 71/2' Yellow & Black                                 |
| <b>G400YW75</b>     | 71/2' Yellow & White                                 |

Ferrule is grooved for easy release and non sticking.



## ROYALINE™ 1/2" FLAGSTICKS

High quality solid fiberglass with color impregnated throughout. Standard pole is 1/2" diameter and available in a combination of colors. Acorn nut is plastic.

5'			7 1/2'		
<b>ST26915</b>	White/Red Stripe		<b>ST26120</b>	Red	
<b>ST26995</b>	White		<b>ST26121</b>	Red/White Stripe	
7 1/2'			<b>ST26130</b>	Black	
<b>ST26100</b>	White		<b>ST26131</b>	Black/30" White Bottom	
<b>ST26101</b>	White/Red Stripe		<b>ST26132</b>	Black/30" Yellow Bottom	
<b>ST26102</b>	White/Blue & Red Stripe		<b>ST26140</b>	Optic Yellow	
<b>ST26103</b>	White/Black & British Stripe		10'		
<b>ST26104</b>	White/Blue Stripe		<b>ST26910</b>	White/Red Stripe	
<b>ST26105</b>	White/Green Stripe		<b>ST26911</b>	Yellow/Black Stripe	
<b>ST26110</b>	Yellow		<b>ST26980</b>	Yellow	
<b>ST26111</b>	Yellow/Black Stripe		<b>ST26990</b>	White	
<b>ST26112</b>	Yellow/30" Black Bottom			(Requires LTL shipping. Added freight charges will apply.)	



All Standard Golf flagsticks come with a Smart-Fit ferrule.



## TOURNAMENT FLAGSTICKS

Solid fiberglass sticks are 3/4" diameter tapering to 1/2" diameter at each end, giving greater stiffness for strong wind areas. Acorn nut is plastic. 71/2' long.

<b>ST26300</b>	White
<b>ST26301</b>	White/Black British Stripe
<b>ST26302</b>	White/Red British Stripe
<b>ST26303</b>	White/Green British Stripe
<b>ST26310</b>	Yellow
<b>ST26311</b>	Yellow/Black British Stripe
<b>ST26314</b>	Yellow/30" black Bottom

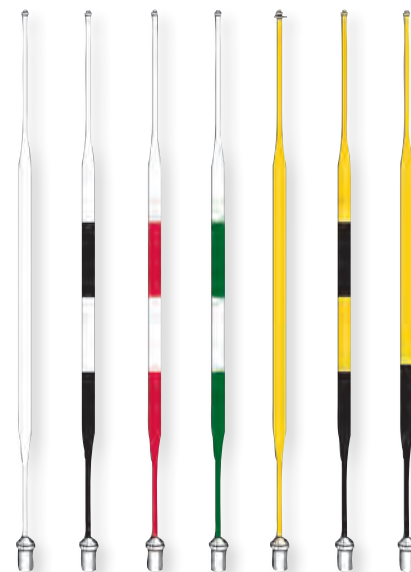

SIGNAGE

RANGE &  
PRACTICE

TEE AREA

FAIRWAY

GREENS

CLUBHOUSE,  
PRO SHOP, &  
TOURNAMENT

RECYCLED  
PLASTICS

SAFETY,  
MAINTENANCE,  
& IRRIGATION

SIGNAGE  
RANGE & PRACTICE  
TEE AREA  
FAIRWAY  
GREENS  
CLUBHOUSE, PRO SHOP, & TOURNAMENT  
RECYCLED PLASTICS  
SAFETY MAINTENANCE, & IRRIGATION



**PRISM FLAGSTICKS**

1/2 in. Fiberglass Flagsticks — 7 ft. Tall  
Boxes of 9 — Best Value  
**730-079-1** Bright White  
**740-079-1** Bright Yellow

**750-079-1** 3 Stripe Black & White

**745-079-1** Bright Yellow with 30 in. Black Bottom

1/2 in. Fiberglass Flagsticks — 8 ft. Tall  
**730-089-1** Bright White  
**740-089-1** Bright Yellow

**750-089-1** 3 Stripe Black & White

**745-089-1** Bright Yellow with 30 in. Black Bottom

3/4 in. Tapered Fiberglass Tournament Flagsticks — 7 ft., 6 in. Tall  
**706-079-1** Bright White  
**707-079-1** Bright Yellow

**708-079-1** British Stripe Black & White

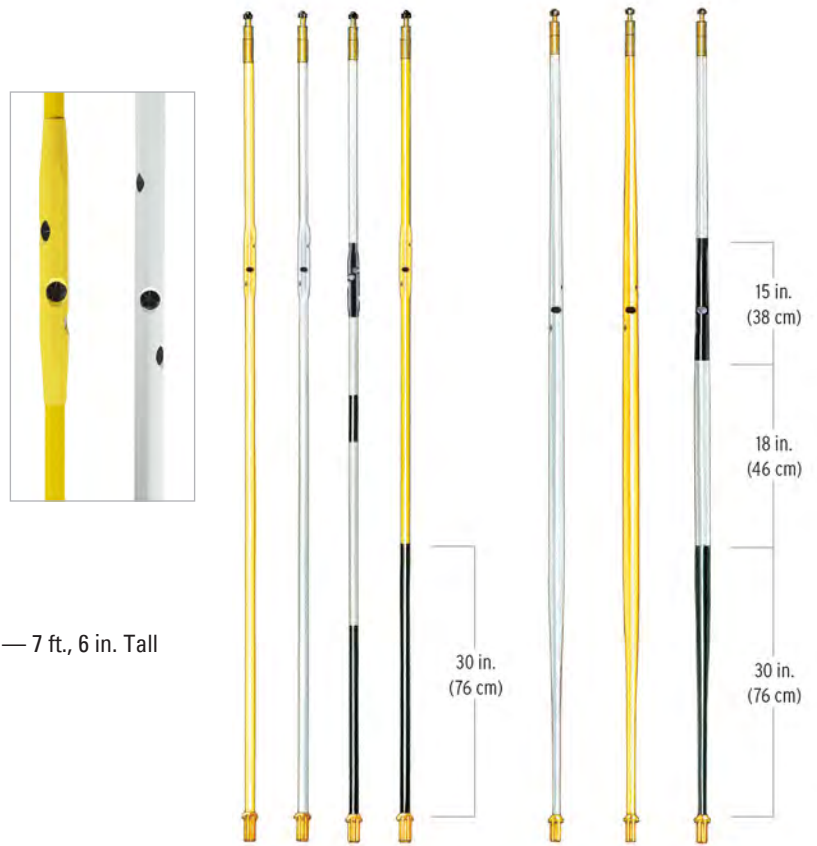

**FIBERGLASS FLAGSTICKS**

**SOLID REGULATION FIBERGLASS FLAGSTICKS**  
1/2 IN. (1 CM)

7 ft. (2.1 m) Tall  
Boxes of 9 — Best Value  
**PAR730-079** Bright White  
**PAR740-079** Bright Yellow

8 ft. (2.4 m) Tall  
**PAR730-089** Bright White  
**PAR740-089** Bright Yellow

**STRIPED REGULATION FIBERGLASS FLAGSTICKS**  
1/2 IN. (1 CM)

5 ft. (1.5 m) Tall  
Boxes of 9 — Best Value  
**PAR720-059** Red & White

7 ft. (2.1 m) Tall  
**PAR725-079** 2 Stripe Red & White  
**PAR752-079** 2 Stripe Black & White  
**PAR747-079** 2 Stripe Black & Yellow  
**PAR720-079** 3 Stripe Red & White  
**PAR750-079** 3 Stripe Black & White  
**PAR755-079** 3 Stripe Green & White

**PAR745-079** Bright Yellow with 30 in. (76 cm) Black Bottom  
**PAR754-079** Bright White with 30 in. (76 cm) Black Bottom

8 ft. (2.4 m) Tall  
**PAR725-089** 2 Stripe Red & White  
**PAR752-089** 2 Stripe Black & White  
**PAR747-089** 2 Stripe Black & Yellow  
**PAR720-089** 3 Stripe Red & White  
**PAR750-089** 3 Stripe Black & White  
**PAR755-089** 3 Stripe Green & White

**PAR745-089** Bright Yellow with 30 in. (76 cm) Black Bottom  
**PAR754-089** Bright White with 30 in. (76 cm) Black Bottom

Flagsticks are available in 10 ft. (3.1 m) and 12 ft. (3.7 m) tall. Special shipping required. Contact Par Aide for available models.

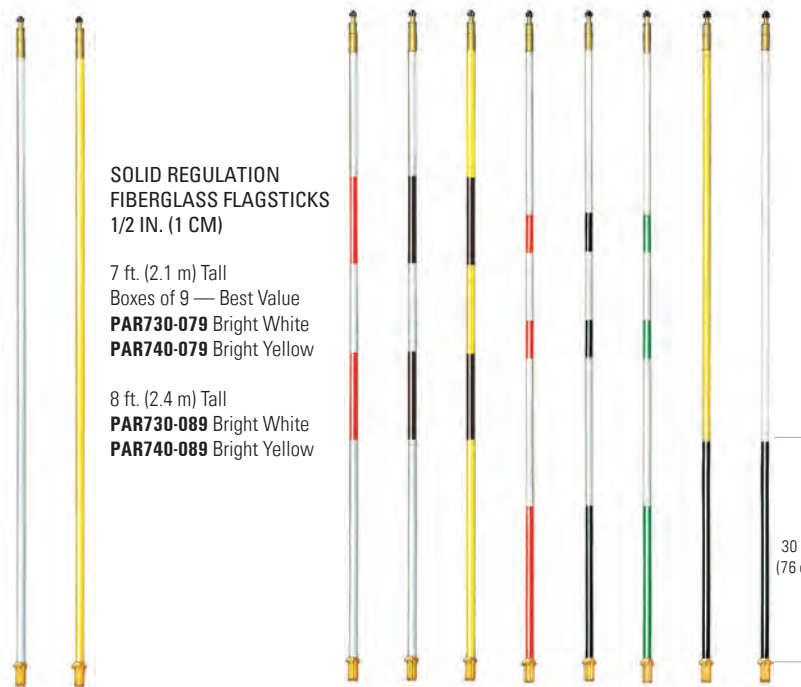



## TAPERED TOURNAMENT FLAGSTICKS

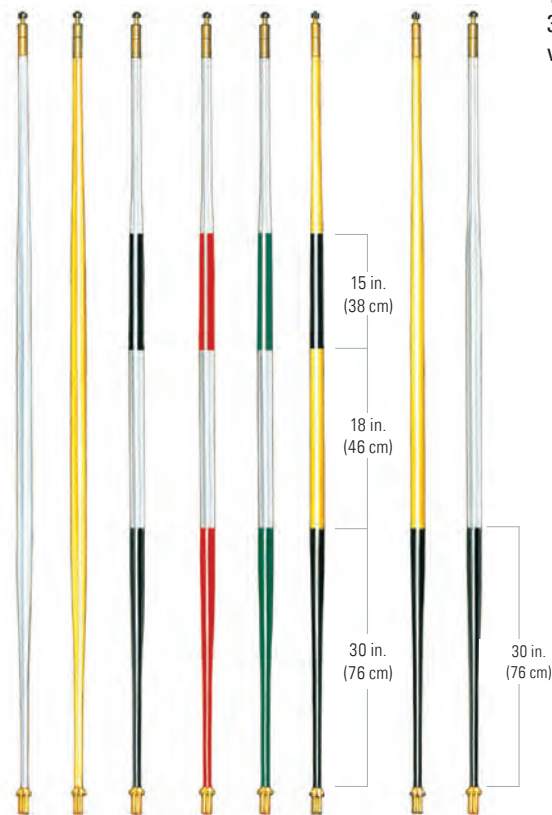

Tapered Tournament Flagsticks measure 7 ft. 6 in. (2.3 m) high and taper from a 3/4 in. (2 cm) diameter in the middle to 1/2 in. (1 cm) at the ends. They're more visible and offer a solid and sturdy look and feel.

7 ft. 6 in. (2.3 m) Tall  
Boxes of 9 — Best Value  
**PAR706-079** Bright White  
**PAR707-079** Bright Yellow

**PAR708-079**  
British Stripe Black & White  
**PAR712-079**  
British Stripe Red & White  
**PAR713-079**  
British Stripe Green & White  
**PAR714-079**  
British Stripe Black & Yellow

**PAR709-079**  
Bright Yellow with 30 in. (76 cm)  
Black Bottom  
**PAR711-079**  
Bright White with 30 in. (76 cm)  
Black Bottom

**PAR1715** Swivel for Tie-Style Flags  
**PAR1729-6** Patented Ferrule  
Package of 6  
**PAR1732-6** Top Stud  
Package of 6  
**PAR1733-6** Acorn Nut  
Package of 6



## ALUMINUM TOURNAMENT FLAGSTICKS

1 in. (3 CM) Aluminum/Fiberglass Tournament Flagsticks  
A full 8 ft. (2.4 m) tall, this lightweight exclusive Par Aide design meets USGA regulations.

- Ultimate visibility.
- Top and bottom shanks are 1/2 in. (1 cm) diameter, color-impregnated fiberglass in Bright Yellow, Bright White, or Black.
- Flagstick body is 1 in. (3 cm) diameter aluminum.
- Powder-coated body allows for a completely custom look. Colors and patterns can be changed to accommodate your course needs.

8 ft. (2.4 m) Tall  
Boxes of 9 — Best Value  
**PAR701-089** Bright Yellow  
**PAR702-089** Bright White  
**PAR703-089** One Black Stripe  
**PAR704-089** Two Black Stripes  
**PAR705-089** Three Black Stripes

**PAR703-99** One Custom Stripe\*  
**PAR704-99** Two Custom Stripes\*  
**PAR705-99** Three Custom Stripes\*

\*For all other colors/combinations, please clearly indicate color(s) and patterns when ordering.

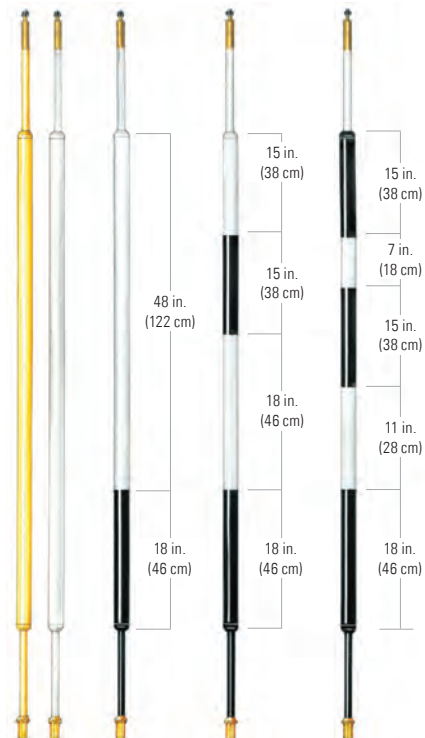

SIGNAGE

RANGE &  
PRACTICE

TEE AREA

FAIRWAY

GREENS

CLUBHOUSE,  
PRO SHOP, &  
TOURNAMENT

RECYCLED  
PLASTICS

SAFETY,  
MAINTENANCE,  
& IRRIGATION

SIGNAGE  
RANGE & PRACTICE  
TEE AREA  
FAIRWAY  
GREENS  
CLUBHOUSE, PRO SHOP, & TOURNAMENT  
RECYCLED PLASTICS  
SAFETY MAINTENANCE, & IRRIGATION



Generate new revenue with no additional maintenance costs and an amazing 30-60 day ROI, with the fastest growing sport in the United States - FootGolf!

Why is FootGolf so appealing for courses and players alike?

- Inexpensive for clients and the course.
- Pace of Play – Takes about an hour to play 9 holes.
- Attracts new clients from a large demographic.
- Ability Friendly – All ages & skill levels can play.
- Community Activity – Additional recreation activity.
- Fitness – Walking 9 holes is approximately 2 miles.
- Competitive – All ages can compete against one another.
- Additional cart and concession revenue.

**GFG150** FootGolf Cup  
**GFG151** Ball Elevator



Premier FootGolf Official Cup Specifications:

- 21" interior diameter x 12" depth.
- Cup's outer 1" lip features a 10 degree downward slant to better allow the ball to drop in the cup.
- Bottom of cup & elevator is designed to allow for great water drainage.

**The Premier FootGolf Official Ball Elevator**

The Ball Elevator is designed for ease of removing the ball from the cup. Simply lift up the flag stick and the ball elevator disk lifts the ball out. No need for bending over to retrieve the ball, making FootGolf ideal for all ages.

- Made of durable polypropylene.
- Manufactured in the United States.
- Attractive Augusta Green.







## 15" COLOSSAL CUP

Let's make golf fun again!



Attract new golfers at your course! 15" holes provide an alternative way for kids, beginners, and those who play the sport in a more casual way, to enjoy the game of golf. 15" holes not only make golf more fun, but also will help speed up pace of play!

- |               |                 |
|---------------|-----------------|
| <b>G115C</b>  | 15" Cup         |
| <b>G115HC</b> | 15" Hole Cutter |
| <b>G115FS</b> | 5' Flagstick    |
| <b>G115F</b>  | 15" Flag        |
| <b>G115TM</b> | 15" Tee Marker  |

How do we make the game more Fun?

- Easier to play
- Faster rounds
- Lower scores
- Create kid's, senior's, family events



## 8" SPECIAL EVENT CUP



- Powder-coated 8" w (20.3 cm) x 3" h (8 cm) steel cup
- Also available in plastic
- Fits standard-sized flagsticks
- Great addition for "big hole" events
- Shorter-depth 8" cup is easily installed with the 8" Pro II Hole Cutter

- |                 |                      |
|-----------------|----------------------|
| <b>ST18700</b>  | 8" White Steel Cup   |
| <b>ST18700P</b> | 8" Pink Steel Cup    |
| <b>ST18775</b>  | 8" White Plastic Cup |
| <b>ST18775P</b> | 8" Pink Plastic Cup  |

SIGNAGE

RANGE &  
PRACTICE

TEE AREA

FAIRWAY

GREENS

CLUBHOUSE,  
PRO SHOP, &  
TOURNAMENT

RECYCLED  
PLASTICS

SAFETY,  
MAINTENANCE,  
& IRRIGATION

**ALUMINUM CUP**



Cast from aluminum this cup is anodized and then powder coated white except for the internal cone area that supports the flagstick. This high wear area is dark gray in color so that it always looks good and does not require constant maintenance.

**G500** Aluminum

**GREENS CUP**



Molded from rugged polymers for resistance to chemicals. Brilliant white color for good visibility.

**G505** Plastic

**GREENS CUP ADVERTISING**



Here is another effective way for sponsors to get their name in front of customers. Using vinyl graphics we can supply either transfers for you to apply or we can supply the complete cup with graphics.

**\$530**

**FOAM CUP PLUGS**



These simple Styrofoam cup plugs work great for keeping your cups clean from sand and topdressing. Simple to use and unbreakable.

Foam Plug  
**G559**

**PLASTIC CUP COVER**



These cup covers are made from hard durable plastic.

Plastic cover  
**G558**

**CUP PULLER**



**ST33200**  
Single Prong

**STANDARD GOLF COMPANY**

SIGNAGE  
RANGE & PRACTICE  
TEE AREA  
FAIRWAY  
GREENS  
CLUBHOUSE, PRO SHOP, & TOURNAMENT  
RECYCLED PLASTICS  
SAFETY MAINTENANCE, & IRRIGATION



**SMART-FIT™ CUP AND FERRULE SYSTEM**

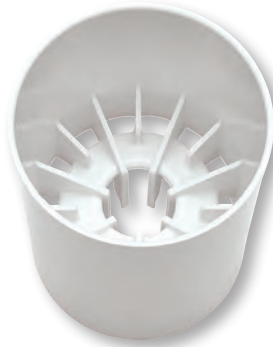

This cup is designed with fillets that support the flagstick ferrule. This allows soil or sand to pass through reducing the chance of sticking. The notched ferrule system prevents your flagsticks from 'walking' out of the cup, rotating, preventing excessive wear on the ferrule and keeps the flagsticks straight.

- ST18222** Plastic Cup
- ST18333** Aluminum Cup
- ST26515** Replacement Smart-Fit™ Ferrule



**PUTTING CUPS**

6in. putting cup meets all USGA regulations.

**PAR920**  
Plastic Cup  
(shown)

**PAR930**  
Aluminum Cup



**RIJI CUP**

This cup is molded from rugged polymers for resistance to chemicals. Tapered sides allow easy removal.

- ST18200** Riji Cup (shown)
- ST18303** Aluminum Cup



**EVER WHITE CUP**

The patented Ever-White Cup has revolutionized the putting cup by teaming an aluminum outside with a Bright White plastic sleeve.

- paint to chip, eliminating the need for stripping, sanding and painting.
- Easily replaceable sleeve stays tight in the cup during play.
- Resonates with the classic aluminum sound when the ball drops in.

- PAR935** Ever White Cup
- PAR935-1** Replacement Liner - White  
Sold in sets of 18
- PAR930-99** Pink Cup
- PAR935-4** Replacement Liner - Pink  
Sold in sets of 18



Pink Replacement Sleeve



**CUSTOM DECAL**

Celebrate special events with this surprising extra touch. Minimum order 36 decals, only one logo is included in the minimum order. No art charge when vector art is supplied. Sleeves and decals sold separately. Customer applies decal.  
**PAR520-1**

SIGNAGE

RANGE &  
PRACTICE

TEE AREA

FAIRWAY

GREENS

CLUBHOUSE,  
PRO SHOP, &  
TOURNAMENT

RECYCLED  
PLASTICS

SAFETY,  
MAINTENANCE,  
& IRRIGATION

SIGNAGE  
RANGE & PRACTICE  
TEE AREA  
FAIRWAY  
GREENS  
CLUBHOUSE, PRO SHOP, & TOURNAMENT  
RECYCLED PLASTICS  
SAFETY MAINTENANCE, & IRRIGATION



**PAR AIDE HIO HOLE CUTTER**

**THE ART OF HOLE CUTTING TAKEN UP A NOTCH**

The best pound-in hole cutter with its precision, ease-of-use and time- and body-saving ability. To operate, simply pull out the pin, lift the handle, and the hammer action drives it into the ground.

Enjoy the following advantages:

- Perfectly round holes with clean edges.
- Easy on arms and shoulders — no twisting required.
- Easy for any crew member to operate.
- Powerful action works great on clay-based “push up” greens.
- Achieve uniform hole depth.
- Saves time.
- Perfect for Bermuda greens, as grain direction is easily matched when replacing plugs

- PAR1003-1** HiO Hole Cutter with inside sharpened blade — sand-based, USGA greens
- PAR1003-2** HiO Hole Cutter with outside sharpened blade — native soil “push up” greens

- PAR1009-01** HiO inside sharpened replacement blade — sand-based, USGA greens
- PAR1009-02** HiO outside sharpened replacement blade — native soil “push up” greens



**1 TWO-PIECE STEEL HANDLE**  
**PAR1003-21**  
(hardware and grips included)

**2 RUBBER GRIP**  
**PAR1003-9**  
(pair)

**3 LOCKING PIN, SPRING & BALL KIT**  
**PAR1003-22**

**4 OUTER TUBE**  
**PAR1003-7**  
(complete)

**5 EJECTING ROD**  
**PAR1003-10**  
(complete)

**6 EJECTING HANDLE**  
**PAR1003-8**  
(complete)

**7 CLEAT**  
**PAR1003-16**

**8 ROPE**  
**PAR1003-17**

**9 RUBBER RING**  
**PAR1003-13**

**10 DEPTH GAUGE**  
Unique single set screw design allows for easy locating, straightening and tightening. Cast aluminum and anodized Black, fits all hole cutters.  
**PAR1034**

**11 HIO™ BUBBLE LEVEL**  
This optional item for the HiO Hole Cutter assures a straight cup every time. It fits all existing HiO Hole Cutters, simply attaching through the two bolts that hold the handle in place.  
**PAR1028**

**12 TRIANGLE PLATE**  
**PAR1003-26**  
(not shown)

**13 INNER TUBE**  
**PAR1003-25**  
(complete) (not shown)

**14 PISTON**  
**PAR1017**  
(complete) (not shown)

**15 STOP RING & PIN KIT**  
**PAR1003-23**  
(not shown)



**HOLE CUTTER BLADE SHARPENER**

This unit quickly puts a razor sharp edge on your hole cutter blade. Blade is simply put into sharpener and rotated slightly, with a light touch you get a microscopic honing. Sharp blade will help prevent root damage. Unit works on 3-scallop, 4-scallop or straight edge cutters by simply changing the sharpener disk. Twelve month warranty!

- E250** Hole Cutter Sharpener
- E2503** 3.5" Disc (Par Aide, R&R, Bayco)
- E2504** 4.0" Disc (Standard)

### ORIGINAL LEVER ACTION HOLE CUTTER

A back-saving  
design that  
allows for easier  
plug extraction.



- PAR1001-1 With Scalloped Blade, Inside Edge
- PAR1001-2 With Scalloped Blade, Outside Edge
- PAR1001-3 With Straight Blade, Inside Edge
- PAR1001-4 With Straight Blade, Outside Edge

- PAR1001-19 With Scalloped Blade,  
Inside Edge and Bubble Level
- PAR1001-29 With Scalloped Blade,  
Outside Edge and Bubble Level
- PAR1001-39 With Straight Blade,  
Inside Edge and Bubble Level
- PAR1001-49 With Straight Blade,  
Outside Edge and Bubble Level

### ORIGINAL FOOT EXTRACTION HOLE CUTTER

Turf plug is  
extracted by  
stepping down  
on foot plate.



- PAR1002-1 With Scalloped Blade, Inside Edge
- PAR1002-2 With Scalloped Blade, Outside Edge
- PAR1002-3 With Straight Blade, Inside Edge
- PAR1002-4 With Straight Blade, Outside Edge

- PAR1002-19 With Scalloped Blade,  
Inside Edge and Bubble Level
- PAR1002-29 With Scalloped Blade,  
Outside Edge and Bubble Level
- PAR1002-39 With Straight Blade,  
Inside Edge and Bubble Level
- PAR1002-49 With Straight Blade,  
Outside Edge and Bubble Level

### HOLE CUTTER BLADES



Our redesigned, 1/2 in. longer, hole cutter blade allows you to cut and set your cup deeper. USGA rules state that a cup must be set a minimum of 1 in. below the surface of the green.

- Hole Cutter Blade,  
7-1/2 in. (18 cm) Plain  
PAR1007-01 Inside Sharpened Edge  
PAR1007-02 Outside Sharpened Edge



- Hole Cutter Blade,  
7-1/2 in. (18 cm) Scalloped  
PAR1008-01 Inside Sharpened Edge  
PAR1008-02 Outside Sharpened Edge



### DEPTH GAUGE



Unique single set screw design allows for easy locating, straightening and tightening. Cast aluminum and anodized Black, fits all hole cutters.

PAR1034

### HOLE CUTTER SHARPENER



For clean, sharp hole edges in your green, give your hole cutter shell a few passes everyday with this handy tool. Keeps scalloped or straight cutter shells sharp. Sharpens shell edge inside or outside. Easy to use and very economical.

ST28400



SIGNAGE

RANGE &  
PRACTICE

TEE AREA

FAIRWAY

GREENS

CLUBHOUSE,  
PRO SHOP, &  
TOURNAMENT

RECYCLED  
PLASTICS

SAFETY,  
MAINTENANCE,  
& IRRIGATION

SIGNAGE  
RANGE & PRACTICE  
TEE AREA  
FAIRWAY  
GREENS  
CLUBHOUSE, PRO SHOP, & TOURNAMENT  
RECYCLED PLASTICS  
SAFETY MAINTENANCE, & IRRIGATION



**HOLE CUTTER GUIDE**

Fabricated from durable plastic, this guide ensures a true cup hole and protects the surrounding green while extracting the hole cutter.

**G030L**



**ALUMINUM CUP SETTER**

Seats cup to correct depth and flattens down cup hole edges.

**G003**



**TARGET RINGS**

These bright white plastic rings slip on top of greens cups to highlight the area above the cup. Easy insertion and removal.

**G005** 1 Ring  
**G00518** Set of 18



**HOLE GROOMER**

Whether you change your cup position daily or not the "Hole Groomer" is a must. This unique tool creates an edge to the cup hole so crisp and clean that you won't believe how it adds to the professional look of your course. Only taking a few short seconds, the groomer works by fitting the round blade inside the cup hole (with or without the cup in the hole). Several quick squeezes on the handle and then rotate through 90 degrees and repeat. Remove to reveal the trimmed hole.

**G515**

**PRO II HOLE CUTTER**

- Simple, economical and ready to cut.
- Hot-rolled tubing. Carbon steel shaft.
- Adjustable depth collar. Foot ejector.

**ST28700** 4.5" Straight Shell Inside  
**ST28800** 4.5" Scalloped Shell Inside  
**ST28801** 4.5" Scalloped Shell Outside  
**ST28775** 6" Straight Shell Inside  
**ST28785** 8" Straight Shell Inside



Please call for replacement shells.

**STANDARD GOLF COMPANY**

**PRECISION HOLE CUTTER**

This is the professionals hole cutter. The features include utilizing a built in slide hammer (with noise damper) for easy and accurate cutting, built in level on the handle for vertical cutting, two cutting depth gauges for regulation and putting cup depths making the depth right every time, quick blade change over, padded handles for comfort. The precision cutter comes complete with video showing all the features and tips for better cup cutting and has proven to reduce cup changing time by approximately 30 minutes per day on a typical eighteen hole course. Two blade choices for either sand or clay.

- G490** Hole Cutter For Sand Greens
- G490C** Hole Cutter For Clay Greens
- G490BUSH1** Nylon Bushing - 3 Pack 1"
- G490BUSH1.25** Nylon Bushing - 3 Pack 1 1/4"
- G491** Replacement Blade - Sand
- G491C** Replacement Blade - Clay
- G490H** Replacement Slide Hammer
- G490HH** Replacement Hammer Handle
- G490LEVEL** Replacement Level
- G490SHAFT** Replacement Aluminum Shaft

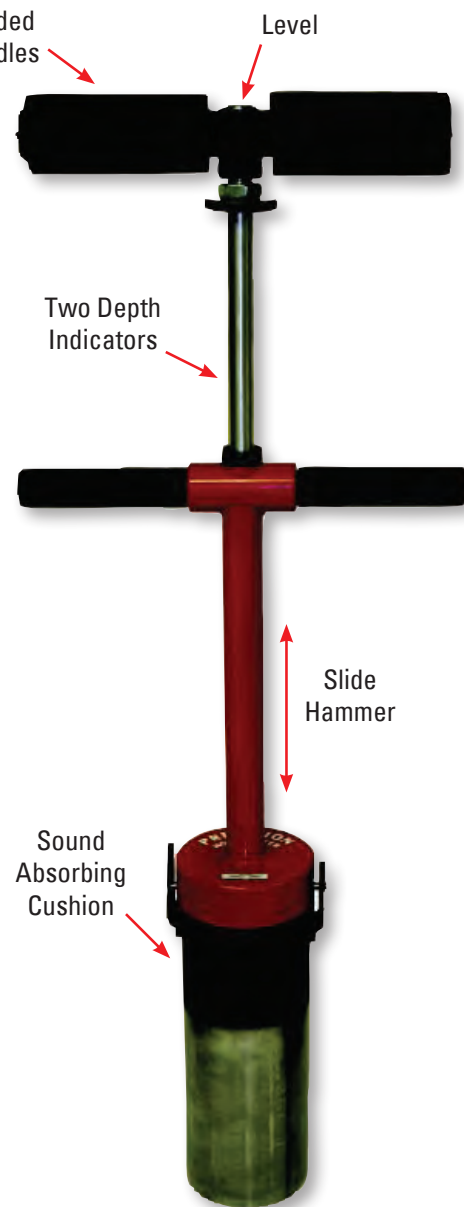

**HOLE IN WHITE**

Efficiently color the inside of the putting hole with this tool. Gimbal drops in the hole and a special spray paint can works upside down to color the hole walls. Simply press down and spin. USGA Approved.

- R250** Tool
- R251** Hole in Paint
- R251C** Case of 12 Cans

For breast cancer awareness, we have now added pink paint.

- R251P** Pink Paint
- R251PC** Case of 6 Cans

SIGNAGE  
RANGE & PRACTICE  
TEE AREA  
FAIRWAY  
GREENS  
CLUBHOUSE, PRO SHOP, & TOURNAMENT  
RECYCLED PLASTICS  
SAFETY, MAINTENANCE, & IRRIGATION



**POCKET TUBULAR 1/2" SOIL PROBE**

The Pocket Tubular Soil Sampler - 1/2 inch diameter soil sampler. This tool that is the smallest diameter tubular soil sampler in the business. Its 1/2 inch diameter sampling tube is made of Stainless Steel. The rugged but lightweight sampler is perfect for quick soil sampling of areas like golf greens without leaving behind a large hole. It will remove a clean sample to a depth of six inches in all types of soils. Quickly inspect the soil for moisture content, root depth or any other physical characteristics. In addition, the Pocket Tubular Soil Sampler - 1/2" Diameter is manufactured out of Stainless Steel so you can also use it for soil sample collection without the worry of contamination from iron, copper or zinc. Its overall length is eight and a half inches which is ideal for carrying with you anywhere.

**G009POCKET**

**TURF PROBE**

Minimize damage to turf with small diameter probe.

The turf probe is designed to collect a small 9" by 1/2" diameter soil sample from sod or grassed area. The probe slot allows easy visual inspection and cleaning. The probe is made from nickel plated carbon steel and has a built-in 7" cross handle that is welded on. The overall length of the probe is 18"

18" Plated One-Piece Turf Probe  
**G024**

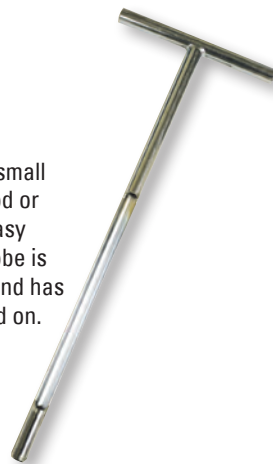

**7/8" SOIL PROBE**

- These nickel plated probes are rust-resistant.
- Sturdy design which resists bending and twisting out of shape.
- 7" cross handle.
- Clean, wide slot in the probe body for easy removal of sample.

7/8" x 21.5" Plated Soil Probe  
**G026**

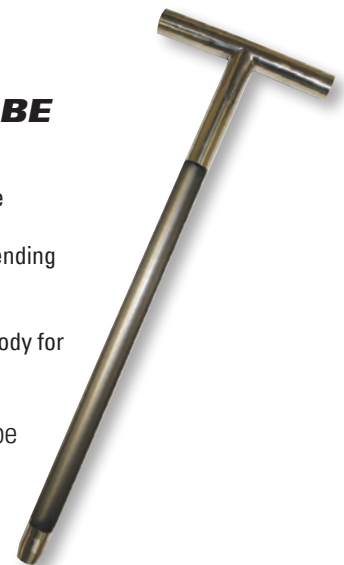

**DEW WHIP**

Three part fiberglass telescoping dew whip extends quickly to 18' for dew removal.

**G015**



**WHIPPING POLE**

Each whipping pole offers two piece design with light weight aluminum handle.

- PAR1040** Original Whipping Pole
- PAR1060** E-Z Whipping Pole



SIGNAGE  
RANGE & PRACTICE  
TEE AREA  
FAIRWAY  
GREENS  
CLUBHOUSE, PRO SHOP, & TOURNAMENT  
RECYCLED PLASTICS  
SAFETY MAINTENANCE, & IRRIGATION



**AERIFIER WITH CORE COLLECTOR**

Choose from solid or hollow tines, each with 2 ¼" penetration. If you're using hollow tines, the Hand Aerifier includes a core collector to help you clean up. Each tine base includes nine replaceable tines on 2" centers. The body assembly features rugged steel construction and a powder-coated finish.



**Specifications:**

Weight Complete with Tines: 9 lbs (4 kg)  
Tine Length: 3 x 3/8" (7.6 x 0.95 cm)  
Tine Penetration: 2 ¼" (5.7 cm)  
Tine Centers: 2" (5.08 cm)

- ST29808** Body Assembly Less Tines
- ST29803** Hollow Tines Base Assembly
- ST29805** Solid Tines Base Assembly

**Ordering:**

Order the Body Assembly and a Tine Base Assembly separately.



**SPIKED ROLLER AERIFIER**

This is a handy tool for small aerifying jobs. Sturdy plastic spikes wrap around roller frame and puncture turf as you roll, aerifying the surface.

- ST71708** 8"
- ST71716** 16"

**MAGNUM LUTE**

This is a double edged reversible blade for pushing or pulling. Ideal for aerification plugs. Handle is 66" long.

- ST71424** 24" Magnum Lute
- ST71436** 36" Magnum Lute



**ROLLER / SQUEEGEE**



Double closed cell foam rubber roller with stainless steel shaft and heavy duty bearings. Ideal for greens, tennis courts, etc.

- ST71324** 24" With 66" Aluminum Handle
- ST71336** 36" With 60" Aluminum Handle
- ST71348** 48" With 66" Aluminum Handle
- ST71325** Replacement 24" Roller For Squeegee
- ST71337** Replacement 36" Roller For Squeegee
- ST71349** Replacement 48" Roller For Squeegee

- SIGNAGE
- RANGE & PRACTICE
- TEE AREA
- FAIRWAY
- GREENS
- CLUBHOUSE, PRO SHOP, & TOURNAMENT
- RECYCLED PLASTICS
- SAFETY, MAINTENANCE, & IRRIGATION



**KLAW**

Finally a ball repair tool that really works!!! Made primarily of stainless steel this one-action device not only repairs ball marks properly it does it very fast. By pushing down on the handle, two multi prong teeth first project into the turf in a wedge format. As they go deeper the wedge width closes in and finally towards the bottom of the stroke the teeth become parallel. This intricate series of actions pulls the turf towards itself lifting it back into place. Final tamping completes the repair. The Klaw performs the most frequently recommended motion to repair ball marks. Repair speed is estimated between 15 - 20 in about two minutes. Great for weaving plugs back into green.

- G560** Klaw
- G560RK** Repair Kit

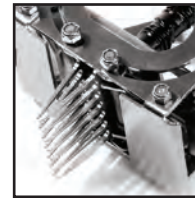

SIGNAGE

RANGE & PRACTICE

TEE AREA

FAIRWAY

GREENS

CLUBHOUSE, PRO SHOP, & TOURNAMENT

RECYCLED PLASTICS

SAFETY MAINTENANCE, & IRRIGATION

9 lb. Easy Spreader Steel Rake  
Great for golf course construction, leveling tee areas or smoothing out banking. More rugged than traditional rakes. Perfect for spreading and leveling loam for sod cutting areas.

**G018**



**EASY SPREADER**

3lb. Easy Spreader. Ergonomic and easy to use. The 3 lb. Easy Spreader is great for sand traps, top dressing or any other light to medium duty leveling. Easy push or pull.

**G017**



**LEVEL SPREADER**

Spread and smooth out soil before seeding or planting. The Level Spreader is the right tool to prepare soil on all the right projects. Features a 34" x 10" plated steel head and a sturdy 72" wooden handle.

**MIL540580**

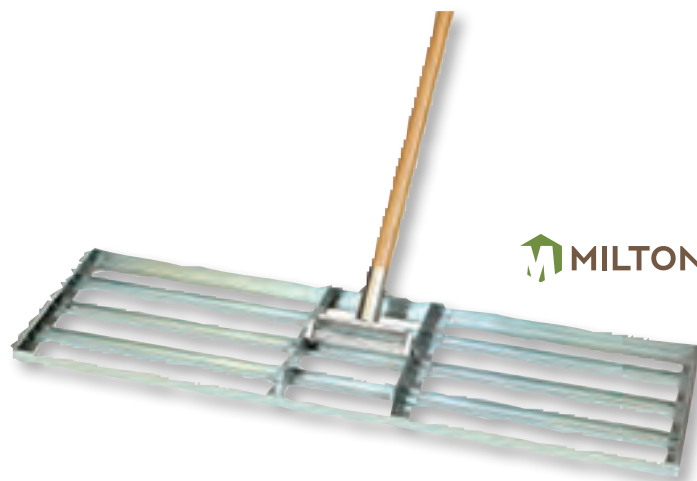

**MILTONA**

**BREAKMASTER  
GREEN SLOPE READER**

Lay this device anywhere on your green to get a precise digital reading of the slope. Will fit in the palm of your hand, includes batteries with over 1 year of life and are easily replaceable. The Breakmaster reports the direction and severity of a slope in about 1 second.



**G001SL**

**GREENS  
SPEED METER**

Extruded aluminum ramp measures the speed of the putting green. (instructions included)

**G001**



**PRISM-GAGE™**

The PRISM-GAGE™ is a right angle prism with precision measurement lines inscribed on one face of the prism. When viewing through the PRISM-GAGE™, these graduated lines are superimposed on the turf so the viewer may measure the actual height of the turfgrass and thus be able to compare it with mower bench settings. The observer may also inspect the quality of cut by comparing the turf over the viewing plane of the prism.

Lines are inscribed at .100, .200, .300, .400, .500, .750, 1.0 and 1.5 inch. The lines appear superimposed on the turf enabling the observer to determine actual height of cut. By slightly tilting the prism, a larger over view of the turf may be viewed in order to observe the "quality" of cut.

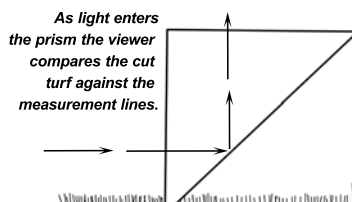

**G100** Prism-Gage™

**G100M** Prism-Gage™ (metric)



**DRAG BRUSH**

This brush drags behind your work vehicle and gently and evenly works top dressing into the green. Basic unit is 54 1/2" wide, two 27" wide extensions can be added to increase total width if desired. Each unit comes with weight racks to reduce vibration and follow undulations.

- ST52000** Drag Brush
- ST52050** Set Of Two Extensions
- ST52013** 54" Replacement Drag Brush
- ST52063** 27" Replacement Extension Brush



SIGNAGE

RANGE &  
PRACTICE

TEE AREA

FAIRWAY

GREENS

CLUBHOUSE,  
PRO SHOP, &  
TOURNAMENT

RECYCLED  
PLASTICS

SAFETY,  
MAINTENANCE,  
& IRRIGATION

SIGNAGE

RANGE & PRACTICE

TEE AREA

FAIRWAY

GREENS

CLUBHOUSE, PRO SHOP, & TOURNAMENT

RECYCLED PLASTICS

SAFETY MAINTENANCE, & IRRIGATION

**COCOA DRAG MATS**



This mat offers the ultimate in protection for your tender turf while top dressing and filling the aerated holes. Made from natural cocoa fibers and bound by a thick plastic backing this mat can be used in multi-seasons. Towing harness can be hitched to a cart, mower or any prime mover. Standard sizes are 4'x6', 5'x6' and 6'x6' with 5' towing harness. Custom sizes are available upon request.

- G07046** 4'x 6' Drag Mat
- G07056** 5'x 6' Drag Mat
- G07066** 6'x 6' Drag Mat

- G070BAR4** Replacement Bar Assembly 4'
- G070BAR5** Replacement Bar Assembly 5'
- G070BAR6** Replacement Bar Assembly 6'

**FLEXIBLE DRAG MAT**

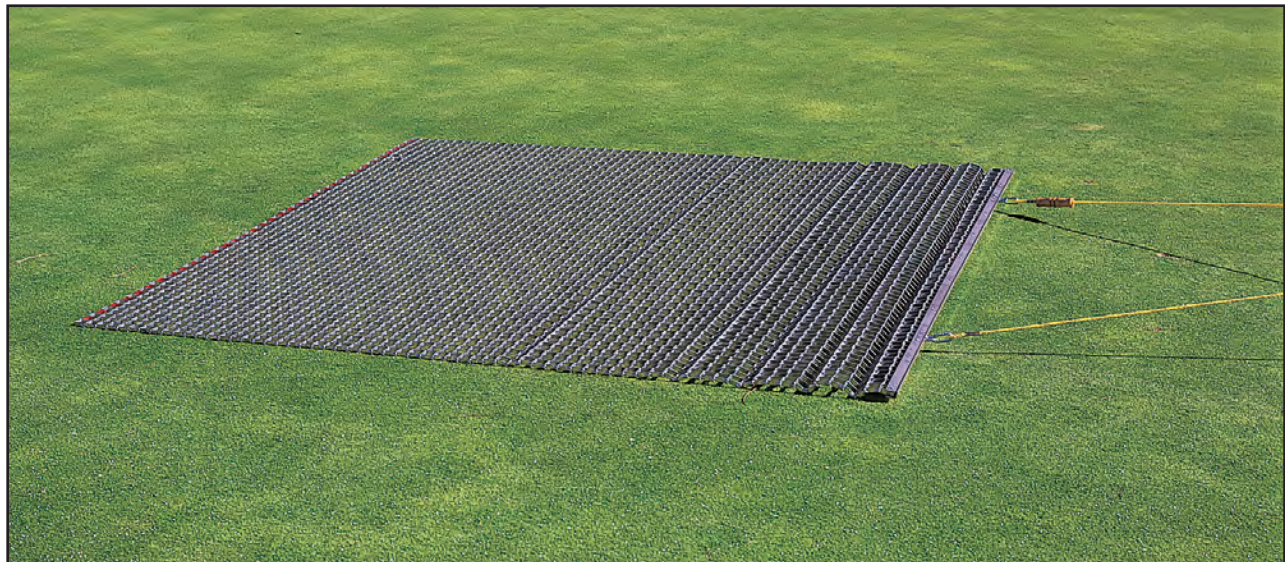

Galvanized steel mats are ideal for spreading sand and seed mix on your greens. Open mesh flexes to allow even distribution of sand and rolling up for storage. Custom sizes also available.

- G01036** 36" X 60"
- G01048** 40" X 84"
- G01066** 60" X 60"
- G01068** 60" X 84"
- G01077** 72" X 72"
- G01078** 72" X 84"

**POLY EXTRUDED MATTING**

This textured P.V.C. surface provides sure footing - reducing the risk of slipping on bridges, steps and walkways. The material allows moisture to flow through, trims easily with a razor knife and is light weight. It can be adhered to concrete, wood, asphalt or steel with GE 2801 silicone or simply screwed down. Poly extruded matting is easy to clean by sweeping or washing down and can withstand temperature ranges of -35 Degrees to + 180 Degrees F. It resists alkalis, acids, ozone and water borne chemicals.

Stock colors are Hunter Green and Black. Other colors are available, but a longer lead time is required when ordering any of the following colors: Chocolate Brown, Sandstone or Gray.

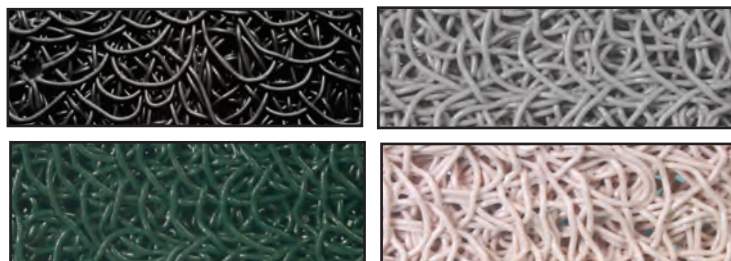

Excellent adhesives are available for securing your PEM matting to concrete, wood, asphalt or steel.

- C131G** GE 1800 Silicone, 10.1 oz, Tube
- C131SA** Pro Fix 240 Seam Adhesive, 1lb. Bottle
- C131SAA** Pro Fix 241 Seam Adhesive Accelerator, 6oz. Can

- C1313G** PVC Matting 3'X 25' Roll Green
- C1316G** PVC Matting 6'X 25' Roll Green
- C1313BLK** PVC Matting 3'X 25' Roll Black
- C1316BLK** PVC Matting 6'X 25' Roll Black
- C1313CB** PVC Matting 3'X 25' Roll Chocolate Brown
- C1316CB** PVC Matting 6'X 25' Roll Chocolate Brown
- C1313S** PVC Matting 3'X 25' Roll Sandstone
- C1316S** PVC Matting 6'X 25' Roll Sandstone
- C1313GY** PVC Matting 3'X 25' Roll Gray
- C1316GY** PVC Matting 6'X 25' Roll Gray
- C131BS** PVC Seam Backing Strip, 100ft. Roll

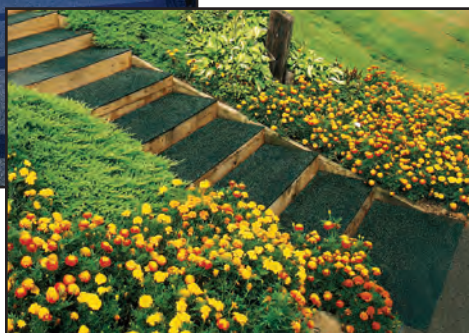
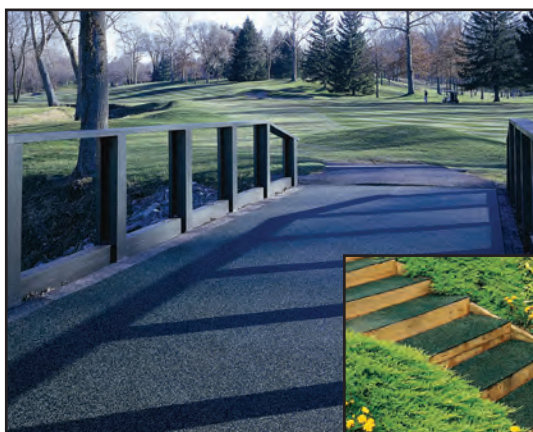

**RECYCLED ROLL RUBBER MATTING**

Manufactured by the largest Recycler of car and truck tires in North America. Provides non slip surface for all types of bridges, stairs and walkways. Can be loose laid for temporary applications or glued down with Eco Grip Adhesive. 3/8" thick x 4' wide rolls. Available in 25' and 50' lengths. Standard color is black with green specks. Custom colors available.

- C15025G** 4' x 25' Roll
- C15050G** 4' x 50' Roll



SIGNAGE

RANGE & PRACTICE

TEE AREA

FAIRWAY

GREENS

CLUBHOUSE, PRO SHOP, & TOURNAMENT

RECYCLED PLASTICS

SAFETY MAINTENANCE, & IRRIGATION



## NEET-KLEET II ELECTRIC SHOE CLEANER

Available in Hunter Green,  
Desert Stone, Gray Granite



- Eliminates unsightly paint chipping, fading and rusting!
- Dual handles provide a stable platform while cleaning golf shoes.
- Push button in handle activates machine from 110 outlet.
- All debris is captured in the removable grass receptacle for daily maintenance.
- Rotating nylon brushes clean sides, soles, heels and toes.
- Nylon Brush suitable for steel or alternative spikes.
- Weight: 50 lbs.
- Size: 32" L x 15½" W x 32" H

**WGL70**

\*\*Also available in 220V units for no extra charge.

## COMPRESSED AIR SPIKE CLEANER



This console offers convenient spike cleaning while keeping your facility neat and clean. Made from durable GreenWood™ it is made to be used with compressed air to clean the bottom of the golfer's spike shoes. The Double unit allows two people to clean their cleats at one time. Clippings are contained by the high wrap around walls and a 90 degree wand allows easy low body reach cleaning action. Contained clippings fall through a bottom grate into a removable tray for easy disposal. Each unit comes with Deluxe 20" Long Air Blow Gun. CUSTOM LOGO'S ARE EXTRA.

**C055NE**  
Single  
Cleaner



**C055DBLNE** Double Cleaner



**C055COMP**



**C055ABG20**  
Deluxe 20" Long  
Air Blow Gun



**C055ABG**  
Air Blow Gun Kit



**C055BC**  
Air Quick Coupler Set

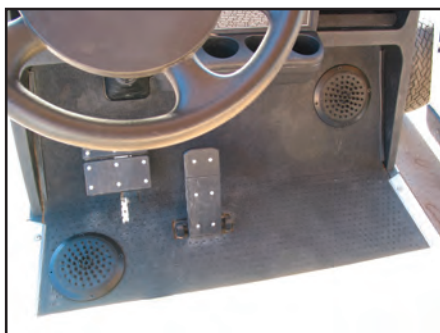

**"SOFTSWIPE" SPIKE CLEANER**



Rubber prongs mounted onto an aluminum base allow efficient cleaning of golf cleats. Either cart mounted or used with ground anchors at Tee boxes etc.

- C005** Ground Mounted
- C005C** Cart Mounted per pair
- C005R** Replacement Top

**GREENWOOD™ SPIKE BRUSH**

This spike brush will always look good. It is made from low maintenance GreenWood™ and can either bolt down to solid surfaces or spike down into grass.

**C011**



**SPIKE BRUSHES**



- No Side Brushes, Bolt Down **C006**
- No Side Brushes, Spike Down **C006S**
- With Side Brushes, Bolt Down **C007**
- With Side Brushes Spike Down **C007S**
- Replacement Square Base Brushes **C008**
- Replacement Side Brushes **C009**

**SHOE CLEANER CONSOLE**

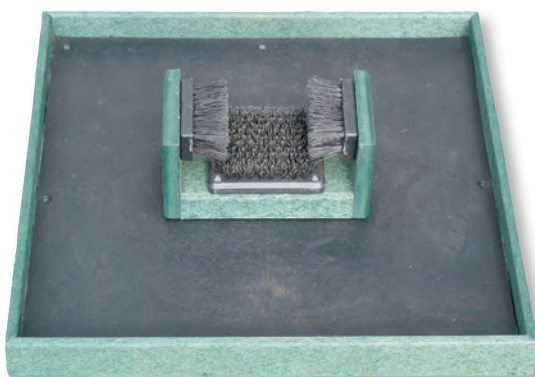

This handy spike cleaner helps keep the area neat and clean. Made from GreenWood™, the tray catches the grass clippings before they get spread everywhere. Simply lift and dump into a trash container when it fills up.

**C011C**

**SCRUSHER**

This effective cleaner cleans both the sides and bottom of shoe. Dirt falls through to prevent clogging.

- ST14100** Scrusher
- ST14106** 6" Asphalt Spike (4 Required)
- ST14124** 18" Turf Stake (4 Required)



STANDARD  
GOLF COMPANY

SIGNAGE  
RANGE & PRACTICE  
TEE AREA  
FAIRWAY  
GREENS  
CLUBHOUSE, PRO SHOP, & TOURNAMENT  
RECYCLED PLASTICS  
SAFETY, MAINTENANCE, & IRRIGATION



SIGNAGE

RANGE & PRACTICE

TEE AREA

FAIRWAY

GREENS

CLUBHOUSE, PRO SHOP, & TOURNAMENT

RECYCLED PLASTICS

SAFETY MAINTENANCE, & IRRIGATION



## PENCILS

Hex, round imprinted or plain we now have all of your pencil needs covered. With or without erasers, Eagle One can now provide you with any color or style of scorer's pencil. Made of durable cedar with clear finish.

**C401** Pencils Call for Quote

## BULK AND BAGGED TEES

Eagle One is now pleased to be able to assist you with all of your golf ball tee needs. Bagged or bulk 2 1/8", 2 3/4" and 3 1/4". We also carry Zero Friction Tees which have 3 prongs and really do add distance and accuracy. Zero Friction is the official tee of the PGA of America. Your customers will ask for them by name - Zero Friction. All tees can be personalized.

Hardwood Golf Tees			
Bulk Tees Price per 1,000 Tees		Bagged Tees Price per 1,000 Tees - 10M Minimum Order	
Waterbase		Waterbase	
Part #	Length	Part #	Length
P06221/8	2 1/8	P06221/8B	2 1/8
P06223/4	2 3/4	P06223/4B	2 3/4
P06231/4	3 1/4	P06231/4B	3 1/4

\* 4" tee is the longest allowed by the USGA and only is available in natural. Available upon request. Call for Pricing.

Tees come in the following stock colors: Natural, White and Mixed Colors. Tees also available in assorted colors. Please call for availability on colors and sizes.



## BALL SPOTTERS

Please call for quote.



- CMBSDP** Plain Dime Size
- CMBSQMP** Plain Quarter Size
- CMBSDI** Imprinted Dime Size, 1 Color
- CMBSDI2** Imprinted Dime Size, 2 Color
- CMBSQMI** Imprinted Quarter Size, 1 Color
- CMBSQMI2** Imprinted Quarter Size, 2 Color





CM250-P & CM250-S

**CART AND BAG TAGS**

Eagle One offers a complete array of bag identification tags and cart key tags. Bag Tags are a great way of saying thank you to customers and getting your name out to other golfers. Made of unbreakable plastic, these tags and cart tags are a must for every course. Please call for quote.



CM385-S



CM400-P



CM450-S



CM462-R



CM275-P & CM275-S



CM475-S



CM485-P & CM485-S



CM490-CT  
CM490-P & CM490-S



CM495-S

**RENTAL GOLF CART**

Sturdy steel frame with rugged plastic wheels.

**C140** Call for Quote



**BALL MARK REPAIR TOOLS**

Please call for quote.



CMBMR



CMBMRC



CMBMRM

SIGNAGE

RANGE &  
PRACTICE

TEE AREA

FAIRWAY

GREENS

CLUBHOUSE,  
PRO SHOP, &  
TOURNAMENT

RECYCLED  
PLASTICS

SAFETY,  
MAINTENANCE,  
& IRRIGATION



## **GOLF BAG MOBILE & STATIONARY STORAGE SYSTEM**



Eagle One Golf Products, with its 30 years of experience in design, layout, and installation, will show you how to make the most of your storage space. Just provide us with the number of golf bags you need to store and the measurements of the area we have to work with. We will provide you with a

cad drawing - showing the layout of your system along with the number of bags you wish to store. Our systems are unique because we can adjust, on 1½" centers, to any height requirements you request, allowing for the tallest drivers and putters.

We also have the capability to combine, or store separately, any golf products, supplies, and/or merchandising with our shelving systems from flat to hanging items.

SIGNAGE

RANGE & PRACTICE

TEE AREA

FAIRWAY

GREENS

CLUBHOUSE, PRO SHOP, & TOURNAMENT

RECYCLED PLASTICS

SAFETY MAINTENANCE, & IRRIGATION

## GOLF BAG MOBILE & STATIONARY STORAGE SYSTEM

### Features and Specifications:

- Shelves: 5/8" or 3/4" recycled grade AAA plastic (will not warp or absorb odors) surrounded by formed steel for support.
- Frame: 11 and 14 gauge industrial steel - 15" deep single-sided and 30" deep double-sided units available with the length constructed to the space available.
- Dividers: welded on 12" centers - accommodating the largest bags in the industry.
- Color: black shelves with gray frames and supports.
- End Panels: 20 gauge steel used for cosmetic and security purposes.
- Finish: baked enamel.
- Track and Carriages: constructed of aluminum and meet all OSHA and city requirements.

Call for Quote

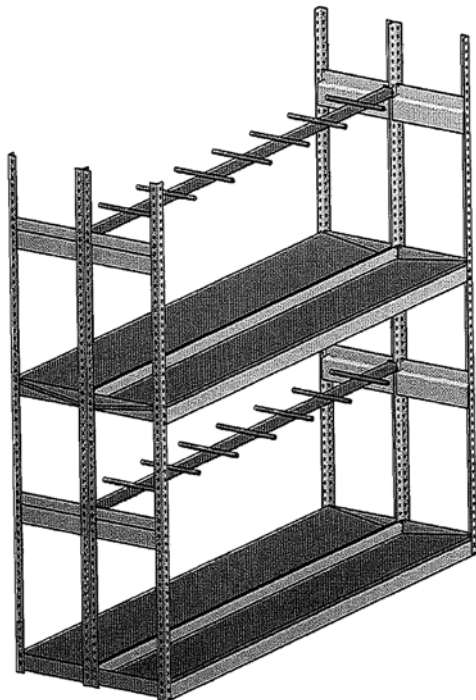



SIGNAGE  
RANGE & PRACTICE  
TEE AREA  
FAIRWAY  
GREENS  
CLUBHOUSE, PRO SHOP, & TOURNAMENT  
RECYCLED PLASTICS  
SAFETY MAINTENANCE, & IRRIGATION

## DECORATIVE SMOKING RECEPTACLES

These innovative designs take cigarette butt disposal to a whole new level. You will never have to lay eyes on a tray of revolting cigarette butts again. They are eco-friendly, custom designed, compliment any environment and will add character to your establishment.

- No messy sand
- 100% recyclable steel
- Weather resistant
- Easy disposal
- Safely receives hundreds of butts
- Secures easily to prevent theft



**CJ26810P** Palm Tree



**CJ26810SL** Single Lily



**CJ26810F** Flag

## CEASE-FIRE® CIGARETTE BUTT RECEPTACLES

The safe and attractive answer to cigarette butt disposal to keep your property clean. This product safely contains cigarette butts in an attractive housing specially designed to reduce the risk of fire. Durable, flame retardant polyethylene won't rust or crack. 38.5" high, Polyethylene with Liner Pail.

- CJ26800** Pewter Gray
- CJ26800B** Adobe Beige
- CJ26800D** Deco Black
- CJ26800G** Forest Green
- CJ26800T** Terra Cotta





**WALL MOUNTED MESSAGE BOARDS**

Able to mount on any wall this GreenWood™ message board has clear lexan sliding doors and ½" cork backboard. Many colors to choose from. 37½" L x 6" W x 26" H

**C401** Wall Mounted Message Board

**MESSAGE BOARDS**

This weather resistant cabinet is for displaying your important messages. The frame and support posts are constructed from GreenWood™. Clear sliding doors are durable lexan and inside backing is lined with cork. Cabinet is 3' high by 4' wide, and the posts are 4" x 4" x 7'. Available in Black, Brown, Driftwood, Green and White.

**C400**



**NOW WITH ½" CORK!**

**MOVABLE MESSAGE BOARDS**

This movable double sided message board comes fully assembled and mounted on 4 heavy duty lockable castor wheels. Made of 100% GreenWood™ the complete unit is 80" wide x 80" high with a cork message area on both sides. Available in black, brown, driftwood, green and white.



**NOW WITH ½" CORK!**

Similar to our conventional message boards except we use a larger header that can hold your logo. This message board can be either single or double sided. Call to discuss.

**C405X**



**C405**

SIGNAGE

RANGE &  
PRACTICE

TEE AREA

FAIRWAY

GREENS

CLUBHOUSE,  
PRO SHOP, &  
TOURNAMENT

RECYCLED  
PLASTICS

SAFETY,  
MAINTENANCE,  
& IRRIGATION



SIGNAGE

RANGE & PRACTICE

TEE AREA

FAIRWAY

GREENS

CLUBHOUSE, PRO SHOP, & TOURNAMENT

RECYCLED PLASTICS

SAFETY MAINTENANCE, & IRRIGATION



## PREMIUM SPECIAL EVENT RECORDERS

Eagle One's new Long Drive Recorder is great for all of your tournament long drive needs. Since most long drive recorders are under 2 feet high, visibility from the tee box is nearly impossible. This unit however stands over 5 feet tall and can be seen at long distances. 3 spikes on the bottom plate pushes into the turf as the distance moves along. Recording area is made from dry erase material and an erasable grease pencil is included.



**S303**  
Long Drive Recorder

## EVENT RECORDERS



**S307CTPT100**  
Closest To Pin  
with 100' Tape



**Measure From  
Ball To Hole**

**S307CTPT50**  
Custom Closest To Pin  
with 50' Tape



**Measure From  
Hole to Ball**

**S304CTP**  
Closest To Pin with  
50' Tape



These exceptionally nice looking special event recorders are made from super durable laminated plastic and can easily accommodate your logo at a nominal cost. Names are recorded on special "dry erase" board using regular score card pencils that slip into a hole drilled in top of unit. Old names wipe clean with Windex or mild soap and water. Measuring tape units come with 50ft tape measures. We also offer a special order 100ft tape measure on request. Closest to pin- S307CTP (no tape) will come with a 24" spike, S307CTPT (with tape) is made with a 6" spike for easy measuring. The same spike lengths apply to the S307SD and S307SDT straightest drive recorders. The S307LD longest drive is not available with tape and there is a generic version that doesn't stipulate a specific event allowing many uses.

\*Also available with Metric tape measures.



**SPECIAL EVENT  
RECORDERS**

**S305**  
Special Events Recorder  
(complete set of 4)

**S305RP**  
Recording Card Packs (25)  
(1 pack of 25)

**SIGHT SCREENING**

- R09868** 66" x 50'
- R09892** 92" x 50'
- R098C** Custom Width and Height

Screen away those unattractive sights or block the view during tournaments using this long lasting privacy mesh. Also excellent for wind control around back of bleachers or stands. Made from UV stabilized polyethylene it is available in five sizes.

Maximize efficiency by utilizing your sight screening as an advertising, sponsorship or informational opportunity. By screening your logo or message, attention can be diverted from a barrier, to presenting billboard space. Other uses can include construction information or traffic diversion. Please be sure to order in advanced as normal lead times for this process are approximately 2-3 weeks.

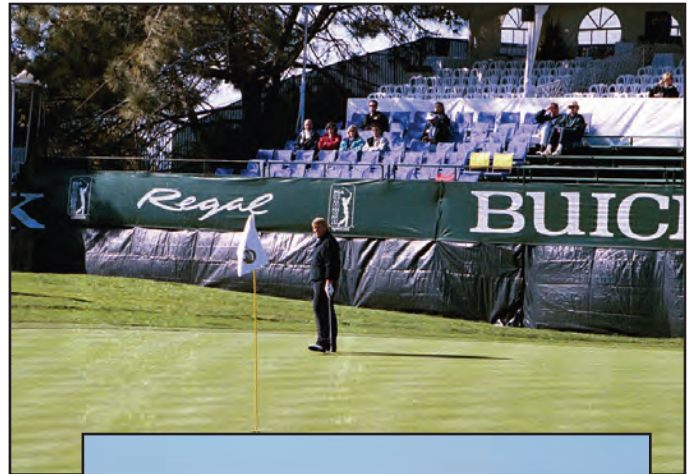

**CROWD CONTROL FENCING**



For fencing off hazardous areas or tournament crowd control. Green or Orange.

- R090G** Green 4' x 50'
- R0900** Orange 5' x 50'
- R095** Post Steel Fence



SIGNAGE

RANGE &  
PRACTICE

TEE AREA

FAIRWAY

GREENS

CLUBHOUSE,  
PRO SHOP, &  
TOURNAMENT

RECYCLED  
PLASTICS

SAFETY,  
MAINTENANCE,  
& IRRIGATION



SIGNAGE  
RANGE & PRACTICE  
TEE AREA  
FAIRWAY  
GREENS  
CLUBHOUSE, PRO SHOP, & TOURNAMENT  
RECYCLED PLASTICS  
SAFETY MAINTENANCE, & IRRIGATION



For your Mini Putt needs, Eagle One now offers a variety of products just for you.

## MINI GOLF PUTTERS

Miniature Golf Putters. Available in 3 sizes these durable putters have soft feel grips and hard rubber heads. Many colors available. Call for details.

**J100** Complete Putter

**J101** Putter Grip Only



## MINI GOLF BALLS

Miniature Golf Balls. Attractive pastel, neon or regular colors, and very affordable.

**J102** per dozen

Floater Miniature Golf Balls. Same attractive colors and they float. If you have water features this ball is for you.

**J102F** per dozen





**MINI GOLF PUTTER RACK**

This super sturdy putter rack is made of 100% maintenance free recycled plastic. These racks make it easy to store and retrieve your rental putters. Available in green, brown, driftwood black and white.

**J300** Putter Rack



**MINIATURE GOLF  
BALL VENDOR**

Ideal for counter tops. The unbreakable clear lexan on the front allows you to see your ball stock. Unit comes standard with 5 columns. Each column holds up to 11 balls.

Please call to discuss custom sizes.

**J030**  
Golf Ball Vendor

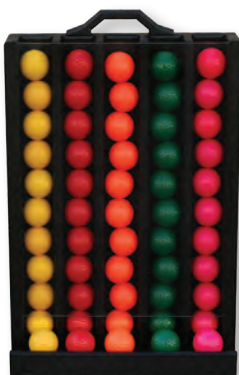

**SCORE PAD**

This handy little score pad has a sheet of clear lexan on the top that allows you to slide a standard sheet of paper under the face. Put on a tee box so your customers can write their scores down and use as a tee sign or advertise your snack bar menu at the same time. Made of 100% maintenance free recycled plastic.

**J015** Score Pad



**GOLF BALL DISPLAY**

This great looking ball display has a piece of unbreakable clear lexan on the front that allows you to see your ball stock. Clean, neat and affordable.

**J020** Golf Ball Display



- SIGNAGE
- RANGE & PRACTICE
- TEE AREA
- FAIRWAY
- GREENS
- CLUBHOUSE, PRO SHOP, & TOURNAMENT
- RECYCLED PLASTICS
- SAFETY, MAINTENANCE, & IRRIGATION

# FULL CUSTOMIZATION!

If you can dream it, we can make it!  
Any recycled plastics products can be designed with your logo.  
Please call for a quote and details.



SIGNAGE

RANGE & PRACTICE

TEE AREA

FAIRWAY

GREENS

CLUBHOUSE, PRO SHOP, & TOURNAMENT

RECYCLED PLASTICS

SAFETY MAINTENANCE, & IRRIGATION

**HUNTINGTON BAR AND STOOLS  
OR STARTERS CONSOLE**



These portable bars are indispensable when entertaining and are sturdy enough to be used for both residential and commercial use. They work great for caterers or people that need the flexibility of moving from place to place. The portable bar moves easily on sturdy non-marking swivel casters. Locking brakes on rear wheels hold the bar securely in place during use. Customized versions of this Portable bar are available upon request. All bars come fully assembled, no tools necessary so you can use them right away. Our bar stool is a classic backless stool whose design easily fits into any bar or outdoor area setup. Made of 100% GreenWood™, these bar stools are low maintenance and easy to clean.



- A. **C900S** Huntington Bar
- B. **C900L** Huntington Big Bar
- C363** Bar Stool
- T071UA** Umbrella Attachments
- C920X** Sunbrella Umbrella
- C921X** 8oz Polyester Umbrella



**ROUND PICNIC TABLE AND CHAIRS**



- C370T** Rockingham Round Table
- C361C** Alexandra Chair
- C960X** Alexandra Chair Cushion
- C920X** Sunbrella Umbrella
- C921X** 8oz Polyester Umbrella
- C361L** Porch/Deck Chair



SIGNAGE

RANGE &  
PRACTICE

TEE AREA

FAIRWAY

GREENS

CLUBHOUSE,  
PRO SHOP, &  
TOURNAMENT

RECYCLED  
PLASTICS

SAFETY,  
MAINTENANCE,  
& IRRIGATION

SIGNAGE  
RANGE & PRACTICE  
TEE AREA  
FAIRWAY  
GREENS  
CLUBHOUSE, PRO SHOP, & TOURNAMENT  
RECYCLED PLASTICS  
SAFETY MAINTENANCE, & IRRIGATION



**CAPE COD TABLE**

Eliminate tedious painting and repair projects by outfitting your course and clubhouse with maintenance free furniture! Available in Black, Brown, Driftwood, Green and White. Shipped "knocked down" to reduce shipping costs. Available with an umbrella hole option.

- C38542** 42" Table
- C38560** 60" x 38" Table
- C920X** Sunbrella Umbrella
- C921X** 8oz Polyester Umbrella



**CAFE TABLE**



**LC825S**  
Square

Our Cafe Table is the ideal choice for casual dining anywhere space may be limited.



**LC825R**  
Round

**CAFE LOUNGE COLLECTION**



An Eagle One original design. The Cafe Lounge Collection of elegant outdoor/indoor furniture is casual, comfortable and roomy enough to satisfy everyone. Crafted from low maintenance 100% GreenWood™ Recycled Plastic Lumber to withstand the wear and tear of outdoor use in any weather. GreenWood™ Recycled Plastic Lumber will never chip, rot, split or ever need painting. You'll be able to entertain and lounge for years. The Cafe Lounge Collection has been redesigned and is now modularly built for very uncomplicated assembly. The new modular construction makes it uniquely able to fit your individual needs.

Fabric Cushions are included with each unit. Call to discuss other fabric options.



- A. **LC813AC** Chair
- B. **LC813LC** Chair Left Arm
- C. **LC813RC** Chair Right Arm
- D. **LC813C** Chair Without Arms
- E. **LC813CR** Corner Chair
- F. **LC8070** Ottoman

- G. **LC812ET** End Table
- H. **LC812CT** Coffee Table
- I. **LC813LS** Love Seat
- J. **LC813S** Sofa
- K. **LC813SEC** Sectional

SIGNAGE

RANGE &  
PRACTICE

TEE AREA

FAIRWAY

GREENS

CLUBHOUSE,  
PRO SHOP, &  
TOURNAMENT

RECYCLED  
PLASTICS

SAFETY,  
MAINTENANCE,  
& IRRIGATION

SIGNAGE  
RANGE & PRACTICE  
TEE AREA  
FAIRWAY  
GREENS  
CLUBHOUSE, PRO SHOP, & TOURNAMENT  
RECYCLED PLASTICS  
SAFETY MAINTENANCE, & IRRIGATION

## MALL BENCHES



Three 2 x 4 slats shown



Three 2 x 4 slats shown

GreenWood™ "mall" style bench. Tough, low maintenance and durable. Many color combinations! Legs available in Green, Brown, Cedar, and Black. Shipped "knockdown" for easy transit. Slats are 2 x 4 as standard.

- T238** 4' Long, 2 x 4 slats
- T239** 7' Long, 2 x 4 slats

## HIGH BACK BENCHES



100% GreenWood™ seat slats, and solid recycled plastic legs. This is a very tough, sturdy and virtually no maintenance product. Standard in either 4' or 7' lengths. Custom lengths available. Different color combinations are available. Legs available in: Green, Brown, Cedar, and Black. Shipped "knock down" for easy transit. Standard slats are 2 x 4.

- T230** 4' Long 2 x 4 Slats
- T232** 7' Long 2 x 4 Slats

## PARK STYLE PICNIC TABLES AND CHAIRS

We offer many forms of picnic tables depending on your needs. All feature durable and maintenance free 2" x 10" GreenWood™ tops and seats with various sub structures of GreenWood™ or steel. We have wheel chair accessible models and various lengths for specific needs. The most common tables are 6' long and are available in numerous colors or color combinations.



- C350** 6' All GreenWood™
- C350H** 8' All GreenWood™ - Handicap
- C355** 6' GreenWood™ Top With Steel Frame
- C355H** 8' GreenWood™ Top With Steel Frame - Handicap

Some assembly required.





**HERITAGE BENCHES**

Modeled after traditional teak wood benches this GreenWood™ bench offers the best in style and durability. The seat area is contoured for comfort and arm rests are convenient when relaxing. Cushions are not included though can be supplied. Available in Black, Green, Driftwood, Brown, Cedar, and White and mixed color combinations. (Trash can not included.)

- T2452** 2' Chair
- C922X** 2' Bench Cushion
- T2454** 4' Bench
- C924X** 4' Bench Cushion
- T2456** 6' Bench
- C926X** 6' Bench Cushion

**SANTA FE BENCH**

The Santa Fe Bench offers comfort and style and requires minimal maintenance. Made from 100% GreenWood™ recycled plastic lumber, the Santa Fe will never chip, rot, split or ever need painting.

Modeled after traditional wood benches, this GreenWood™ recycled plastic lumber bench offers the best in style and durability. The seat area is contoured for comfort and arm rests are convenient when relaxing. Cushions are not included though can be supplied.

- DDT2455** 5' Santa Fe Bench
- C992X** 5' Santa Fe Bench Cushion



**CHIPPENDALE BENCH**

This super comfortable bench looks great and will require little, if any maintenance. Made from 100% GreenWood recycled plastic lumber, the Chippendale Bench is designed with a contoured seat, backrest and arm rests. Offered in three different sizes, this is one bench that looks great anywhere you put it- ideal for tee boxes, clubhouse, pool or tennis courts.

- LCCB48** 4' Bench
- LCCB60** 5' Bench
- LCCB72** 6' Bench



SIGNAGE

RANGE & PRACTICE

TEE AREA

FAIRWAY

GREENS

CLUBHOUSE, PRO SHOP, & TOURNAMENT

RECYCLED PLASTICS

SAFETY, MAINTENANCE, & IRRIGATION

SIGNAGE

RANGE & PRACTICE

TEE AREA

FAIRWAY

GREENS

CLUBHOUSE, PRO SHOP, & TOURNAMENT

RECYCLED PLASTICS

SAFETY MAINTENANCE, & IRRIGATION



## PODIUM ON POST

Place this podium in the vicinity of the first tee to record tee off times. The marshal can now control group times. Made from 100% GreenWood™. Lid collapses down to seal the unit when not in use. The box is 24" long x 10" wide x 6" deep. Comes with a 4" x 4" x 5' post.

T070NE



## DESIGNER'S PODIUM

A modern simple design makes this a great podium for welcoming guest, cart assignment attendants or first tee starters. Available in most colors and color combinations.

T073



## DIRECTOR'S PODIUM

This GreenWood™ half size podium is great for tournament directors or starters. The lockable castor wheels make it exceptionally easy to store away at night. Lots of storage area with lockable hasp on request. Available in Green, Black, Brown and Driftwood.

T072NE







**FULL PODIUM**

Built for outdoor durability from Greenwood™, this starters' podium features a sloping work top that lifts up for storage of documents, radios, etc. It is a comfortable work height.

Dimensions: 23" Wide, 21" Deep, 28.5" High (Front), 40" High (Back).

- T071NE** New England Pattern
- T071WHNE** New England Pattern With Wheels
- T071UA** Umbrella Attachments
- C920X** Sunbrella Umbrella
- C921X** 8oz Polyester Umbrella



**ARCH DESIGN PODIUM**

For your greeter or starter, this fantastic looking podium will give you years of use with little to no maintenance required. Logos or messages can be added for a nominal up charge, call to discuss. Made of 100% Greenwood™ Recycled Plastic with many color combinations available.

**T069A**



**EXTRA LARGE PODIUM**

This extra large starters podium is ideal for multi staff greeters or starters. Plenty of storage in lower cabinets and top enclosed hatch. Logos can be added for a nominal upcharge.

**T069AXL**



SIGNAGE

RANGE &  
PRACTICE

TEE AREA

FAIRWAY

GREENS

CLUBHOUSE,  
PRO SHOP, &  
TOURNAMENT

RECYCLED  
PLASTICS

SAFETY,  
MAINTENANCE,  
& IRRIGATION

SIGNAGE

RANGE & PRACTICE

TEE AREA

FAIRWAY

GREENS

CLUBHOUSE, PRO SHOP, & TOURNAMENT

RECYCLED PLASTICS

SAFETY MAINTENANCE, & IRRIGATION



**CHESAPEAKE ADIRONDACK CHAIRS**

We are excited to introduce our new Chesapeake Adirondack Chair this year. The Chesapeake offers the utmost in comfort through simple and classic design. You'll savor the sunshine on one of the most comfortable patio chairs you'll ever own, knowing the longevity of 100% GreenWood™ will never chip, rot, split or ever need painting. Cushions are not included though can be supplied. Please Specify Color When Ordering

- C420** Chesapeake Adirondack Chair
- C995X** Chesapeake Adirondack Chair Cushion
- C420FS** Chesapeake Foot Stool



**COZY ADIRONDACK CHAIRS**

This great looking 100% recycled plastic Adirondack Chair is priced for every budget. Perfect for ranges and clubhouses it will never need painting and requires zero maintenance. The optimal pullout leg rest adds a unique and convenient design.



- C428** Chair
- C428L** Chair with Leg Rest

**CLASSIC ADIRONDACK CHAIRS**

This distinguished traditional chair with a brand new design is ideal at the driving range or around the clubhouse. Made from GreenWood™, so maintenance is almost nil, lasting for years. The optimal pullout leg rest adds a unique and convenient design. Available in Black, Brown, Driftwood, Green, and White. Cushions are not included though can be supplied. Please specify color when ordering.

The pullout leg rest option draws out of the chair with ease and style.



- C425** GreenWood™ Adirondack Adirondack Chair Cushion
- C425-** Adirondack Chair with
- C425LR** Pullout Leg Rest



**NANTUCKET PLANTER BOXES**

SKU	Description	L	W	H	Wt
C50012NE	Nantucket New England	11.5"	12.5"	12"	13 lbs
C50017NE	Nantucket New England	17"	16"	12"	21 lbs
C50034NE	Nantucket New England	34"	12"	12"	27 lbs
C50048NE	Nantucket New England	48"	12"	12"	42 lbs

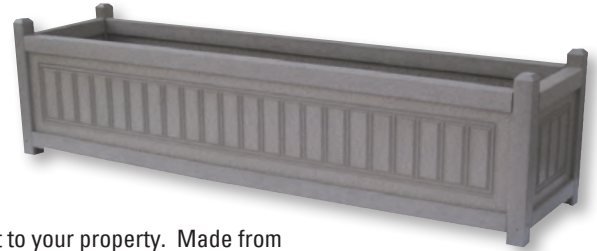

Offering great style without compromising durability these planters are a great asset to your property. Made from GreenWood™ that doesn't rot, split, corrode or rust they eliminate most of the maintenance problems associated with natural or painted wood planter boxes. The Nantucket style is finished with 2" x 2" framing at the corners. The height of these boxes is 14" (including the 2" x 2" corners). Custom face engraving may also be possible including logos and numbering if desired. The Catalina model provides a simpler design, and these boxes are 12" high.

**CATALINA PLANTER BOXES**

SKU	Description	L	W	H	Wt
C50512NE	Catalina New England	11.5"	12.5"	12"	10 lbs
C50517NE	Catalina New England	17"	16"	12"	16 lbs
C50534NE	Catalina New England	34"	12"	12"	20 lbs
C50548NE	Catalina New England	48"	12"	12"	24 lbs



**NORTH HAMPTON PLANTER BOXES**

SKU	Description	L	W	H	Wt
C49512NE	North Hampton New England	11.5"	12.5"	12"	13 lbs
C49517NE	North Hampton New England	17"	16"	12"	23 lbs
C49534NE	North Hampton New England	34"	12"	12"	28 lbs
C49548NE	North Hampton New England	48"	12"	12"	43 lbs



With all the benefits of the Nantucket style planter boxes, the North Hampton style features a 'lip' running around the top edges. Custom face engraving may also be possible including logos and numbering if desired. These boxes are all 12" high.

**CUSTOM PLANTER BOXES**



Custom sizes, patterns, engravings and signs are all possible. Please call to discuss your requirements.



SIGNAGE

RANGE &  
PRACTICE

TEE AREA

FAIRWAY

GREENS

CLUBHOUSE,  
PRO SHOP, &  
TOURNAMENT

RECYCLED  
PLASTICS

SAFETY,  
MAINTENANCE,  
& IRRIGATION

SIGNAGE  
RANGE & PRACTICE  
TEE AREA  
FAIRWAY  
GREENS  
CLUBHOUSE, PRO SHOP, & TOURNAMENT  
RECYCLED PLASTICS  
SAFETY MAINTENANCE, & IRRIGATION

## FREE STANDING REFRIGERATED DRINKING FOUNTAIN

These units are constructed from a durable stainless steel shell with a vandal resistant double bubbler. It has an easy clean anti-splash rim receptor. One model is for use in exterior, undercover applications. The second model is unique as it is designed for exterior exposed situations found on a golf course. Although both units are U.L. Listed it should be noted that the "exterior exposed" model is the only one offered for sale in the USA with this important and liability reducing safety listing. A drop-over housing, made from GreenWood™ can be added, that simulates the look of our T279 model drinking fountain shown below. If you plan to use it in potentially freezing areas, please request a unit designed for this environment. Covers sold with water coolers only.



- T280** Exposed Applications, Free Standing
- T280U** Undercover Applications, Free Standing
- T281** Exposed Applications, Wall Mount
- T281U** Undercover Applications, Wall Mount

## GREENWOOD™ FOUNTAINS AND COVERS

With choices from GreenWood™ refrigerated fountains to drop over covers to drop over covers with lids, we have everything you need. Covers include a trap door to provide easy access to the plumbing.

In addition to the aesthetic appeal, our covers add great protection to the light gauge steel sheeting of regular drinking fountains. Depending on your model the cover may need to be custom made for you. All covers are made to order. Green or driftwood are standard though other colors may be available.

We can also supply a cover with a spring-loaded hinge to protect the fountain and drinking area from reclaimed water.

Dimensions: Width - 17 1/4", Depth - 16", Height - 39 1/2"

**T279DP**



**T282C**  
Custom Cover  
with Logo  
Call For  
Quote

**T282**  
Cover for Halsey Taylor

**T283**  
Cover For Halsey Taylor  
With Hinged Lid

**T283C**  
Custom Cover With  
Hinged Lid

**DOUBLE COLD BEVERAGE CONTAINER**



This unit includes two removable 10 gallon ice chest that will keep cans and bottles cold all day long. Most colors and color combinations are available.

**T336**  
GreenWood™ Double Cold Beverage Storage Container



**COLD BEVERAGE CONTAINER**

This unit includes a removable 10 gallon ice chest that will keep cans and bottles cold all day long. Most colors and color combinations are available.

**T335**  
GreenWood™ Cold Beverage Storage Container



**LOW PROFILE COLD BEVERAGE CONTAINER**

This container holds a removable ice chest (included) that can easily be emptied or refilled. The Low Profile Container is available in a variety of colors and is extremely durable. Perfect for tee boxes or around the Clubhouse.

**T338**



**TOWEL DIP STATION**

Made of 100% recycled plastic this great new product allows your customer to wet a towel before their rounds. Includes an easy to remove 5 gal bucket. Towels are not included.

**C050** Towel Dip Station



SIGNAGE

RANGE &  
PRACTICE

TEE AREA

FAIRWAY

GREENS

CLUBHOUSE,  
PRO SHOP, &  
TOURNAMENT

RECYCLED  
PLASTICS

SAFETY,  
MAINTENANCE,  
& IRRIGATION

SIGNAGE  
RANGE & PRACTICE  
TEE AREA  
FAIRWAY  
GREENS  
CLUBHOUSE, PRO SHOP, & TOURNAMENT  
RECYCLED PLASTICS  
SAFETY MAINTENANCE, & IRRIGATION



5 Gallon

**IGLOO COOLER**

- T2655** Water Cooler - 5 Gallon  
Dark Green
- T265DG** Water Cooler - 10 Gallon  
Dark Green
- T26510S** Spigot
- T270** Plastic Cup Dispenser With Lid
- T270CLIP** Cup Dispenser Clip/Bracket
- T270LID** Lid For Cup Dispenser
- T272** Water Cooler Cups  
4oz - 5000/Pack



10 Gallon

**FOLDING TRIPOD COOLER STAND**

Support your 5 or 10 gallon cooler with these compact stands. Made of 100% GreenWood™, these units fold up for easy transport and storage. Excellent for tournaments. Available in Black, Green, Brown and Driftwood. (Igloo Cooler Not Included.)

**T2785**  
Tripod Water Cooler Stand For  
5 Gallon Igloo Cooler

**T278**  
Tripod Water Cooler Stand For  
10 Gallon Igloo Cooler



5 Gallon

10 Gallon

**WATER GUARDIAN**

- No more contaminated or bad tasting water.
- Eliminate the need to sanitize the dispenser and valve.
- Assure integrity of the product.
- Keeps cold products colder and hot products hotter.
- Pinch valves are reusable as the water never touches the spout.

**T271** Case of 50 Bags

**T271V** Single Pinch Valve



**VERTICAL SLATTED COOLER HOUSING**



- A. **T263T** Cooler Housing On Tripod Stand
- B. **T263** Cooler Housing For Post And Base (Not Included)
- T263PB** 4" x 4", 34" GreenWood™ Post With 1 1/2" Long Steel Pipes On Each End For Use With Hexagon Base
- T265DG** 10 Gallon Cooler (Sold Separately)
- T112B** Base With Spikes
- T12034** 34" Long Powder Coated Steel Post
- T12072** 72" Long Powder Coated Steel Post

Water Cooler on post with feet. Our most popular round recycled plastic water cooler mounted on a recycled post with feet. Great for standing on turf.

- T263RPF** 4" x 4" Post, Feet Base (Post And Base Only)



**CANOPY WATER COOLER HOUSE**

Durable, maintenance free GreenWood™ that will hold a 10 gallon water cooler. 68" high, 23" wide and 19" deep. (Cooler, cup dispenser not included)

- T291NE** New England Pattern
- T291NEBLKBRN** New England Pattern, Black With Brown Trim
- T291NEGBRN** New England Pattern, Green With Brown Trim
- T291NEBLKD** New England Pattern, Black With Driftwood Trim
- T291NEGC** New England Pattern, Green With Cedar Trim
- T265DG** 10 Gallon Water Cooler
- T269** Clear Plastic Cup Dispenser
- T270** Cup Dispenser



SIGNAGE

RANGE &  
PRACTICE

TEE AREA

FAIRWAY

GREENS

CLUBHOUSE,  
PRO SHOP, &  
TOURNAMENT

RECYCLED  
PLASTICS

SAFETY,  
MAINTENANCE,  
& IRRIGATION

**FULL LENGTH WATER COOLER HOUSE**



Our self contained Greenwood™ cooler house encloses a 10 gallon water cooler on top and a 10 gallon trash container below. There is a "Cup Hole" access, allowing the cup dispenser to be neatly contained inside the cooler house. Available colors are: Green, Brown, Driftwood and Black. Includes trash bin. Dimensions: 66" Peak, 23" wide, 59" high, 19" deep. (Cooler, cup dispenser and logo not included)

New England Pattern Cooler  
**T290NE**

Clear Plastic Cup Dispenser  
**T269**

Cup Dispenser  
**T270**

10 Gallon Water Cooler -  
Dark Green  
**T265DG**

**ARCH DESIGN WATER COOLER HOUSE**



Our most popular water cooler house with the color design of your choice. Use your club colors or add your logo. Lower area contains a 10 gallon trash bin included. (Cooler, cup dispenser not included)

**T290AF**  
Arch Design Full Length Water Cooler House With Color Fill

**ARCH DESIGN CANOPY WATER COOLER HOUSE**



Our newest engraving design will look fantastic on any golf course or driving range. (Cooler, cup dispenser not included)

**T291A**  
Arch Design Canopy Water Cooler House

**TWO TONE GREENWOOD™ WATER COOLER HOUSE**

**T290NEBLKBRN**  
New England Pattern, Black With Brown Trim

**T290NEGBRN**  
New England Pattern, Green With Brown Trim

**T290NEGD**  
New England Pattern, Green With Driftwood Trim

**T290NEDBRN**  
New England Pattern, Driftwood With Brown Trim

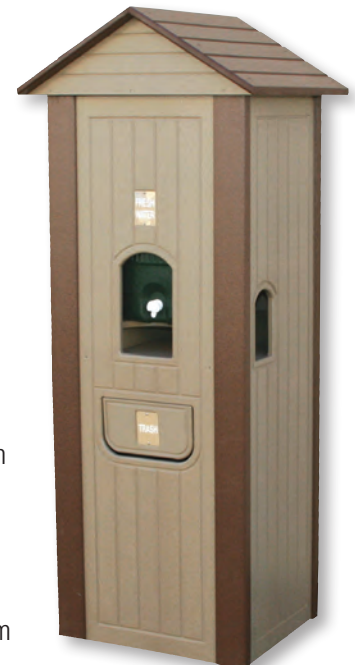

(Cooler, cup dispenser not included)

SIGNAGE  
RANGE & PRACTICE  
TEE AREA  
FAIRWAY  
GREENS  
CLUBHOUSE, PRO SHOP, & TOURNAMENT  
RECYCLED PLASTICS  
SAFETY MAINTENANCE, & IRRIGATION



**DOUBLE WATER  
COOLER ENCLOSURES**

If you have a thirsty group this is the cooler for you. Using the same construction as our T290 water coolers, we developed the "double," housing two 10 gallon cooler units side by side with dual 10 gallon trash bins below. Cut outs allow access to the cup holders on each unit. Includes trash bin. Coolers and cup dispensers not included. Dimensions: 66" Peak, 46" wide, 59" high, 19" deep.

**T292**



**WATERCOOLER / CABINET  
COMBINATIONS**

Adding versatility to our T290 watercooler these units allow for the service of other amenities such as ice, plates, napkins etc. Lower cabinet can be locked and cabinet floor is 4" off the ground. The addition of a clock to the front face is possible though the unit will need to be made to order. Includes trash bin. Available in Driftwood, Brown, Green and Black. Coolers and cup dispensers not included.

**T273**

**T293**



**CLASSIC WATER  
STATION**

This great looking water station ties in with all of our new arch design products. Made of 100% recycled plastic. Clock and Logo are extra.

**T296**



SIGNAGE

RANGE &  
PRACTICE

TEE AREA

FAIRWAY

GREENS

CLUBHOUSE,  
PRO SHOP, &  
TOURNAMENT

RECYCLED  
PLASTICS

SAFETY,  
MAINTENANCE,  
& IRRIGATION

## 10 GALLON TRASH RECEPTACLES

Weather proof 100% GreenWood™ constructed 10 gallon Trash Container. Features GreenWood™ frame, three pointed slats for anchoring and a heavy duty GreenWood™ donut lid. All units include easily removable plastic bin. Color choices are Black, Green, Brown and Driftwood.

**T322**



## 20 GALLON TRASH RECEPTACLES



The Eagle One containers are weather proof with GreenWood™ slats, on powder coated, zinc-dipped, steel frames. The 20 gallon plastic bucket removes easily for dumping. It sits on the ground, or on either a spike base for ground protection, or ball washer base. Available in Green, Brown, Black and Driftwood. Trash Container comes with a Plastic Lid. You have the option to upgrade to Donut or Color Filled Lid.

- T171** 20 Gallon Container
- T171RL** Donut Lid
- T171LID** Plastic Lid Replacement
- T171RLF** Color Filled Lid
- T112B** Round Base

- T1206** 6" Support Pipe To Connect To T112B Base
- T171BIN** 20 Gallon Replacement Bucket
- T302** Spike Base for T301 & T171



Plastic Lid



Donut Lid



Color Filled Lid



Spike Base

## 22 GALLON TRASH RECEPTACLES

Similar to their 20 gallon counterparts, these 22 gallon containers feature thinner, tighter slats creating a barrel-style design. GreenWood™ frames and a GreenWood™ donut lid make this one of the more durable trash containers we offer. Available colors are Green, Brown, Black and Driftwood.

Includes an internal trash bin. Trash Container comes with Donut Lid. You have the option to upgrade to Color Filled Lid.

- T195** 22 Gallon
- T195RL** Donut Lid
- T195RLF** Color Filled Lid



Donut Lid



Color Filled Lid



SIGNAGE  
RANGE & PRACTICE  
TEE AREA  
FAIRWAY  
GREENS  
CLUBHOUSE, PRO SHOP, & TOURNAMENT  
RECYCLED PLASTICS  
SAFETY MAINTENANCE, & IRRIGATION

**22 GALLON TRASH RECEPTACLES**

These 22 gallon trash receptacle are made with 100% GreenWood™ with an easy lift 22 gallon roto molded plastic trash bin. Great looking and maintenance free. Available colors are Green, Brown, Black and Driftwood. Includes an internal trash bin. Dimension 31”L x 18”D x 18”H

**T199**



**32 GALLON TRASH RECEPTACLES**

Trash Container comes with a Plastic Lid. You have the option to upgrade to Dome Lid.

- T172** 32 Gallon (Bin Included)
- T172DOME** Dome Lid For T172
- T172LID** Plastic Lid
- T172BIN** 32 Gallon Trash Bin



Plastic Lid

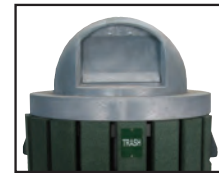

Dome Lid

**44 GALLON TRASH RECEPTACLES**

44 gallon units are made from weather-proof 1” x 4” GreenWood™ slats on a zinc-dipped and powder coated steel frame. The internal plastic bin removes easily for dumping. The frame accepts to a steel pipe in the base for permanent mounting in the ground or for attachment to a hexagon base. All units can be purchased with or without a dome lid that includes a spring loaded trap door. Standard slat colors are: Green, Brown, Black and Driftwood. Other colors are available upon request. The standard lid color is grey, though other colors may be available upon request. 44 Gallon Receptacles are 36” high with a 26” diameter.

Trash Container comes with a Plastic Lid. You have the option to upgrade to Donut, Color Filled, or Dome Lid.

- T173** 44 Gallon (Bin Included)
- T173RL** Donut Lid
- T173RLF** Color Fild Lid

- T173LID** Plastic Lid
- T174DOME** Dome Lid For T174 & T173
- T173BIN** 44 Gallon Trash Bin



Plastic Lid



Donut Lid



Color Filled Lid



Dome Lid

SIGNAGE

RANGE &  
PRACTICE

TEE AREA

FAIRWAY

GREENS

CLUBHOUSE,  
PRO SHOP, &  
TOURNAMENT

RECYCLED  
PLASTICS

SAFETY,  
MAINTENANCE,  
& IRRIGATION

SIGNAGE

RANGE & PRACTICE

TEE AREA

FAIRWAY

GREENS

CLUBHOUSE, PRO SHOP, & TOURNAMENT

RECYCLED PLASTICS

SAFETY MAINTENANCE, & IRRIGATION

**SQUARE "PULL TOP" TRASH RECEPTACLES**

Made from low maintenance GreenWood™. Includes a firm internal trash container for easy dumping and is accessed by lifting off the flat top. Color choices are Black, Driftwood, Brown and Green. Dimensions: 25" high, 21" wide and 21" deep.

**T180NE** 20 Gallon



**22 GALLON "PULL TOP" TRASH RECEPTACLES**

These units are all made from low maintenance GreenWood™ and include Eagle One's "New England" pattern decoration. Each unit includes a firm internal trash container for easy dumping and is accessed by lifting off the flat top. Color choices are Black, White, Brown, Driftwood and Green. Dimensions are 36½" high, 18" wide and 19" deep.

With Lexan Logo  
(Call For Quote)



**T188NE**  
22 Gallon



**T191NE**  
22 Gallon  
With Engraved  
Corner Trim

**"PULL TOP" ARCH DESIGN TRASH RECEPTACLES**



Our newest engraving design will look fantastic on any golf course or driving range. Includes a 22 gallon trash bin.

**T189AF**  
Arch Design Pull Top 22 Gallon Trash

Same new arch design except we color fill the engraved pattern with the colors of your choice. Many colors and color combinations are available, please call our customer service to discuss.

**T189AFF**  
Arch Design Pull Top 22 Gallon  
Trash With Color Fill



**ASH TRAY / TRASH RECEPTACLES**

Constructed from durable, almost maintenance free, GreenWood™ with a heavy duty powder coated steel ash tray top. Trap door contains odors and restricts insects. Steel lid lifts off for access to a 10 gallon rigid liner. Dimensions are 30" high, 17½" wide and 17½" deep. Available in Driftwood, White, Black, Brown and Green.

- C450NE** New England Pattern
- C450TRAY** Replacement Ashtray Top

With Lexan Logo  
(Call For Quote)



**ASHTRAY STAMP**

Incorporate a refined look to your ash trays by pressing your logo or message into the sand with this easy to use stamp. Custom made, this stamp can be cut to fit your specifications while dual colors assist in monitoring wear for maintaining that sharp line imprint. A convenient handle is featured on the back for easy removal and available in a variety of colors.

**C460**



**ANIMAL PROOF TRASH CONTAINERS**

Now you can enjoy the same secure enclosures used in State and National Parks to prevent animal intrusions. GreenWood™ siding make these products almost maintenance free. These great looking receptacles are the perfect solution to those pesky critters that always make a mess.

**T130**

**T131**



SIGNAGE

RANGE &  
PRACTICE

TEE AREA

FAIRWAY

GREENS

CLUBHOUSE,  
PRO SHOP, &  
TOURNAMENT

RECYCLED  
PLASTICS

SAFETY,  
MAINTENANCE,  
& IRRIGATION

SIGNAGE

RANGE & PRACTICE

TEE AREA

FAIRWAY

GREENS

CLUBHOUSE, PRO SHOP, & TOURNAMENT

RECYCLED PLASTICS

SAFETY MAINTENANCE, & IRRIGATION

**22 GALLON TRASH RECEPTACLES**



22 Gallon GreenWood™ Recycled Plastic Trash. 19"l x 19"w x 43"h

**DDTRASH**

**ARCH DESIGN FLAT TOP TRASH RECEPTACLES**

This great looking trash container includes a 22 gallon trash bin and can have an ash tray added for a nominal upcharge. Many colors and color combinations are available.



**T189FA**  
Arch Design Flat Top Trash Receptacle

**FLAT TOP TRASH RECEPTACLES**

Made from durable GreenWood™ this trash receptacle features the Eagle One "New England" engraved pattern. For easy removal of trash the lid is lifted off allowing access to the enclosed 22 gallon plastic trash bin. Available in Green, Black, Brown, Driftwood and White. These trash receptacles stand 42" high.



**T186FNE**

**PHONE BOXES**

Both styles made from GreenWood™ and mounted on 4" x 4" x 5' posts. Dimensions for the peaked roof boxes are: 12" wide by 10" deep by 14 1/2" high.

Dimensions for the sloped roof boxes are: 12" wide by 10" deep by 18" high. Posts are shipped separately for lower freight costs. Available in: Green, Driftwood, Brown and Black. (Phone not included.)



**T325DP** Peaked Roof  
**T328DP** Sloped Roof





### RECYCLING CENTER

Made with 100% recycled plastic this great looking recycling center is available in a variety of colors. Wide opening accepts a variety of sized trash, bottles and cans.

C470



### "PULL TOP" RECYCLING CENTER

This attractive recycling container is made of 100% GreenWood™ and includes 2 removable 22 gallon bins that lift straight up and out. Color filled engraved wording on the top of each container makes it easy to identify each collection bin. The complete unit is 34" high x 38" wide and is available in Green, Brown, Black, Driftwood and White.

C465



### TRIO RECYCLING CENTER

This unique unit promotes convenience and environmental awareness while offering a traditional look and style. Made of solid GreenWood™, a dual level, podium-like design features a 43" high center receptacle with spring loaded front and back trap doors to contain odors and restrict insects. A hinged back door allows for easy bin removal and a smaller "Pull Top" receptacle flanks each side of the center unit with both containing a firm internal collection bin for easy dumping. Side bins can be easily accessed by lifting off the open hole flat tops.

Three 22 gallon bins are included with this unit and wording can include any arrangement of bottles, cans, trash or custom labeling at your request. Color choices are Green, Brown, Black, Driftwood or White.

C455

SIGNAGE

RANGE &  
PRACTICE

TEE AREA

FAIRWAY

GREENS

CLUBHOUSE,  
PRO SHOP, &  
TOURNAMENT

RECYCLED  
PLASTICS

SAFETY,  
MAINTENANCE,  
& IRRIGATION

SIGNAGE  
RANGE & PRACTICE  
TEE AREA  
FAIRWAY  
GREENS  
CLUBHOUSE, PRO SHOP, & TOURNAMENT  
RECYCLED PLASTICS  
SAFETY, MAINTENANCE, & IRRIGATION

**RUST-OLEUM PAINTS**



Colors available: Black, Blue, Red/Orange, Green, Orange, Red, White, and Yellow



- R260** Rust-Oleum Paint, 12/case
- R240** Traffic Paint, 6/case

- Features a precision-line spray tip for easy-to-read, bright, vivid markings
- Virtually no overspray
- Can be applied down to 25° F (-4° C)
- Dries in less than 5 minutes
- Easy-to-use, spray-through cap guaranteed not to clog
- Marks more linear feet than the competition
- Available as either the standard solvent or as a waterbased paint (special order)
- 12 cans per case

**MARKING WAND AND PISTOL**

- Mark hazards and ground under repair with our accurate, easy-to-use inverted turf marking paint wand.
- Easy to load, easy to shoot and compatible with any brand of marking paint.
- 35" (89cm) long

- R262** Marking Wand
- R263** Marking Pistol
- R243** Turf Chalk



**RUST-OLEUM STRIPING MACHINE**

Made of solid steel construction with a tilt-away handle for easy storage and larger wheel size to roll quickly over turf. Large tray carries 12 cans of paint, allowing you to mark your turf with ease.

- R264** Striping Machine





**PORTABLE RADIO**

Kenwood's compact transceiver, based on a proven design, represents ergonomic excellence. Powerful too: equipped with scan, and built-in VOX, it offers reliable performance in all conditions, thanks to weatherproofing. Indoors or out, rain or shine, the smart new R152 is a star performer!

**COMPACT DESIGN**

The R152's rounded ergonomic contours naturally fit the hand for a superbly comfortable hold, while the non-slip elastomer channel knob with improved torque characteristics ensures positive select operation.

**INTERNAL VOX HANDS FREE READY**

Enjoy the convenience of hands-free operation using any optional headset accessory. The internal VOX (voice-operated transmission) provides PTT control with the simple act of talking. VOX is great for specialized tasks and events where hands-free, constant or repetitive communications are necessary (10-level sensitivity adjustment).

**FUNCTION KEYS**

The two side PF1 and PF2 keys make functions easily available on the R152, with PF1 key for activating the Lock function and PF2 key for Scan w/temp delete function permitting a custom usage for specific users.

**LOCK**

Lock all user controls (except PTT and volume) to prevent accidental channel changes.

**SCAN**

Scanning is a simple way to monitor multiple channels and the R152 (16-channel capacity) offers scan modes.

**VOICE ANNUNCIATION**

When the channel turns and selected other channel, R152 will tell you channel number.

**WIRELESS CLONING**

This wireless feature simplifies the setup of several radios to function identically and eliminates repetitive setup actions of individual radios. (Dealer function only)

**ACCESSORIES INCLUDED**

- 18-Hour Ni-MH with Battery Save Mode On
- 3-Hour Fast Charger
- Spring Action Belt Clip
- Removable Antenna



**R152** - Compact UHF FM  
Portable Programmable Radio



**R152B**  
NI-MH Battery  
Pack (1,500mAh)



**R152BC**  
Belt Clip



**R152M**  
Compact Speaker  
Microphone



**R152C**  
Nylon Case



**R152HS**  
Head Set

**STRIKE ALERT - LIGHTNING DETECTORS**

Help protect your golfers, staff and other visitors from the dangers of lightning strikes. We offer two choices of lightning detection devices which can begin to alert the user of lightning up to 40 miles away giving plenty of time to get to safety. Compact size of both allows for use on golf carts, golf bags, pro-shops, maintenance offices and much more.



The Strike Alert detector is very compact at only the size of a pager. Its special features include impact resistant, belt clip, loud audible warning, 100 hours of operation from one battery, easy to use, economical cost, LED display indicating 0-6, 6-12, 12-24, 24- 40 mile storm distance. Storm approaching / departing indication and variable pitch alert indicating storm distance.

**R004**

SIGNAGE

RANGE &  
PRACTICE

TEE AREA

FAIRWAY

GREENS

CLUBHOUSE,  
PRO SHOP,  
&  
TOURNAMENT

RECYCLED  
PLASTICS

SAFETY,  
MAINTENANCE,  
&  
IRRIGATION

**ANSI APPROVED  
COWBOY SAFETY HELMETS**



Made from durable plastic, these great looking hats allow style and safety to work together. Available in four colors, white, tan, gray and black, and as an added extra, an option to customize with your course logo if desired. Many superintendents comment after purchasing, "Finally, I can get my workers to wear a safety helmet!"

**R102**

**ANSI APPROVED  
SAFARI HATS**



- R104W** Safari Hat - White
- R104WC** Safari Hat - Custom
- R104L** Safari Hat Replacement Head Liner

**HARD HATS**



Available in Green, Blue, Yellow, Red, and White

**R100**

**SAFARI HATS**



Choice of white or beige colors and custom logos if desired.

- R103** Safari Hat
- R103C** Customized Hat

**MESH HELMET**



The mesh material allows for ventilated circulation, keeping the head cool. The adjustable inner hook and loop headband allows for proper sizing (one size fits all). The helmet includes a chin strap for windy days. Available colors include beige or white. A sweatband is included for forehead comfort.

**R107**

**SUN HELMET**



This light weight sun helmet comes complete with replaceable and adjustable liner and sweat band for comfort and a chin strap. They are made from stabilized polypropylene and are not ANSI approved. Tan color only.

**R106**

**ACCESSORIES**

Terry Cloth Sweat Band



Made from quality terry cloth material and fits mesh and plastic sun helmets as well as most hard hats when old sweatbands are removed. Hook and loop fastener for easy removal, and machine washable.

**R106HB**

Sweat Band



**R103SB**

Replacement Headband  
for Safari Hat



**R103HB**

SIGNAGE  
RANGE & PRACTICE  
TEE AREA  
FAIRWAY  
GREENS  
CLUBHOUSE, PRO SHOP, & TOURNAMENT  
RECYCLED PLASTICS  
SAFETY, MAINTENANCE, & IRRIGATION

**SUNSCREEN**



OSHA makes it the responsibility of all employers to protect their employees from all known hazards. Ultraviolet rays are considered a known hazard and is becoming a bigger liability issue daily. For very little expense you can now buy some insurance against this concern. Using a small wall dispenser to dispense our SPF 30 industrial sunscreen, you fulfill your responsibilities and put the onus on the employee. One bladder of sunscreen is 16.9 fl. oz. and supplies approximately 600 average daily uses for one man.

- R780D** Dispenser with refill
- R780R** Refill Bladder

**RESPIRATORS**



Non toxic particle mask. Lightweight and easy breathing/ speaking. 50/box.  
**R420**



Dust and mist respirator. NIOSH/MSHA approved for dusts and mists. Soft and lightweight.  
**R4202200**



EZ-ON™ respirators are the first and only NIOSH approved one strap respirators. N95.

- R420E223** - 10pk  
With valve
- R420E222** - 10pk  
Without valve

**EAR MUFFS**

Independent ear muffs  
These light-weight ear muffs have a Noise Reduction Rating (NRR) of 22 dB(A) when used as directed and meet ANSI Standard 3.19.



**R439**

**EAR PLUGS**



Longer length for easy fitting and removal. Bright green color for compliance checks. NRR 31.

- R4206844**  
250 pairs
- R4206845**  
500 pairs



**R425** - no cord  
Low pressure foam



**R426** - with cord  
Pre-Shaped

**FACE SHIELDS AND GOGGLES**

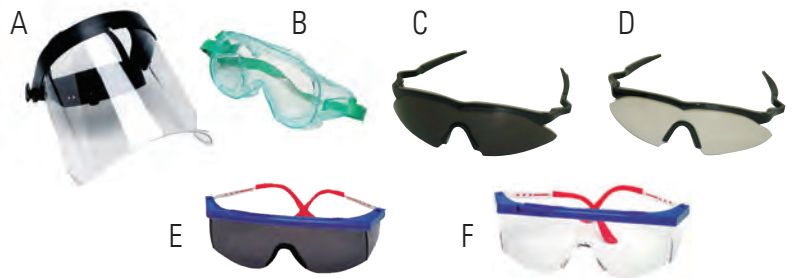

- A. **R429** Full face shield
- R429RS** Full face replacement shield
- B. **R432** Spray goggles
- C. **R434G** Safety glasses - grey nitro
- D. **R434** Safety glasses - clear nitro
- E. **R436G** Safety glasses - nitro
- F. **R436** Safety glasses - clear

**FACE SHIELDS**

Expertly designed six-point suspension system allows head, face and hearing protection in one unit. All components meet new OSHA logging regulations.



**R437**  
Protective Helmet, Visor and Muffs



Brushcutter System  
With steel mesh visor and ear muffs, this system offers excellent face and ear protection while trimming or clearing brush.  
**R438**

SIGNAGE

RANGE &  
PRACTICE

TEE AREA

FAIRWAY

GREENS

CLUBHOUSE,  
PRO SHOP, &  
TOURNAMENT

RECYCLED  
PLASTICS

SAFETY,  
MAINTENANCE,  
& IRRIGATION

SIGNAGE  
RANGE & PRACTICE  
TEE AREA  
FAIRWAY  
GREENS  
CLUBHOUSE, PRO SHOP, & TOURNAMENT  
RECYCLED PLASTICS  
SAFETY, MAINTENANCE, & IRRIGATION

**DISPOSABLE SPRAY SUITS**

Made from S.M.S. fabric, this new and improved coverall is breathable and has increased strength and abrasion resistance.

Size: M, L, XL, and XXL. XXXL and larger available upon special order. Full specifications available upon request.



**R610FH**

Incl. hood, boots, and elastic wrists

**R610CFH**

Case of 25

**R610**

No hood or boots

**R610C**

Case of 25

**STORMFLEX**

These super comfortable rain suits stretch as you move. Triple stitched, available in S - XXL.



**R602J**

Stormflex Jacket

**R602P**

Stormflex Pant

**TINGLEY WEBDRI**

Made in the U.S.A. of PVC/paracril on nylon polyester. The non-woven, high loft fabric is plied in two different directions and then stitch bonded in nylon. This results in dissipating moisture on the inside and giving the fabric an extremely soft hand and shows great stretch qualities. The combination of our unique PVC coating and substrate make the Webdri a truly high performance suit that can withstand heavy laundering and duty. A great value.

Sizes: S, M, L, XL, XXL

**R601J** Jacket

**R6010** Overalls



**HELLY HANSEN RAIN SUIT**

- PVC coated woven polyester - 400g mid weight
- .35 mm
- Chemical and mildew resistant
- Drawcord hood
- 2 hand pockets
- Storm flap with snap closure

Sizes: S, M, L, XL, XXL

**R660J** Jacket

**R6600** Bib/Overall



**TINGLEY HI-TOP OVERSHOES**

One piece injection molded with slip resistant tread known for being the finest brand in the world.

Please specify size when ordering.

Sizes:	S	6 1/2 - 8
	M	8 - 9 1/2
	L	9 1/2 - 11
	XL	11 - 13
	G	13 - 15



**R623**

**TINGLEY GUM BOOTS**

Considered best in its class. Outsole spits out debris providing excellent gripping action without damaging turf. Light and flexible. Please specify size when ordering.

**R622PT**



**GLOVES**

**SHIN GUARDS**



- A. **R418** Economy Spray Gloves
- B. **R417** Nitrile Gloves, 100/pack
- C. **R403** Work Gloves
- D. **R416** Leather Drivers Gloves

Easy-on, easy-off design helps keep pants clean. Washable vinyl outer shell.

**R43180**



**KNEE PADS**



Allegro Economy Non-marking Knee Pad Provide superior protection against impact injuries and discomfort of long hours spent kneeling with comfortable, high quality Deluxe Knee Pad.

**R433**

**R410**  
For Club House

**FIRST AID KITS**

Three kit sizes that provide complete versatility for your course.



**R411**  
Course Marshal  
Cart

**R412**  
For Maintenance  
Facility



**EYE WASH STATIONS**



Contains: 2 16oz. Iso-tone  
1 16oz. Eye Wash Bath  
1 Unit Eye Pads  
1 4" Band-aid  
1 Roll Kerlix.

**R400**



This wall mounted unit provides 15 minutes of continuous flow and is made from durable plastic. The unit is filled with iso-tonic buffered solution.

**R405**

**MEASURING PITCHERS**



- RFJ010** 4oz/100ml Cylinder
- RFJ025** 8oz/250ml Pitcher
- RFJ050** 16oz/500ml Pitcher
- RFJ100** 32oz/1L Pitcher
- RFJ200** 64oz/2L Pitcher
- RFJ500** 128oz/4L Pitcher

These measuring pitchers are made from a food grade polypropylene which is resistant to most agricultural chemicals and are thick walled for strength. These pitchers and cylinders feature excellent pouring control, easy and safe holding, plenty of freeboard for non-spilling and raised measuring graduations in US. Fluid oz. and mls. Custom logos available. Please call for Quote

SIGNAGE

RANGE &  
PRACTICE

TEE AREA

FAIRWAY

GREENS

CLUBHOUSE,  
PRO SHOP, &  
TOURNAMENT

RECYCLED  
PLASTICS

SAFETY,  
MAINTENANCE,  
& IRRIGATION



**MESSAGE HOLDER**

Made of break resistant polycarbonate-like material, the message holder bolts to the front edge of the top of the cart. 81/2" Wide x 8" High

**S311**

**CART ID SIGN**



- Identifies which hole a golfer starts on for shotgun events.
- Sturdy and long lasting. Made of durable 1/4" PVC (can also be nested for ease of storage)
- Sold in sets of 36 pieces (1A-18A and 1B-18B)

**S111120**



**CART IDENTIFICATION FLAGS**

These flags are a simple and effective way to identify your on-course staff. Utilizing a fiberglass stick attached to a heavy duty squeeze clamp a specific flag can be attached to denote "Players Assistant", "Ranger", "Marshal", "U.S. Flag", and "Handicapped".

- ST09800** Ranger
- ST09801** Players Assistant
- ST09802** Handicapped
- ST09803** Marshal
- ST09804** U.S. Flag

**CART DECALS**

Identify your course marshal or assistant. Signs can be selected from either vinyl transfer or plastic board.

PLEASE NOTE: The vinyl transfer is like a sticker. If you are looking for a transferable sign, please order the PVC board.

- S309V** "Marshal" Decal On Vinyl Sticker
- S309P** "Marshal" Decal On PVC
- S310V** "Players Assistance" Decal On Vinyl Sticker
- S310P** "Players Assistance" Decal On PVC



SIGNAGE

RANGE & PRACTICE

TEE AREA

FAIRWAY

GREENS

CLUBHOUSE, PRO SHOP, & TOURNAMENT

RECYCLED PLASTICS

SAFETY, MAINTENANCE, & IRRIGATION

**DIVOT MIX BOTTLES AND  
BOTTLE CONTAINERS**

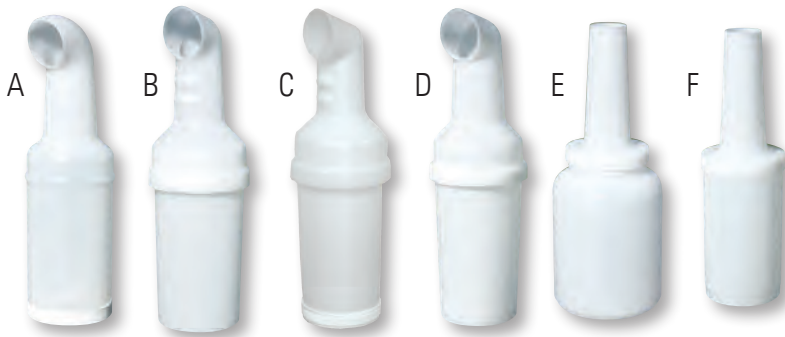

- A - **T312CBF** Bottom-Fill, Curved Neck, 45oz.
- B - **T312CGN** Top-Fill, Curved Neck With Grip, 45oz.
- C - **T312CGNBF** Bottom-Fill, Curved Neck With Grip, 45oz.  
Now With Rattle Proof Feature
- D - **T312C** Top-Fill, Curved Neck, 35oz.
- E - **T312L** Top-Fill, Straight Neck, 64oz.
- F - **T312S** Top-Fill, Straight Neck, 32oz.



**INDIVIDUAL PARTS**



**T312BFRP**  
Bottom-Fill Cap  
Rattle Proof



**T312BFCAP**  
Bottom-Fill Cap



**T312CBKT**  
Club Car Mounting  
Bracket



**T312YBKT**  
Yamaha  
Mounting Bracket

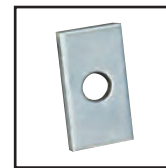

**T312EPLT**  
E-Z-GO  
Mounting Plate

**SAND BOTTLE HOLDERS**

For use with 32, 35 and 45 oz. bottles only.



**T312SCUP**  
Straight Neck  
Bottle Holder



**T312RPCUP**  
"Rattle-Proof  
Holder"



**T312UCUP**  
Universal Holder



**COURTESY CUP**

Back by popular demand! Reduce many problems caused by smokers on your course. The Courtesy Cup drops into the cup holder on your cart.

**C300**



SIGNAGE

RANGE &  
PRACTICE

TEE AREA

FAIRWAY

GREENS

CLUBHOUSE,  
PRO SHOP, &  
TOURNAMENT

RECYCLED  
PLASTICS

SAFETY,  
MAINTENANCE,  
& IRRIGATION



**CONVEX MIRRORS**

For your traffic safety.

- R01118** 18"
- R01126** 26"
- R01136** 36"

**UTILITY CART SEATS**



- Waterproof
- Drain Holes
- Accepts Operator
- Presence Switch
- Accepts Slides
- Black

**E755**

**"SOFTWIPE" SPIKE CLEANER**

Rubber prongs mounted onto an aluminum base allow efficient cleaning of golf cleats. Either cart mounted or used with ground anchors at Tee boxes etc.

- C005** Ground Mounted
- C005C** Cart Mounted per pair
- C005R** Replacement Top



**TIRES**



We offer a wide range of tires at great prices to suit golf cars, lawn mowers, ATV's and other equipment. Brands available include Goodyear, Carlisle, Dico, Titan, Armstrong, BF Goodrich and Nankang. Eagle One has numerous options available. Please talk to a representative for all your golf cart tire needs.

**E100**

**COMBO-WHEEL**



Another option when replacing your cart tire is this time saving choice. This tire comes complete with wheel rim saving you the time/cost of transferring to your existing wheel. Also ideal if you would like to save the expense of tire changing equipment.

**E101TW**

**WHEEL STOPS**

100% Recycled plastic. Very durable and color fast. Fix down with lag bolts or pins.



Please specify concrete or asphalt mount.

- R0204B** 4' Blue
- R0204G** 4' Grey
- R0204Y** 4' Yellow
- R0206B** 6' Blue
- R0206G** 6' Grey
- R0206W** 6' White
- R0206Y** 6' Yellow

SIGNAGE  
RANGE & PRACTICE  
TEE AREA  
FAIRWAY  
GREENS  
CLUBHOUSE, PRO SHOP, & TOURNAMENT  
RECYCLED PLASTICS  
SAFETY, MAINTENANCE, & IRRIGATION



**RUBBER SPEED BUMPS**



These durable speed bumps are made from recycled car tires. They are easy to install and are flexible enough to conform to the surface contour. Mounting hardware included: choice of lag bolts with anchor for concrete, or 12" long nails for asphalt.

- R112** 4' Black
- R113** 6' Black
- R112S** 4' Yellow Stripe
- R113S** 6' Yellow Stripe

**CART GUIDE**



Carts cutting corners and wearing bald spots in the turf is a problem on every golf course. A row of inexpensive Cart Guides can put an end to this problem forever! Cart Guides are the cheapest fix in golfing history. Cart Guides can be easily installed using epoxy pads or screws.

- F0100** Cart Guide
- F0100G** Epoxy Pad



**GOPHER TRAPS**



**R442** Macabee

**LIQUID FENCE**

Liquid Fence® Original Deer & Rabbit Repellent is rain resistant, all natural, biodegradable and environmentally safe. It will not harm the plants or animals and is backed by a written 100% guarantee.



- R7601QT** 1 Quart - Covers 8,000 Sq. Ft.
- R7601GL** 1 Gallon - Covers 32,000 Sq. Ft.



**COYOTE 3D REPLICA**

Life like Coyote provides 360-degree goose repellent coverage, visible from any angle - far superior to flat silhouette coyote cutouts. Rids an area of disease-carrying geese, ducks, seagulls, rabbits, skunks and rodents.

- Safe, humane, and effective
- Works without the use of dangerous chemicals
- Lifelike furry tail changes positions in the slightest breeze

**R74COYOTE3**

SIGNAGE

RANGE &  
PRACTICE

TEE AREA

FAIRWAY

GREENS

CLUBHOUSE,  
PRO SHOP, &  
TOURNAMENT

RECYCLED  
PLASTICS

SAFETY,  
MAINTENANCE,  
& IRRIGATION

**ICE PICK**



**R012**

**COTTON KNIFE**



**R014 - 6"**

**CARPET KNIFE**



**R010**

**LEATHER SCABBARD**



**RC7220**



AN AUTHENTIC AMERICAN BRAND, CORONA TOOLS WERE BORN IN THE ORANGE GROVES OF CALIFORNIA IN THE 1920S. SINCE THEN, GENERATIONS OF AGRICULTURISTS, GARDENERS, LANDSCAPERS, ARBORISTS AND CONSTRUCTION PROFESSIONALS HAVE TURNED TO CORONA FOR HIGH-QUALITY, PERFORMANCE TOOLS THAT WORK AS HARD AS THEY DO. WITH DECADES OF TOOL DESIGN AND INNOVATION, CORONA TOOLS ARE THE PREFERRED CHOICE FOR SKILLED PROFESSIONALS TO THE BUDDING NOVICE.

**MACHETE**



This knife is a top of the line brand, it has an 18" Carbon steel blade, shatterproof, flame resistant handle and thong hole. Other choices available upon special request.

**R013**

**FORGED BYPASS PRUNER 1"**



**RC6250**

**PRUNER 1"**

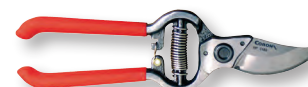

**RC3180**

**TREE PRUNERS**

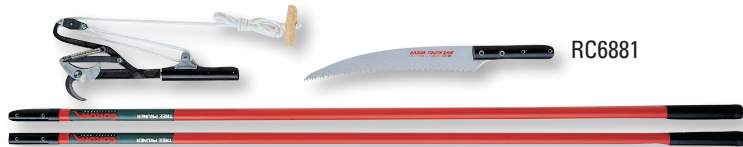

- RC6870** 14" Compound Action Tree Pruner
- RC6881** 12" Arborist Tree Pruning System

**BYPASS LOPPERS**



- RC8240** 26" Aluminum Handle
- RC8260** 32" Aluminum Handle
- RC6361** 26" Wood Handle
- RC6461** 32" Wood Handle

**SAWS**



- RC4050** Folding Pruning Saw
- RC7265** Folding Razor Tooth 10"
- RC7130** Professional Razor Tooth 13"
- RC4081** Razor Tooth 20"
- RC7160** Professional Razor Tooth 21"

**PROFESSIONAL SHEARS**



- RC6750** Grass Shear
- RC6920** Hedge Shear 8" Serrated Blade
- RC6930** Long Handled 8" Hedge Shear
- RC6960** Hedge Shear 10" Blade

SIGNAGE  
RANGE & PRACTICE  
TEE AREA  
FAIRWAY  
GREENS  
CLUBHOUSE, PRO SHOP, & TOURNAMENT  
RECYCLED PLASTICS  
SAFETY, MAINTENANCE, & IRRIGATION

**LEAF RAKES**

**YARD BROOM**

**MONSTER BROOM**



24" Spring Back Rake  
**R452**



19" Leaf Rake  
**R450**



8" Leaf Rake  
**R451**



Heavy Duty  
Yard Broom  
**R460**



- Huge 84" all-aluminum head with two rows of replaceable bristles.
- Quickly removes dew or wormcasts from your greens or tees.
- Use it on the shop floor or tennis court.
- If brushes are too stiff, simply remove one row of bristles to soften.
- 3-piece handle knocks down for shipping.

**ST72150**

**LANDSCAPING AND DIGGING TOOLS**

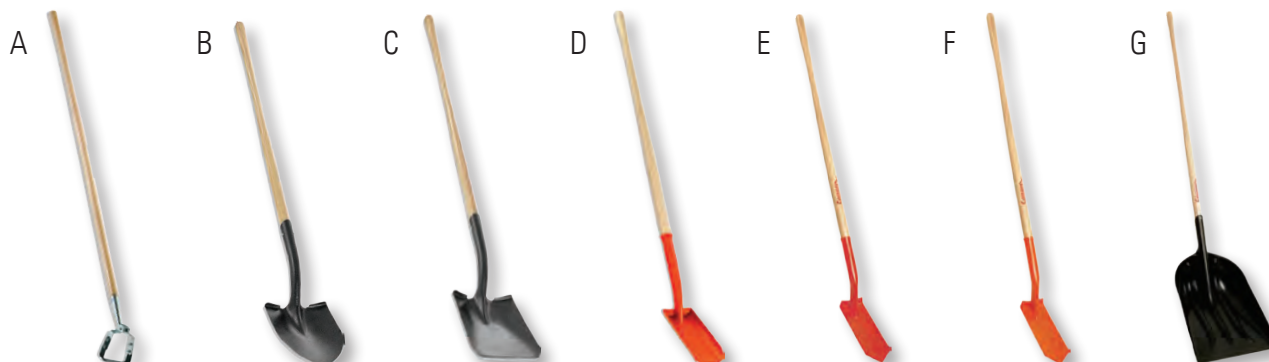

A	<b>R476</b>	Oscillating Hoe - 60" Handle	E	<b>R468W4</b>	Trench General Purpose - 4" Blade, 48" Handle
B	<b>R470WL</b>	#2 Round Pt. Hollow Back - 48" Handle		<b>R468W6</b>	Trench General Purpose - 6" Blade, 48" Handle
	<b>R470WD</b>	#2 Round Pt. Hollow Back - 30" D Grip	F	<b>R469W6</b>	Trench Digging Shovel - 4" Blade, 48" Handle
C	<b>R471WL</b>	#2 Square Pt. Hollow Back - 48" Handle		<b>R469W4</b>	Trench Digging Shovel - 6" Blade, 48" Handle
	<b>R471WD</b>	#2 Square Pt. Hollow Back - 30" D Grip	G	<b>R465PL</b>	12" Plastic Scoop, 48" Handle
D	<b>R467W4</b>	Trench Clean Out Shovel - 4" Blade, 48" Handle		<b>R465P</b>	12" Plastic Scoop, 30" D Grip
	<b>R467W6</b>	Trench Clean Out Shovel - 6" Blade, 48" Handle			



**TUFFY™ SHOVEL**

This unbreakable shovel has a non-stick surface, making it an ideal tool for snow removal. Tuffy's™ non-damaging, rust-proof exterior makes it safe to use on any surface and ideal for aeration plugs.

Blade Length: 14" x 17" x 42"  
D-Grip Handle  
Weight 4 lbs  
LIFETIME WARRANTY  
**R461**



SIGNAGE  
RANGE & PRACTICE  
TEE AREA  
FAIRWAY  
GREENS  
CLUBHOUSE, PRO SHOP, & TOURNAMENT  
RECYCLED PLASTICS  
SAFETY, MAINTENANCE, & IRRIGATION

SIGNAGE  
RANGE & PRACTICE  
TEE AREA  
FAIRWAY  
GREENS  
CLUBHOUSE, PRO SHOP, & TOURNAMENT  
RECYCLED PLASTICS  
SAFETY, MAINTENANCE, & IRRIGATION



**LANDSCAPE KNIFE**

This utility knife is ideal for small trimming work around sprinkler heads etc. It has a serrated blade for more efficient cutting.

**R010S**

**32" REACHER**



Makes it easy for your marshal to reclaim litter on the course.

**R03032**



**TOOL TUB**

This handy organizer is great for all those small tools used out on the course. Twenty six tough fabric pockets line a stiff five gallon bucket, with carry handle, inside and out.

**R008** Tool Tub with bucket

**R008P** Tool Tub pouch only



**TRUCK LINER**

With this rubber matting you can protect many of your tools and equipment from damage and make less noise on your way around the course. 6' x 4' sheets can be easily trimmed to fit snugly in the back of any work-horse vehicle.

**C101**



**ROLATAPE**

**R019** Standard

**R019M** Metric

**SELF CLOSING SAFETY GAS CANS**



These gas cans are made of double-seamed terne plate alloy, they have a built-in relief valve that vents hazardous internal pressure. Protective double mesh integral flame arrester screen, prevents fire from reaching contents of can.

**R1401** 1 Gallon

**R1402** 2 Gallon

**R140F** Funnel

**SPILL-PROOF GAS CANS**



This 2.5 gallon gas can includes a spill proof mechanism for extra safety. It is made from rugged plastic and also prevents leaks of harmful vapors during transportation. Meets California standards.

**R141**

**SPYKER SPREADER**



**LIFETIME WARRANTY**  
All gear systems are guaranteed for the life of a Spyker Spreader.

- 120 lb. (55kg) Poly Hopper Capacity
- One-Piece Welded Stainless Steel Frame
- 5/8" Solid Stainless Steel Axle
- 13" x 5" Pneumatic Tires
- Positive On/Off System
- Enclosed Metal Gears - Lifetime Warranty
- Patented Split-shaft Design for Easy Calibration

S60 Pro Series  
**E30012020**

- 50 lbs. (23 kg) Capacity Poly Hopper
- Powder Coated Frame
- Adjustable Height Handle
- Enclosed Gears
- 10in. x 4in. (254mm x 102mm) Pneumatic Tires
- Positive On/Off (No Cables)
- Includes Screen
- Includes Cover
- Accessories Available for Side and Full Deflection

P20 Pro Series  
**E3005010**

- 175 lbs. (80 kg) Capacity
- Stainless Steel Frame
- Enclosed Metal Gears - Lifetime Warranty
- 13in. x 5in. (330mm x 127mm) Pneumatic Tires
- Positive On/Off (No Cables)
- Accu-way™ Even Spread Pattern Adjustment
- Includes Screen

S30 Pro Series  
**E30017520**

**SPRAYER TANKS**

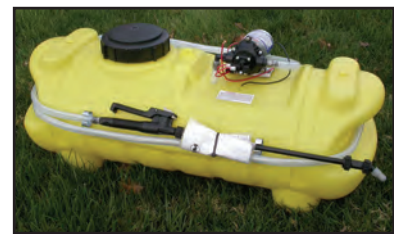

**E675ES14**  
15 Gallon Tank, 12 Volt, Skid Sprayer



**E675ES25**  
25 Gallon Tank, 12 Volt, Turf Sprayer

**"WHEEL SPRAYER" PRECISION APPLICATORS**

These sprayers are motorless and ground-driven not requiring gasoline or batteries for accurate chemical applications of herbicide, fungicide, fertilizer or insecticide. Applications are relatively unchanged by the speed they are pushed. These precision units are the most accurate, trouble-free liquid applicators available.

A. The Grounds Wheelie II is a 6 gallon push sprayer designed for professional grounds maintenance. Equipped with shut-off controls on the handle grips and extra large tires to make pushing easier in tall southern grasses or on hilly, uneven terrain. The twin wheel pumps spray a fan of solution 6' wide, at the rate of 1000 sq. ft. per gallon. The 6 gallon tank-full will cover approximately 6000 sq. ft.

**E675WS485** Grounds Wheelie II

B. This unit is a 10 gallon push type commercial unit featuring the famous Wheel Spray ground-driven pumping system. The pumping system is made of corrosive-resistant materials and is used extensively by golf course professionals on the greens, the collars and around the clubhouse. The 10 gallon tank will cover approximately 10,000 sq. ft. at the rate of 1000 sq. ft. per gallon in a 6' swath.

**E675WS490** Greens Wheelie

C. This 10 gallon push type sprayer features two pumps and two spray nozzles which will deliver a 6' fan of solution at the rate of 1000 sq. ft. per gallon. Extra tanks are available. The shut-off controls, located on the handle grips, allow the operator to use the nozzles independently. This is a very popular feature with turf care professionals.

**E675WS495** Turf Wheelie

D. The 2.5 gallon push Grounds Wheelie sprayer is used to apply liquid fertilizers, herbicides, insecticides, fungicides and growth regulators. The ground-driven pumping system delivers a 36" fan of solution at the rate of 1000 sq. ft. per gallon. This unit is most popular with for use in confined areas near buildings, shrubs, and decorative plantings.

**E675WS250** Lawn Wheelie



A



B



C



D

SIGNAGE

RANGE &  
PRACTICE

TEE AREA

FAIRWAY

GREENS

CLUBHOUSE,  
PRO SHOP, &  
TOURNAMENT

RECYCLED  
PLASTICS

SAFETY,  
MAINTENANCE,  
& IRRIGATION

SIGNAGE  
RANGE & PRACTICE  
TEE AREA  
FAIRWAY  
GREENS  
CLUBHOUSE, PRO SHOP, & TOURNAMENT  
RECYCLED PLASTICS  
SAFETY, MAINTENANCE, & IRRIGATION



**"BYHO" ONE WHEELED EDGER**

This widely used edger, ideal for trimming the bunker lip, features outstanding maneuverability and tight turning radius, rugged and light weight design, heavy duty components and powder coated finish. Available with either a 2.5 HP Honda or 3.5 HP Briggs & Stratton motor. Blade is 12".

- E412H** 2.5 HP Honda Motor
- E412** 3.5 HP Briggs & Stratton Motor

**5LB. SPOOLS**

- A E633095** 1400' x .095'
- E633105** 1150' x .105'
- B E633130** 750' x .130'

**BLADES**

- C E632** Options starting from\*
- D E632S** Star Edger 9"
- E E6327D** Donut Edger 7"
- E6328D** Donut Edger 8"

\*Blade C is available in various sizes and sharpened or unsharpened.

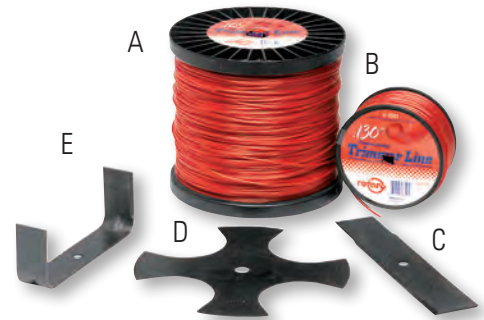

**"EDGIT PRO" TRIMMER GUIDE**

This unique guide device makes accurate trimming a breeze while improving efficiency through quicker job completion times. Attaching to most regular trimmer machines it rolls along the surface as you trim. This provides a super accurate edge at high speed and is also ideal for around bunkers and for horizontal mowing. Other advantages include increased safety, lower surrounding damage, and reduced string consumption. Please indicate the make and model of your trimmer machine when ordering.

**E615**

**TAS HEAD TRIMMER**

Made from heavy duty steel, these head trimmers are fast and efficient. Ideal for sprinkler heads, control valve covers, etc. Sizes span from 33/4" to 101/4" diameters and are designed to fit all major brands of trimmer machines.

- E059TASII** 3.75" Diameter Head
- E05955** 5.5" Diameter Head
- E059TASI** 7" Diameter Head
- E05975** 7.5" Diameter Head
- E059107H** 7.5" Diameter Head (Replacement for Hunter)
- E059GC8** 8" Diameter Head
- E059GC85E** 8.5" Diameter Head
- E059GC10** 10" Diameter Head

\* If installing on Echo equipment, when placing your order please remember that a white spacer is needed.



**"POWERHEAD" SPRINKLER HEAD TRIMMER**



The "Powerhead" device has to be tried to see how well it works. Simply attaching to the base of all major brand grass trimmer machines, it trims sprinkler heads, irrigation boxes and yardage markers in a flash. With no more strings to contend with, the Powerhead will cut hours off your trimming. Please indicate make and model of your trimmer machine. This product comes in four sizes.

- E6356** 6"  
Toro 630/730/760
- E63565** 6.5"  
Hunter/Legacy 520  
Legacy 550/600/650
- E63575** 7.5"  
Toro 650/655/670/780
- E63510** 10"  
Toro 690/Rainbird 91DR  
Rainbird 91DS/10" Valve Box



MARUYAMA MANUFACTURES SUPERIOR QUALITY, PROFESSIONAL OUTDOOR POWER AND CHEMICAL APPLICATION EQUIPMENT. PROFESSIONALS DEPEND ON THEIR EQUIPMENT DAY IN AND DAY OUT AND DEMAND ONLY THE ABSOLUTE BEST...AND THAT'S MARUYAMA

- Powerful and lightweight
- Superior power-to-weight ratio
- 22.5cc Engines
- EPA Compliant
- Fuel efficient
- Professional grade



**EDGER**

**MARBE23**



**TRIMMER**

**MARBT23L**



**POLE PRUNER**

**MARP23-10**

Specifications:	
Engine:	CER230E
Displacement (cc):	22.5
Approx. Weight (lb/kg):	*13.1 / 5.9
Shaft Type:	Flex/curved
Handle Type:	Loop
Starter Assist™:	No
CARB & EPA Compliant:	EPA

Specifications:	
Engine:	CER230E
Displacement (cc):	22.5
Approx. Weight (lb/kg):	11.0/5.0
Shaft Type:	Straight
Handle Type:	Loop
Starter Assist™:	No
CARB & EPA Compliant:	Yes

Specifications:	
Engine:	CER230
Displacement (cc):	22.5cc
Approx. Weight (lb/kg):	12.9 / 5.8
Shaft Type:	7mm solid steel
Handle Type:	Loop w/barrier bar
Bar Length (in/cm):	10 / 25.4
Reach* (in/cm):	74 / 187
Starter Assist™	
CARB & EPA Compliant	
*Reach = Engine case to end of 10" bar	

**HAND-HELD BLOWER**

- Superior balance of output, sound level and weight
- Upright design gives great performance
- Innovative housing design maximizes output and efficiency
- Easy to operate and little effort to start with NO SWEAT™ Recoil Assist Starter System
- External air intake cover included - prevents suction of clothing etc, during use



**MARBL32**

Specifications:			
2-Cycle Engine:	CER300	Air Velocity (mph):	180
Displacement (cc):	30.2	Sound Rating dB(A):	68
Approx. Weight (lb/kg):	9.5 / 4.3	Starter Assist™ standard	
Air Volume (cfm):	450	CARB&EPA Compliant	

**BACKPACK BLOWER**

- Better ergonomic frame design
- Better weight distribution
- Spring-loaded shock-absorbing frame for more comfortable use

**MARBL55**

Specifications:	
Engine Type:	2-cycle
Displacement (cc):	45.4
Approx. Weight (lb/kg):	19.2 / 8.7
Air Volume (cfm):	450
Air Velocity (mph):	190
Sound Rating dB(A):	71
Throttle:	PISTOL
CARB&EPA Compliant	



SIGNAGE  
RANGE & PRACTICE  
TEE AREA  
FAIRWAY  
GREENS  
CLUBHOUSE, PRO SHOP, & TOURNAMENT  
RECYCLED PLASTICS  
SAFETY, MAINTENANCE, & IRRIGATION

**REEL SHARPENING COMPOUND**



Our sharpening compound is pre-mixed to save time, ensure consistent results and reduce wastage. It is formulated from a quality silicon carbide abrasive suspended in our own water soluble carrier, it is non-toxic and harmless to the environment. Compound comes in five grit sizes.

- E55050** 50 Grit Compound
- E55080** 80 Grit Compound
- E550120** 120 Grit Compound
- E550180** 180 Grit Compound
- E550220** 220 Grit Compound

If you like to mix your own, we can supply the gel and grit separately. Please contact your Eagle One Sales Rep for details.

- E550GEL** 3.5 Gallon Gel
- E550GEL5** 5 Gallon Gel
- E55050GRIT** 50 Grit Only
- E55080GRIT** 80 Grit Only
- E550120GRIT** 120 Grit Only

**GOLFCO COMPETITION ROLLERS**

A super tough solid elastomeric precision urethane cast body provides a slick surface that helps eliminate buildup of debris, and with its abrasion resistance is superior to steel.

Non-regreasable sealed ball bearings means no grease, no oil, and no grease fitting maintenance. The exterior sealing (v-ring and shoulder seals) keeps all debris out of the housing. The same overhaul kit fits each and every roller, and all rollers can be rebuilt - typically in less than ten minutes.

The unique and effective "Radius" groove design provides rounded corners on the surfaces in contact with the turf - eliminating gouging and "mushrooming" at the top of the grooves.

All rollers come with a 1 year warranty.

**CABLE SAW**

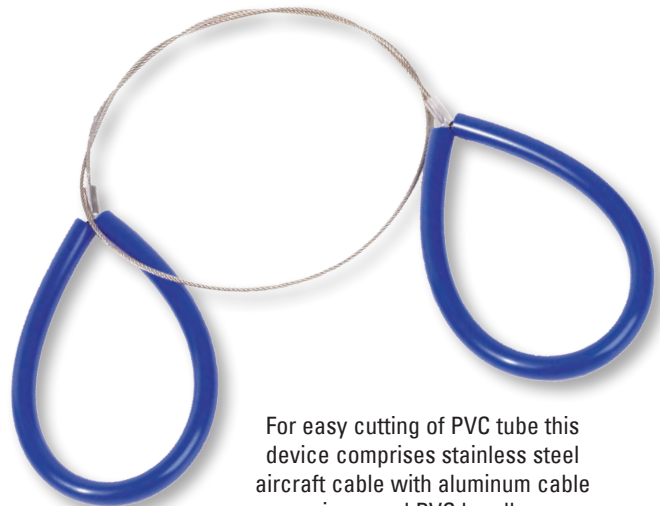

For easy cutting of PVC tube this device comprises stainless steel aircraft cable with aluminum cable crimps and PVC handles.

**109029**



SIGNAGE  
RANGE & PRACTICE  
TEE AREA  
FAIRWAY  
GREENS  
CLUBHOUSE, PRO SHOP, & TOURNAMENT  
RECYCLED PLASTICS  
SAFETY, MAINTENANCE, & IRRIGATION





Don't forget the mounting screws!

**BED KNIVES**

Eagle One is proud to offer a quality bed knife for many of your machines.

Our "Premium" bed knives are clearly a quantum leap in quality. They offer the ultimate cut for your tournament greens while also including a high abrasion resistance for extra long life without sacrificing your reel. If you are serious about quality greens this is a "must have" product.

For prices and applications, please see our Mower Parts And Equipment Catalog or visit [www.eagleonegolf.com](http://www.eagleonegolf.com)



E220AC



**ACCU-GAGE**

This precision tool is used to set accurate height-of-cut adjustments on greensmowers. Incorporating a dial indicator with adjusting bar apparatus highly accurate measurements can be made at the cutting edge of the bed knife. Measurements read as .001" or 01mm, fits all greensmowers.

- E22218** 18" Bar
  - E22218H** 18" Bar Hands Free
  - E22218D** 18" Bar Digital Version
  - E22224** 24" Bar
  - E220AC** Accu-Gage Aluminum Case
- Accu-Gage case only fits Accu-Gage and Groomer Gage

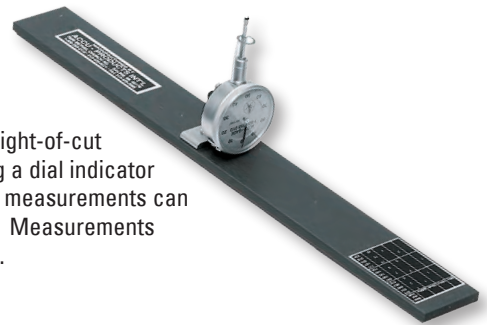

**ACCU-GAGE II**



Hands-Free

**E22218R**  
Accu-Gage  
Recalibration  
Call For Quote



This is similar to "ACCU-GAGE" although it is altered to be used in the field or while units are still attached to mowers.

- E220** Accu-Gage II
- E2201S** Needle Spike 1/4"

**GROOMER GAGE**

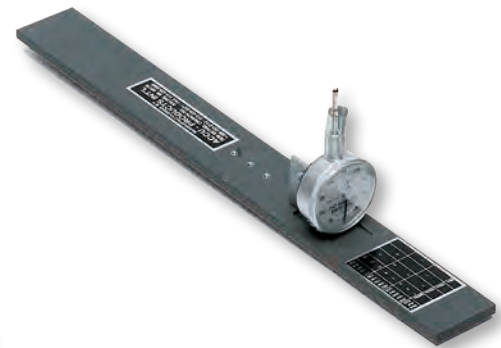

This is a precision measuring instrument for accurately setting the desired grooming depth of groomer or verticutting units.

- E221** Groomer Gage

**ROLLERPRO™**

**PORTABLE SPRINKLER BASE**  
The 22" wide stainless steel roller of RollerPro™ provides a stable field position for supplemental watering. Designed for years of hard use, it is ideal for watering dry spots and newly seeded areas.

Features:

- 22" wide stainless steel roller is weighted to prevent movement during use.
- 3/4" inlet and outlet adapters included
- Standard 1" FHT inlet x 1" female NPT outlet

**I33722RP**

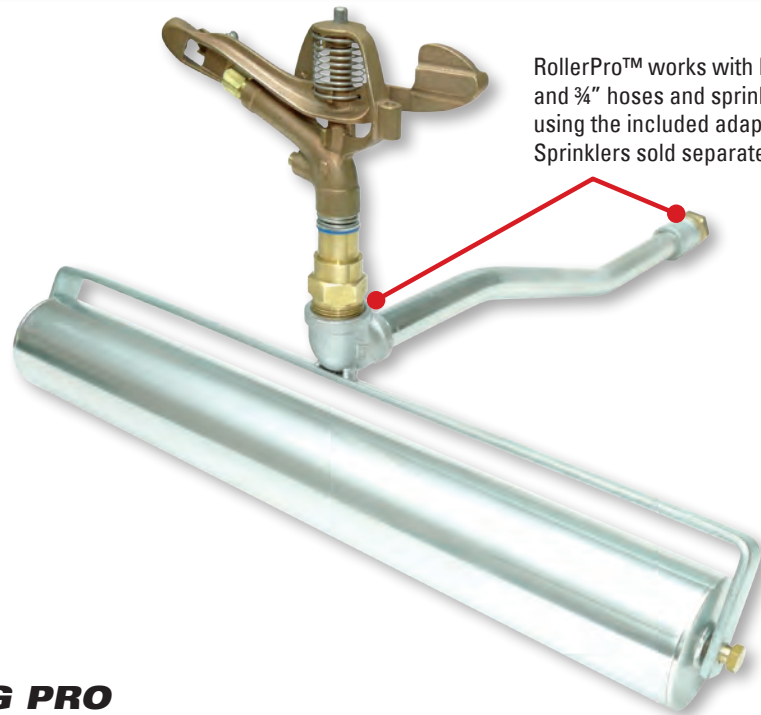

RollerPro™ works with both 1" and 3/4" hoses and sprinklers using the included adapters. Sprinklers sold separately

SIGNAGE

RANGE & PRACTICE

TEE AREA

FAIRWAY

GREENS

CLUBHOUSE, PRO SHOP, & TOURNAMENT

RECYCLED PLASTICS

SAFETY, MAINTENANCE, & IRRIGATION



**WEEDING PRO**

The Weeding Pro allows you to quickly and easily eliminate weeds such as Poa Annual and others without wasteful and costly spraying. With just a push the spring loaded sponge delivers a pre-measured amount of herbicide concentrate and water right where it is needed with no waste. Mix ratio: Cap capacity is 0.2 oz. Tube capacity is 8 oz (40:1)

**I026**

\* Extra Replacement Dauber included with each Weeding Pro



- I026TIP** Replacement Tip
- I026CAP** Replacement Cap



**WETTING FORK™ II**



Using a chrome plated steel construction and three tines, the Wetting Fork II reduces hand-watering time of hydrophobic spots dramatically. Fertilizers, fungicides, wetting agents and insecticides can be injected efficiently into the soil.

- I016** Wetting Fork
- I016RT** Replacement Tines Set of Three

**TURF STRESS DETECTION LENSES**



Now you can identify turf, plant and tree disease up to 10 days before it's visible to the naked eye and you'll look cool doing it! When wearing these lenses from NASA Technology any off color caused by drought, disease or poor nutrition stands out as a glowing red coral or pink making it easy to identify the precise areas in need. Made of lightweight polycarbonate frames they offer a quick change snap in lens system, adjustable nosepiece and a great looking sport style.

**I019**



**ULTRAMAX**



**UltraMAX Valves**

Heavy duty ball valve, push-pull on/off control handle and exceptional build quality for long life under demanding use. Available in Firefighter Grip for two-handed operation or ergonomic Pistol Grip for comfortable, extended use. **NOZZLES SOLD SEPARATELY.**

- I343** 3/4" Fire Fighter Valve
- I343-1** 1" Fire Fighter Valve
- I342** 3/4" Pistol Grip Valve
- I342-1PG** 1" Pistol Grip Valve

**Premium Hose-End Nozzles & Accessories**

Step up to the most professional nozzle you can buy - MAGNUM™ UltraMax. Firefighter quality for professionals in any field, these variable flow, multi-function nozzles are virtually indestructible and leak proof. The innovative TURBO SHIFT models provide two distinct GPM ranges. And the outstanding distribution patterns of all MAGNUM UltraMAX nozzles make them excel in high demand areas like greens/tees, infield conditioning and equipment and stadium washdowns.

- I340** 3/4" Turbo Shift High Flow
- I340-1** 1" Turbo Shift High Flow
- I341** 3/4" Full Throttle High Flow
- I341-1** 1" Full Throttle High Flow
- I340LV** 3/4" Turbo Shift Ultra Flow
- I340LV-1** 1" Turbo Shift Ultra Flow
- I341LV** 3/4" Full Throttle Ultra Flow
- I341LV-1** 1" Full Throttle Ultra Flow

**MAGNUM™**



**SOLID METAL HOSE NOZZLE**

Underhill® Magnum™ contains no plastic internal parts to break, stick or wear out. Our unique ratchet mechanism easily adjusts from gentle fan to powerful jet stream and prevents over-tightening damage. Precision-machined, incredibly smooth operation and outstanding distribution patterns make it ideal for high-demand areas like greens and tees. Magnum™ is also an excellent equipment wash-down nozzle.

- I313** 37GPM@80psi , 3/4" Thread

**Features:**

- Multi-pattern sprays - effortless control with hydraulic assist on/off
- Solid metal internal - no plastic parts to break or wear out
- Ratchet mechanism prevents over-tightening damage
- Ultra-durable construction withstands any abuse
- Fire hose quality nozzle feels great in your hands
- Beautiful, consistent spray patterns for life
- Built for 1" and 3/4" flow rates

**COOLPRO™**



**Cool Without Over Watering - No Root Damage**

A hot summer day can be murder on your greens. Use too much water and you risk damage to the roots. CoolPro™ is the first nozzle specifically designed for the single purpose of lightly misting the turf canopy to cool without over watering. And its 25 foot fogging pattern gets the job done quickly.

- HNCP075** 4GPM@80psi , 3/4" Thread

**Features:**

- Precision™ nozzle fogs at 70 psi to deliver a 25 ft. pattern with only 4-6 GPM
- 3/4" inlet (1" brass adapter available)
- Ergonomic handle/valve provides easy grip and variable on/off control.
- Durable solid metal design: zinc, aircraft aluminum and stainless steel.

SIGNAGE

RANGE &  
PRACTICE

TEE AREA

FAIRWAY

GREENS

CLUBHOUSE,  
PRO SHOP, &  
TOURNAMENT

RECYCLED  
PLASTICS

SAFETY,  
MAINTENANCE,  
& IRRIGATION

**PRECISION™**

Solid metal, specific task hose nozzles  
Underhill® Precision™ nozzles deliver millions of soft, uniform droplets to provide rapid yet surprisingly gentle water application over a huge range of flow rates. From soft watering to powerful drenching, patented Precision nozzles are designed with ideal flow rates and droplet sizes to fully irrigate without disturbing turf, dirt, seeds, etc., providing a precise solution for every hand watering application.



Precision watering for specific tasks



Rainbow™ TASKS: Greens, tees, seed beds, transplants, delicate landscaping

**I31480** 15GPM@80psi  
**I31480K** Nozzle Kit Complete



Rainmaker™ TASKS: Syringe and spot watering turf and hardy landscaping

**I31423** 23GPM@80psi  
**I31423K**



Cloudburst™ TASKS: Dry spots, drenching, and wetting agent application

**I31415** 48GPM@80psi  
**I31415K**



Cyclone™ Pre-game skins watering, heavy watering of large areas, ideal for hydroseeding

**I31450** 50+GPM@80psi  
**I31450K**

**PRECISION™ HOSE ADAPTERS & QUICK-CONNECTORS**



HIGH FLOW CONTROL VALVE BRASS, 3/4"

**I314HF**



3/4" FEMALE x 1" MALE ADAPTER

**I334**



BRASS ADAPTER 1" FHT x 3/4" MHT

**I314BA**



**I314G**

**SWEEPER NOZZLES**



3/4" x 6" BRASS SWEEPER

**I330**



1" x 8" BRASS SWEEPER

**I331**



1" x 2" SWEEPER NOZZLE

**I329**



1" x 1" GREENS SPRAY NOZZLE

**I319**

SIGNAGE  
RANGE & PRACTICE  
TEE AREA  
FAIRWAY  
GREENS  
CLUBHOUSE, PRO SHOP, & TOURNAMENT  
RECYCLED PLASTICS  
SAFETY, MAINTENANCE, & IRRIGATION

**PELLETPRO™**

APPLICATOR GUN FOR SOLID WETTING AGENT TABLETS

Our heavy-duty surfactant applicator, high-flow valve and Precision™ Cloudburst™ nozzle combo comprises the finest wetting agent gun available. PelletPro™ accepts all wetting agent tablets and provides a high volume, yet soft spray for watering or applying surfactants to tight, hydrophobic soils.

Features:

- 35+ GPM to get the job done faster!
- Ultra Heavy-Duty construction: brass fittings, aircraft aluminum, stainless steel, precision engineered glass
- Pellet rotation (1 RPS) evenly dissolves/applies tablets
- Patented Cloudburst™ nozzle delivers large droplets in an outstanding fan pattern



PelletPro™ rotates pellets at one revolution per second (RPS) to evenly dissolve/apply wetting agent

ABS High-Flow 3/4" Valve Full Flow, Oversized Handle  
**I314HFP**

- I314PP** Pellet Pro
- I314PPB** Bowl Only
- I314PPG** Gasket Only



**RAINPRO™**



Tough TPR rubber bumper protects nozzle

SOLID METAL SHOWER NOZZLE

A truly revolutionary shower nozzle for soaking turf or other landscapes...featuring an exclusive solid brass nozzle plate for outstanding pattern and special rubber bumper for nozzle protection.

- I342-1** 1"
- I342-75** 3/4"

Features:

- Ultra durable construction withstands any abuse
- Beautiful, consistent and uniform spray pattern
- Materials: zinc alloy, brass and TPR rubber
- Flow: 40 GPM @ 80psi (built for 1" and 3/4" hose flow rates)
- Nozzle assembly unscrews for easy cleaning

With the included 1" FHT x 3/4" MHT brass adapter, PelletPro™ and LiquidPro™ work with both 3/4" and 1" hoses.

**LIQUIDPRO™**



APPLICATOR GUN FOR LIQUID WETTING AGENT

LiquidPro's chemical-resistant, UV-protected, lightweight siphon/mixing system can cover 1000 square feet in less than a minute! With unmatched speed and uniformity, you can virtually "paint" your turf with liquid wetting agent, fertilizers, and micronutrients. Adjustable metering dial offers 10 additive settings including "Water Only."

With the included 1" FHT x 3/4" MHT brass adapter, PelletPro™ and LiquidPro™ work with both 3/4" and 1" hoses.

**I314LP**

TWO PRODUCTS IN 1!

PelletPro and LiquidPro's Precision™ Cloudburst™ nozzle and high-flow valve quickly assemble to create a powerful, 35+ GPM syringe nozzle.



SIGNAGE  
RANGE & PRACTICE  
TEE AREA  
FAIRWAY  
GREENS  
CLUBHOUSE, PRO SHOP, & TOURNAMENT  
RECYCLED PLASTICS  
SAFETY, MAINTENANCE, & IRRIGATION

SIGNAGE

RANGE & PRACTICE

TEE AREA

FAIRWAY

GREENS

CLUBHOUSE, PRO SHOP, & TOURNAMENT

RECYCLED PLASTICS

SAFETY, MAINTENANCE, & IRRIGATION

**TOURNAMENT-READY®**

PREMIUM PERFORMANCE NONIONIC SOIL SURFACTANT

- University tests confirm Tournament-Ready's comparable performance in side-by-side testing against leading competitive brands\*
- Tournament-Ready uses a blend of three surfactant ingredients to provide flexibility in use as a preventative and curative treatment
- Tournament-Ready delivers rapid wetting of repellent soils, drives down surface moisture to avoid spongy turf and delivers moderate residual for rewetting up to 14 weeks from initial application\*
- Tournament-Ready will eliminate localized dry spot, provide more uniform wetting action, and enhance water's infiltration and drainage



2.5 Gal / 9.48 L / 2 per case

**IUHTUR02**

**TOURNAMENT-READY® PELLETS**

PROVEN TOURNAMENT-READY FORMULA IN SOLID PELLETT FORM

- Same University tested formula in solid pellet for supplemental treatments
- Treat small turf areas while hand watering using Underhill PelletPro applicator
- Inert binder is carrier for Tournament-Ready Soil Surfactant for metered hand watering application
- Tournament-Ready Pellets help cool canopy temperatures of turfgrass during high heat, stress conditions
- Pellet jar can be inserted in pellet applicator reservoir to modulate soil surfactant output



6oz./170gm pellet  
24 pellets per case

**IUHTUR265**

**H2O MAXIMIZER™**

NONIONIC SOIL SURFACTANT, POLYMER RESIN BLEND

- Unique soil surfactant and polymer resin blend that can be tank mixed for spray application or injected directly into irrigation flow
- Surfactant ingredients provide initial soil wetting action while polymer resin adsorbs to soil particles for enhanced water retention
- Reduced watering requirements are achieved through surfactant's reduction of surface tension combined with polymer resin's attachment to soil particles for greater water holding capacity to guard against plant stress
- Polymer resin boosts water retention in soil to deliver enhanced residual activity



2.5 Gal / 9.48 L / 2 per case

**IUHHMAX02**

**HYDRO-WET® PREMIUM PELLETS**

CONCENTRATED HYDRO-WET IN SOLID PELLETT FORM

- Same University tested Hydro-Wet formula in solid pellet for supplemental treatments while hand watering turf areas
- Hydro-Wet Pellets help cool canopy temperatures of turfgrass during high heat, stress conditions
- Apply with PelletPro Applicator



6oz./170gm pellet  
24 pellets per case

**IHYPEL-6**

**MEDALIST®**

ECONOMICAL NONIONIC SOIL SURFACTANT BLEND FOR SEASON-LONG APPLICATIONS

- Medalist, when used in a scheduled, water management program, will eliminate turf localized dry spot and enhance turf quality while reducing watering frequency
- Ideal for suppression of dew and moisture
- Medalist's lower active formula incorporates the same university tested ingredients found in Tournament-Ready Soil Surfactant to deliver comparable performance to leading competitive products at a reduced price
- Medalist can be applied using the LiquidPro or boom sprayer
- Season long application of Medalist will improve soil moisture content to lower watering costs while maintaining turf quality



2.5 Gal / 9.48 L / 2 per case

**IMED02**

**HYDRO-WET® INJECTABLE**

NONIONIC SOIL AND TURF WETTING AGENT FOR IRRIGATION INJECTION

- Hydro-Wet Injectable improves infiltration and penetration of rainfall and irrigation water
- Minimizes water loss due to run-off and evaporation
- Formulated for use with irrigation system metering equipment
- Hydro-Wet's high affinity for water drives down surface moisture to avoid spongy turf and standing water
- When university tested in comparison to 10 leading competitors, Hydro-Wet provided superior performance at reducing soil repellency \*



30 Gal / 114 L drum

**IUHHY130**

**BIO-90™**

NONIONIC SURFACTANT / TANK MIX ADJUVANT

- Use Bio-90 when accompanying pesticide label instructions recommend the use of a nonionic surfactant tank mix adjuvant
- Bio-90 optimizes the performance of turf fungicides, insecticides and herbicides
- Use Bio-90 when uniform spray coverage and penetration into the targeted plant surface is preferred
- Bio-90 contains rainfast ingredient to minimize wash-off
- Bio-90 contains an antifoam ingredient to suppress troublesome foam during agitation



1 Qt / 946ml jug / 12 per case

**IB1901Q**

**CADENCE™**

NONIONIC ORGANOSILOXANE / SPREADER / PENETRANT BLEND

- Cadence is a low use rate, spreader-activator tank mix adjuvant that significantly improves the performance of pesticide and fertilizer spray applications
- Use Cadence when the accompanying pesticide label instructions recommend the use of a nonionic surfactant
- Cadence's super spreading action is the result of reducing surface tension dramatically lower than traditional nonionic surfactant adjuvants
- Unlike conventional surfactants, Cadence rapidly covers and penetrates waxy plant surfaces to allow larger amounts of active ingredient to enter the plant
- Cadence works as a dew control agent for turf and as a mulch, peat or potting soil surfactant



1 Qt / 946ml jug / 6 per case

**ICADEN1Q**

SIGNAGE

RANGE &  
PRACTICE

TEE AREA

FAIRWAY

GREENS

CLUBHOUSE,  
PRO SHOP, &  
TOURNAMENT

RECYCLED  
PLASTICS

SAFETY,  
MAINTENANCE,  
& IRRIGATION

**WATER FX™**

DRY WATER CONDITIONER / ACIDIFYING AGENT ADJUVANT

- Water FX effectively sequesters hard water minerals such as calcium, magnesium and iron that can interfere with many pesticide active ingredients
- Water FX lowers spray water pH to ensure full effectiveness of many insecticides, fungicides and herbicide sprays that perform better in moderately acidic water
- Certain pesticide active ingredients will be more effective and are more readily available to the plant with the use of Water FX



4 lb / 1.8kg jar / 6 per case

**IWFX04**

**ANTI-FOAM™**

ANTIFOAMING AND DEFOAMING AGENT

- Anti-Foam is a fast, effective defoamer for use in suppressing foam Controlling foam reduces filling time and lessens overflow waste
- Anti-Foam improves spray performance
- Silicone and surfactant blend work in tandem to quickly dissipate troublesome foam that forms during agitation



1 Qt / 946 ml bottle / 12 per case

**IAF10**

**K-KLEAN™**

LIQUID TANK CLEANER

- K-Klean is an effective cleaner for metal, fiberglass and plastic spray systems
- K-Klean aids in the removal of dirt, grime, grease, chemical and fertilizer residues from tanks and equipment
- K-Klean helps eliminate rust and scale and keeps costly equipment in ready-to-use condition



1 Gal / 3.79 L jug / 4 per case

**IKKEAN01**

**TANK CLEANER™**

DRY TANK & EQUIPMENT CLEANER

- Tank Cleaner is designed for cleaning tanks, lines and nozzles to remove pesticide, herbicide and fertilizer residues
- Tank Cleaner also removes light rust and dissolves deposit buildups while leaving a protective film that helps prevent corrosion
- Color dye in Tank Cleaner indicates ingredients are still active in solution



1 lb / 456 gm jar / 12 per case

**ITC01**

**BENCHMARK™**

ALL SEASON FOAM MARKER

- This foam concentrate is specially formulated to deliver long lasting foam in a range of weather and field conditions
- This highly concentrated formula, when used as directed will produce thick, white, highly visible foam. Benchmark can be used with any compressed air foam marking equipment to provide long lasting foam deposits on turf or soil areas to avoid over-sprays or skips
- Benchmark is formulated with conditioners for hard water situations and can be used with foam colorants



1 Gal / 3.79 L jug  
4 per case

**IBMK01**

SIGNAGE  
RANGE & PRACTICE  
TEE AREA  
FAIRWAY  
GREENS  
CLUBHOUSE, PRO SHOP, & TOURNAMENT  
RECYCLED PLASTICS  
SAFETY, MAINTENANCE, & IRRIGATION



**DRAINBLASTER™**

**HIGH PRESSURE DRAIN CLEANING NOZZLE**

This unique hose-end, high pressure nozzle guides itself in cleaning out drains, to remove debris with ease. Special feature includes a wire attachment connector for using wire locator to determine drain route.

Features:

- Front jet cuts through blockage
- Rear jets propel nozzle upline
- Two stage flushing action
- Minimum water pressure: 70 PSI
- Heat treated grade 303 stainless steel for long life

- I344-1** 1"
- I344-75** 3/4"

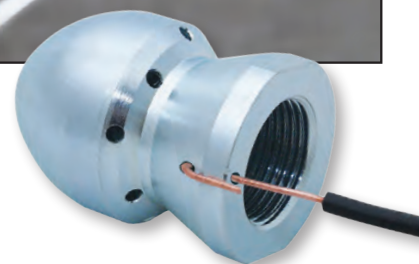
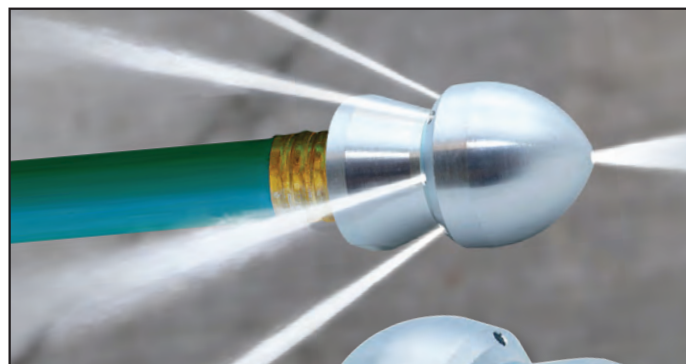

Wire attachment connector for mapping drain location under greens, bunkers and other locations using a wire locator.



Great for cleaning under sidewalks or cart paths    Ideal for 4"-6" drains and catch basins

**HIGH-FLOW VALVES**



COMPOSITE / STAINLESS STEEL:  
3/4" hose thread inlet/outlet,  
oversized handle, up to 55 GPM

SOLID BRASS: 3/4" hose thread  
inlet/outlet, up to 50 GPM

**I314PA**

**TRIGGER NOZZLE**



**I318**

**ALL PURPOSE NOZZLE**

This nozzle is made of high strength plastic and is fully adjustable for fine wide spray to narrow direct to off position. Two sizes. 3/4" and 1".

- I3161** Hose Fit 1" All Purpose Nozzle
- I3163/4** Hose Fit 3/4" All Purpose Nozzle



SIGNAGE  
RANGE & PRACTICE  
TEE AREA  
FAIRWAY  
GREENS  
CLUBHOUSE, PRO SHOP, & TOURNAMENT  
RECYCLED PLASTICS  
SAFETY, MAINTENANCE, & IRRIGATION

**QUICK COUPLER VALVES & KEYS**

**SOLID BRASS, SINGLE SLOT/LUG ESSENTIALS**

Built to last, Underhill® valves and keys are constructed of solid red brass and stainless steel. Valves incorporate rugged one-piece design.

VALVES				KEYS				APPLICATION		
VALVE SKU	INLET	LUG	PC	KEY SKU	MALE	FEMALE	LUG	BUCKNER	RAINBIRD	TORO
I46133	3/4"	DBL	2	I46333	3/4"	1/2"	SGL	QB33K07	33DK	463-01
I4613	3/4"	DBL	1							
I46144	1"	SGL	2	I46344	1"	3/4"	SGL	QB44K10	44K	464-01
I46144	1"	SGL	2	I463100	1"	3/4"	SGL	QC100	44K	464-01
I46144AT	1"	ACME	2	I46344AT	1"	3/4"	ACME	QB44KAT10	4K-ACME	464-03
I4615	1"	DBL	1	I46355	1"	3/4"	DBL	QB55K10	-	-
I4615	1"	DBL	1	I463101	1"	3/4"	SGL	QC101	55K-1	465-01
I4615RK	1"	DBL	1	I46355RK	1"	-	SGL	QB5RK10	55K-1	465-01
I4615	1"	DBL	1	I463101S	1 1/4"	1"	SGL	QCS101	55K-1	465-02
I4617	1 1/4"	DBL	1	I4637	1 1/4"	1"	DBL	QB7DK15	-	-
I4619	1 1/2"	SGL	1	I463151	1 1/2"	1 1/4"	SGL	QC151	7K	466-01

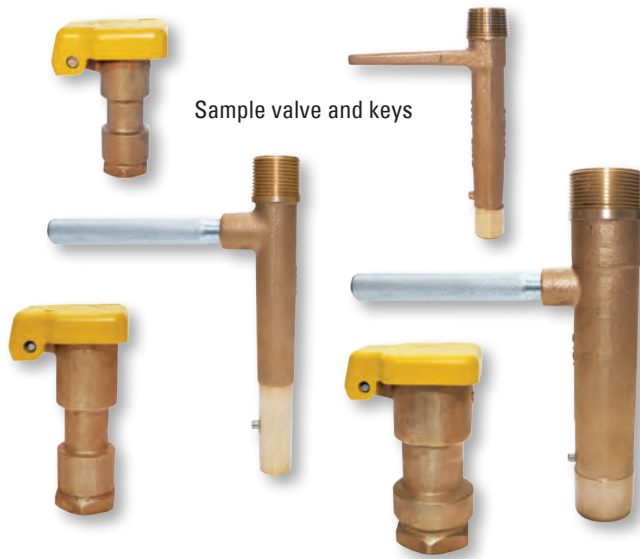

Sample valve and keys



**THE CLAW™**

The Claw™ pictured with 1" quick coupler, key and hose swivel.

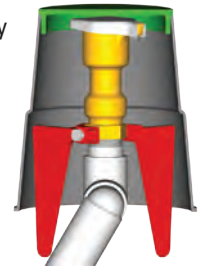

**EASY RETROFIT!**  
Installs without removing valve or valve box!

**HOSE SWIVELS**

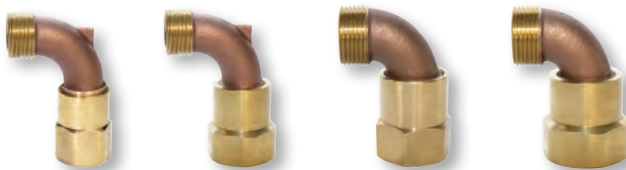

- I46475** Hose Swivel 3/4" x 3/4"
- I464100** Hose Swivel 1" x 3/4"
- I464101** Hose Swivel 1" x 1"
- I464125** Hose Swivel 1 1/4" x 1"

**QUICK COUPLER MOTION RESTRAINT**

When quick coupler valves become unscrewed from swing joints, it's more than just a hassle - it can be dangerous. The Claw™, new from Underhill®, offers a simple solution. Embedded in the soil below the quick coupler, and then securely attached to its base, The Claw provides significant resistance to rotational, vertical and horizontal motion, preventing the valve from moving. Made from high strength ductile iron, this compact anchor attaches easily with a single steel bolt.

- I314150** 1.5"
- I314751** 3/4"

SIGNAGE  
RANGE & PRACTICE  
TEE AREA  
FAIRWAY  
GREENS  
CLUBHOUSE, PRO SHOP, & TOURNAMENT  
RECYCLED PLASTICS  
SAFETY, MAINTENANCE, & IRRIGATION

**IMPACT SPRINKLERS**

**SOLID BRASS, ULTRA-RELIABLE WORKHORSES**

For reliable, trouble-free, high-performance year after year, you just can't beat our brass impact sprinklers. Available in full circle and full/part circle, in inlet sizes of 3/4", 1" and 1 1/4".

**Features:**

- Solid brass construction
- Stainless steel drive spring
- Bearing assembly hood for longer wear life
- Chemical resistant bearing seals
- Solid brass nozzle



**I46590**

Impact Sprinkler 1/2"  
Full or partial circle.  
Pressure: 25-55 PSI  
Flow: 2.79-7.34 GPM  
Spacing: 33-40 Feet

**I4652001**

Impact Sprinkler 3/4"  
Full Circle  
Pressure: 35-80 PSI  
Flow: 2.52-15.71 GPM  
Spacing: 40-62 Feet

**I465261**

Impact Sprinkler 3/4"  
Full or partial circle.  
Pressure: 30-60 PSI  
Flow: 3.94-13.73 GPM  
Spacing: 41-50 Feet

**I465350**

Impact Sprinkler 1"  
Full circle  
Pressure: 40-80 PSI  
Flow: 14.61-46.59 GPM  
Spacing: 47-80 Feet

**I465360**

Impact Sprinkler 1"  
Full or partial circle  
Pressure: 35-80 PSI  
Flow: 7.75-35.36 GPM  
Spacing: 49-77 Feet

**HOSETAP™**



Toro

Rain Bird

**SOLID METAL HOSE ADAPTER**

HoseTap™ gives you a hose connection anywhere you have a Toro® or Rain Bird® electric, valve-in-head sprinkler... a fast connection when quick-couplers or hose bibs are not available. Includes aircraft aluminum body (won't break or wear out like plastic) anodized with sprinkler manufacturer color, o-ring, riser, 1" brass swivel and 3/4" adapter. Also available without brass swivel/adapter.

- HNT100S** Toro 1"
- HNT150S** Toro 1.5"
- HNR125S** Rain Bird 1"
- HNR150S** Rain Bird 1.5"



**HOSETAP ADAPTER™**

All metal adapter, no plastic to break. Transforms your Toro or Rain Bird electric valve-in-head sprinklers into a HoseTap. Ideal for quick connection when quick-coupler or hose bid is not available. Made of long life anodized aircraft aluminum and color coded for easy sprinkler manufacturer identification, includes disc, o-ring, and riser (nipple)...brass swivel sold separately.

**HNT100**

HoseTap Adapter, with riser (nipple) 1" NPT threads, fits all Toro 1" inlet golf sprinklers. 630, 660, 730, 760, 830 and 860 series



**HNT150**

HoseTap Adapter, with riser (nipple) 1" NPT threads, fits all Toro 1 1/2" inlet golf sprinklers... 650, 670, 680, 750, 780, 850 and 880 series



**HNR125**

HoseTap Adapter, With riser (nipple) 1" NPT threads, fits all Rain Bird Eagle 700 series golf sprinklers



Hose Tap for Rain Bird Eagle 900 series available

SIGNAGE

RANGE & PRACTICE

TEE AREA

FAIRWAY

GREENS

CLUBHOUSE, PRO SHOP, & TOURNAMENT

RECYCLED PLASTICS

SAFETY, MAINTENANCE, & IRRIGATION



**PROLOCKER™**

Kit includes:

- Entire Precision™ nozzle series and brass high-flow valve
- CoolPro™ fogging nozzle
- Magnum™ UltraMax nozzle
- PelletPro™ wetting agent applicator

- SuperKey XL™ golf sprinkler multi-tool
- Gulp™ UltraMax syringe pump
- Gulp™ UltraMax pump
- TurfSpy™ stress detection glasses
- HeadChecker™ nozzle discharge pressure gauge, flex hose and pitot tub

THE MOST POPULAR ASSORTMENT ALL-IN-ONE COMPLETE KIT  
Keep all of your Underhill® professional watering tools secure and safe in this handy kit. ProLocker attaches easily to any utility vehicle for easy access. Case is ultra-durable, made of high-strength composite material and is lockable.

IPL



**NOZZLELOCKER™**

THE VERY BEST NOZZLES  
KEEP THEM SECURE (and handy)

Kit includes:

- Entire Precision™ nozzle series (Rainbow™, Rainmaker™, Cloudburst™ and Cyclone™)
- Solid Brass High-Flow Valve
- CoolPro™ with Precision™ fogging nozzle
- Your choice of MAGNUM™ multi-pattern nozzle (original, UltraMAX Turbo Shift, or UltraMAX Full Throttle)
- Unbreakable, lockable, corrosion-proof case to keep these tools safe and secure

IHP

SIGNAGE  
RANGE & PRACTICE  
TEE AREA  
FAIRWAY  
GREENS  
CLUBHOUSE, PRO SHOP, & TOURNAMENT  
RECYCLED PLASTICS  
SAFETY, MAINTENANCE, & IRRIGATION

PROFILE NOZZLES FOR **TORO®**

730 SERIES Full Circle: Front/Rear Nozzle Set

- IT730-3313** #33 Brown/#13 Gray
- IT730-3413** #34 Blue/#13 Gray
- IT730-3515** #35 Violet/#15 Red
- IT730-3515L** #35 Green/#15 Red\*
- IT730-3615** #36 Red/#15 Red\*
- IT730-3617** #36 Red/#17 Lavender

\* For square spacing, specify #17 (lavender) nozzle with the #35 and #36 range nozzles

760 and 860 SERIES Part Circle: Midrange/Close-in Nozzle Set

- IT760-GY** 760 Gray/Yellow
- IT860-GY** 860 Gray/Yellow

830, 834S, DT SERIES Full Circle: Midrange/Close-in Nozzle Set

- IT830-GY** 830 Gray/Yellow
- IT834-GY** 834S Gray/Yellow

835S SERIES Full Circle: Midrange/Close-in Nozzle Set

- IT835S-WP** 835S White/Plug

630 SERIES CALL FOR AVAILABILITY



PROFILE NOZZLES FOR **RAIN BIRD®**

EAGLE 700 SERIES

- IR70028-RG** #28 & Close In/Gray
- IR70032-RG** #32 & Close In/Gray
- IR7003640-GG** #36 & #40 & Close In/Gray

Profile nozzles are so consistent, with distribution patterns so uniform... it's like rain on demand.™

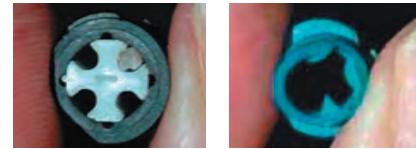

LOOK FAMILIAR? Poor performing Eagle 700 sprinklers are often the result of clogged and worn nozzles. Profile nozzles' solid metal construction and nozzle shape were scientifically designed to solve this exact problem. They simply don't wear out. And they don't clog. Upgrade your old golf sprinklers to better than OEM with Profile!



900 EAGLE SERIES

- IR900-M** 900 Maroon

91 SERIES BRASS IMPACTS

- IR91-G** 991 Gray

51 SERIES BRASS IMPACTS

Full Circle: Front/Rear Nozzles

- IR51-1411.5** 51 #14 White/#11.5 Gray
- IR51-1611.5** 51 #16 Blue/#11.5 Gray
- IR51-1811.5** 51 #18 Yellow/#11.5 Gray
- IR51-2011.5** 51 #20 Red/#11.5 Gray
- IR51-2213** 51 #22 Green/#13 Black
- IR51-2413** 51 #24 Black/#13 Black



670 SERIES Full Circle: Rear Nozzles

- IT670-BY** 670 Black/Yellow

690 SERIES Full Circle: Rear Nozzle

- IT690-G** 690 Gray

750 SERIES Full Circle: Front/Rear Nozzle Set

- IT750-5617** 750 #56 Red/#17 Lavender
- IT750-5717** 750 #57 Gray/#17 Lavender

780, 854S, DT SERIES Midrange/Close-in Nozzle Set

- IT780-BY** 780 Black/Yellow
- IT854-BY** 854S Black/Yellow
- ITDT100-GY** DT100 Black/Yellow
- ITDT150-BY** DT150 Black/Yellow

855S SERIES Full Circle: Midrange/Close-in Nozzle Set

- IT855S-PP** 855S Pink/Plug

650 SERIES CALL FOR AVAILABILITY



All original equipment manufacturers, names and products presented in this publication are used for identification purposes only, and we are in no way implying that any of our products are original equipment parts. Toro® is a registered trademark of the Toro Company, Rain Bird® is a registered trademark of the Rain Bird Sprinkler Manufacturing Corporation.

SIGNAGE

RANGE &  
PRACTICE

TEE AREA

FAIRWAY

GREENS

CLUBHOUSE,  
PRO SHOP,  
& TOURNAMENT

RECYCLED  
PLASTICS

SAFETY,  
MAINTENANCE,  
& IRRIGATION

SIGNAGE  
RANGE & PRACTICE  
TEE AREA  
FAIRWAY  
GREENS  
CLUBHOUSE, PRO SHOP, & TOURNAMENT  
RECYCLED PLASTICS  
SAFETY, MAINTENANCE, & IRRIGATION



**SUPERKEY XL™**

MULTI-PURPOSE TOOL FOR TORO, RAINBIRD GOLF SPRINKLERS

The ultimate all-in-one tool for your golf sprinklers...think of it as a Swiss army knife, a must have companion. Made of stainless steel and composite material, it effortlessly turns electric valve-in-heads on and off, removes internal snap rings and performs many other sprinkler maintenance chores. Great for John Deere®/Signature® sprinklers, too!

**I050SK**

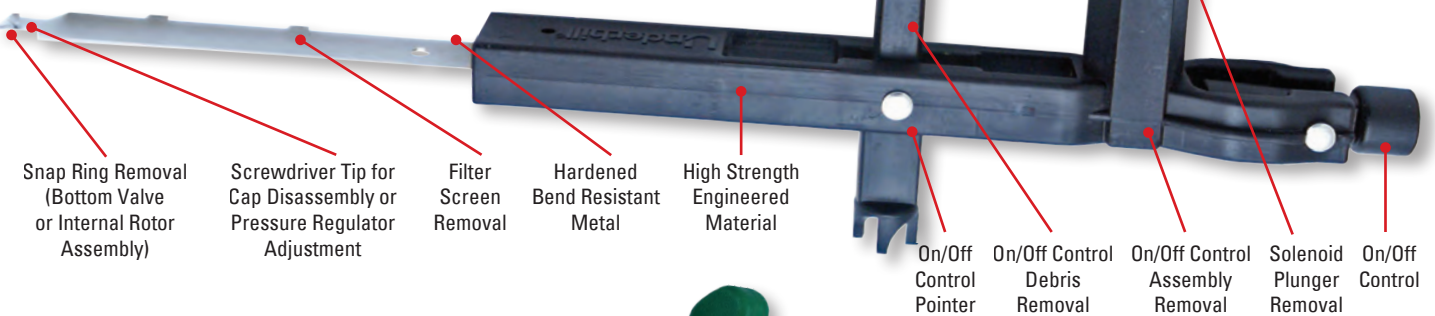

Snap Ring Removal (Bottom Valve or Internal Rotor Assembly)

Screwdriver Tip for Cap Disassembly or Pressure Regulator Adjustment

Filter Screen Removal

Hardened Bend Resistant Metal

High Strength Engineered Material

On/Off Control Pointer

On/Off Control Debris Removal

On/Off Control Assembly Removal

Solenoid Plunger Removal

On/Off Control

**EASYREACH™ KEY**

EXTRA-LONG SHAFT ON/OFF KEY

Extra long and extra heavy duty metal key designed for easy on/off operation for TORO, Rain Bird and John Deere/Signature electric valve-in-head golf sprinklers. Made of high grade metal, EasyReach offers years of effortless on/off operation.



**I050ERRK** Rain Bird

**I050ERTK** Toro

**VERSALID™**

VALVE BOX UNIVERSAL REPLACEMENT LID

VersaLid™ is the easy solution for broken or missing valve box lids. No need to guess what brand a buried box is or even worse - dig it up to find out - VersaLid's locking system fits all 6"-7" round valve boxes.

**I314VL6**

Features:

- Fits all 6"-7" round boxes
- Universal fit
- Greater top-load strength and more UV-resistant than structural foam lids
- PURPLE LID AVAILABLE FOR NON-POTABLE/RECLAIMED WATER



**SPLICE KIT**

3M DIRECT BURY SPLICE KIT

Each kit includes one wire connector which accommodates wire sizes from 18-10 gauge and a waterproof gel case. Excellent for golf, commercial and residential applications.

**I314SK**



**I314VL6P**



### 2" TURF PLUGGER

Ideal for replacing small areas of damaged turf. Tube handle can be filled with plugs from any nursery area. New plugs emerge from the top of the tube as damaged plugs are cut. Simply replace damaged plug with fresh plug from the top of the tube. Adjustable blade for plugs up to 4" (10cm) deep. Zinc plated steel construction.

ST29475



## GULP™ ULTRAMAX

SUPER HIGH-CAPACITY WATER  
REMOVAL SUCTION PUMPS

Whether you need to remove water from sprinklers and valve boxes or other areas or devices, UltraMax Series Pumps are the ideal tools for the job...huge capacities and the smoothest pumps you will ever use as well.

Special features:

- Super Smooth Pumping Action
- High Volume Capacity
- Strong Aluminum Pump Shaft
- Contour Grip Handle
- No Leak Seals
- Self Priming

### BIG GULP ULTRAMAX

- 35 oz./stroke
- 36" pump chamber
- 72" or 36" outlet hose

1071



### GULP ULTRAMAX

- 18 oz./stroke
- 14" clear pump chamber
- 18" outlet hose

1008



Easy,  
push-button  
cleaning  
system

### GULP SYRINGE ULTRA

- 12 oz./stroke
- 12" pump chamber

1006



Gulp UltraMAX and BigGulp UltraMAX include debris filter attachment for very dirty water.



Also great for:



## SUCTION PUMP

Length: 12"  
Hose: 8"

Versatile hand-pump with a quick-clean discharge. Ideal and easy to carry on maintenance carts for dewatering sprinkler heads.

1069S



## WATER PUMP

Length: 36"  
Hose: 72"

Just four strokes quickly pump a gallon of water from valve boxes, sprinklers and other wet areas. Heavy-duty, corrosion proof, self-priming, easy cleaning.

1070

HEAVY DUTY Water Removal Suction Pump



SIGNAGE

RANGE &  
PRACTICE

TEE AREA

FAIRWAY

GREENS

CLUBHOUSE,  
PRO SHOP, &  
TOURNAMENT

RECYCLED  
PLASTICS

SAFETY,  
MAINTENANCE,  
& IRRIGATION

SIGNAGE  
RANGE & PRACTICE  
TEE AREA  
FAIRWAY  
GREENS  
CLUBHOUSE, PRO SHOP, & TOURNAMENT  
RECYCLED PLASTICS  
SAFETY, MAINTENANCE, & IRRIGATION



**MOISTURE SENSOR**

A quick and convenient way to monitor moisture on golf greens, tees and turf grass areas. Calibrated in percentages. Read-outs are immediate. 1" to 4" depths.

**I008**



**PH METER**

Check your PH in soil horizons from 1" to 6" deep. Monitor soil reaction yourself. Gives readings from 3.5 to 9. Proper PH analysis will allow the maximum amount of nutrients to reach grass plant. Read-out in 60 seconds.

**I002**



**PENETROMETER**

Determines soil compaction. Operates with gravity and is very accurate. Calibrated in percentages. Determine the need for aerification and other cultural practices in seconds. Monitor compaction changes after tournaments and over time, or find out if your root zone is in good tilth.

**I003**

**INFILTROMETER**

Used to determine percolation rates of water in soil. Helps keep diseases to a minimum, adjust irrigation rates to save water, minimize run off, determine when to aerify and if percolation rates are improving.

**I005**



**SOIL PROFILE SAMPLER**

Slicing a sample 6" long by 3" wide and 1/2" thick. This tools jaws are hinged at the top for easy opening and inspection. Sample can be easily redeposited by keeping one side open and replacing in hole.

**I004G**



**KEYS**

**I45136**  
Valve Control Key  
- 36"



**RAIN GAUGE**

The 2 in 1 Rain Gauge is a set of one - 5 inch rain gauge and one - 1 inch sprinkler water collection gauge. They can be used for measuring rainfall as well as sprinkler water application amounts. Both gauges are marked in inches and centimeters.

**I012**



**DIGITAL THERMOMETER**

Shows temperature in Fahrenheit or Centigrade.

**I0091** - Fahrenheit

**I0092** - Centigrade







### MARKING FLAGS

Colors include: Green, Pink, Blue, Yellow, Fluorescent Orange, White, Red, and Orange. Come in bundles of 100 flags.

R015

### SPOTSHOT™



Ideal for:

- Leaching salts on greens
- Targeting hot spots on fairways, roughs, etc.
- Mound watering
- New seed grown in
- Other low volume watering



### LOW VOLUME PORTABLE SPRINKLER KIT

SpotShot™ is an expandable sprinkler system kit ideal for turf areas requiring low volume watering for extended periods. Connect the Starter Kit to a quick coupler (or golf sprinkler with the HoseTap™) and connect Add-On Kits for larger area needs.

### UHSSK



Starter Kit includes 20' of ½" flexible PVC tubing with connection fittings, pressure regulator, sprinkler base and low volume rotating sprinkler (20 ft. radius / 0.65 GPM - 0.16 in./hr.)

### UHSSK26



Add-On Kit includes 20' of ½" flexible PVC tubing with connection fittings, sprinkler base and low volume rotating sprinkler (20 ft. radius / 0.65 GPM - 0.16 in./hr.)

### UHSSAOK26



Micro-Sprinkler Options:

■ 20 ft. radius / 0.65 GPM (0.16 in./hr.)

**UHSS16**

■ 20 ft. radius / 1.2 GPM - (0.26 in./hr.)

**UHSS26**

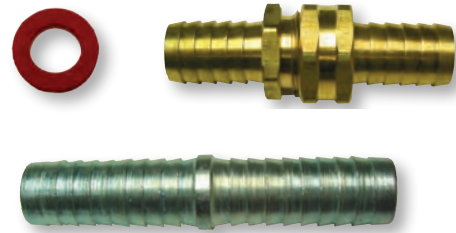

### HOSE FITTINGS

- I3005/8** 5/8" Hose Mender
- I3003/4** 3/4" Hose Mender
- I3001** 1" Hose Mender
- I3101** 1" Male/Female Coupler
- I3103/4** 3/4" Male/Female Coupler
- I3105/8** 5/8" Male/Female Coupler
- I3123/4** 3/4" Washer
- I3121** 1" Washer

SIGNAGE

RANGE &  
PRACTICE

TEE AREA

FAIRWAY

GREENS

CLUBHOUSE,  
PRO SHOP, &  
TOURNAMENT

RECYCLED  
PLASTICS

SAFETY,  
MAINTENANCE,  
& IRRIGATION

SIGNAGE  
RANGE & PRACTICE  
TEE AREA  
FAIRWAY  
GREENS  
CLUBHOUSE, PRO SHOP, & TOURNAMENT  
RECYCLED PLASTICS  
SAFETY, MAINTENANCE, & IRRIGATION

**AUDITMASTER™**

EXPERT Sprinkler Performance Testing Kits  
Increasing watering times to compensate for poorly performing sprinklers wastes a lot of water. Accurately measuring sprinkler application rates with Underhill® AuditMaster™ helps maximize water savings.



4" x 5" Marking flags on 21" wire (50-pack) are available in 6 colors.

AuditMaster Combo ST/LT Kit (pictured), includes large CatchCanPro cups (blue) and CatchCanPro Mini cups (30 each).

**IRAUD-STLT**

AuditMaster ST Kit excludes the large CatchCanPro cups. This kit is ideal for SMALL TURF audits.

**IRAUD-ST**

AuditMaster LT Kit excludes the CatchCanPro Mini cups. This kit is optimized for golf courses, sports fields and other LARGE TURF audits.

**IRAUD-LT**

**HEADCHECKER™**

Solid brass Pitot tube with liquid-filled 160 psi gauge. Easily maintain nozzle discharge pressures for highly uniform irrigation systems.

**I314HCH**  
HeadChecker™



**CATCHCAN PRO™**

Features:

- Self standing - easily anchors into turf, even on slopes
- Measures sprinkler application in inches or centimeters
- Unique design allows for shorter duration test
- Made of durable polypropylene engineered plastic
- Can be stacked for easy storage
- Each 10 pack kit comes with instructions

CatchCan Pro (CCPK-10) for LARGE TURF audits. Measures ml, cm, inches.

**I314CCPK**

CatchCan Pro Mini (CCPMK-10) for SMALL TURF audits. Measures inches.

**I314CCPMK**



**GOODYEAR RED  
HORIZON HOSE**

This 200 psi line lasts for ages. Available in 50', 75' and 100' lengths 3/4" and 1" diameters. End fittings included.

- I23050** 3/4" - 50'
- I23075** 3/4" - 75'
- I230100** 3/4" - 100'
- I26550** 1" - 50'
- I26575** 1" - 75'
- I265100** 1" - 100'

\* Custom longer lengths available upon request.



**PROFESSIONAL HOSE**

Designed to withstand the high pressure surges that occur during golf course use, up to a burst pressure of 800 PSI. Double cord reinforced for added strength, and abrasion resistant cover for added durability. Heavy duty brass couplings, constructed specifically to prevent coupling separation.

**I29675**  
3/4" x 75'

**I296100**  
3/4" x 100'

**CLEAR VINYL HOSE**



Heavy duty clear vinyl construction. Working pressure up to 150 PSI. Strong, lightweight, easy to handle. Not recommended in high heat areas. End fittings included.

- 150PSI
- I27550** 3/4" - 50'
  - I27575** 3/4" - 75'
  - I275100** 3/4" - 100'

- 125 PSI
- I28050** 1" - 50'
  - I28075** 1" - 75'
  - I280100** 1" - 100'

**GILMOUR  
FLEXOGEN HOSE**



Supreme quality hose. Lightweight and flexible. 500 PSI burst strength. End fittings included.

- I29450** 3/4" - 50'
- I29475** 3/4" - 75'
- I294100** 3/4" - 100'

- I29550** 1" - 50'
- I29575** 1" - 75'
- I295100** 1" - 100'

**GOODYEAR  
"GREENS KEEPER"**



An economical multipurpose hose for water and many spray solutions. Lightweight and easy to handle working pressure up to 250 PSI. End fittings included.

- I29250** 3/4" - 50'
- I29275** 3/4" - 75'
- I292100** 3/4" - 100'

- I29350** 1" - 50'
- I29375** 1" - 75'
- I293100** 1" - 100'

SIGNAGE  
RANGE & PRACTICE  
TEE AREA  
FAIRWAY  
GREENS  
CLUBHOUSE, PRO SHOP, & TOURNAMENT  
RECYCLED PLASTICS  
SAFETY, MAINTENANCE, & IRRIGATION

SIGNAGE  
RANGE & PRACTICE  
TEE AREA  
FAIRWAY  
GREENS  
CLUBHOUSE, PRO SHOP, & TOURNAMENT  
RECYCLED PLASTICS  
SAFETY, MAINTENANCE, & IRRIGATION

**WINTERGREEN TURF COVERS  
BY COVER-TECH INC**

Protecting greens with a Cover-Tech golf green cover is a must for any course. You can clearly see the damaging effects of a harsh winter from the image to the right.

Studies show that covering a golf green or any turf will reduce winter damage.

Key Benefits of WinterGreen Covers:

- Reduces risk of winter kill.
- Earlier spring greening for earlier openings.
- Speeds up germination.
- Reduces seed loss from the elements and birds.
- Promotes healthy roots and development.
- Reduces fertilizer evaporation.

Benefits of Cover-Tech WinterGreen Turf Covers over the competition:

- 65 years of experience in tarp manufacturing.
- 7 mil and thicker fabric.
- Long lasting UV treated reinforcing scrim.
- 4 layer chain stitched seams.
- 3 layer chain stitched edge.
- Breathable (Permeable) covers have a 5-year UV warranty.
- Waterproof (Impermeable) covers also available.
- Breathable covers are translucent for a greenhouse effect.

Supreme Green Permeable Cover 20'x 30'

**COV2030**

Supreme Green Permeable Cover 60'x 90'

**COV6090**

Supreme Green Permeable Cover Custom Sizes

CALL FOR QUOTE



**GREENS BLANKET**

**1022** BLANKET - 15' WIDE  
per roll foot (approx.)

**1022C** CUSTOMIZED TURF BLANKET

**1022S** TURF STAPLES (1000 PER CASE)

**1023425** BIODEGRADABLE STAKES - 4", 250 PER BOX

**1023450** BIODEGRADABLE STAKES - 4", 500 PER BOX

**1023625** BIODEGRADABLE STAKES - 6", 250 PER BOX

**1023650** BIODEGRADABLE STAKES - 6", 500 PER BOX

Covering your green during winter months is a great investment. It could allow you to start play earlier in the spring with greener, healthier turf by maximizing the greenhouse effect. They can also extend play in the winter months by not allowing the grass to go dormant from an early cold spell. Blankets can be customized to each individual green dimension ensuring proper coverage and contain ultra-violet stabilizers for longer product life.



**JETAIRE HIGH VELOCITY FAN**

- Available with 24" and 30" dia. fan blades
- Ideal for industrial/commercial and Golf Course applications
- Available with or without oscillation
- Moves a large concentration of air at distances of 100 feet or more
- Tilttable head for desired direction of air flow
- Optional mounting equipment for adapting fans to various applications such as pole, tree, column, or beam mount
- Motors are available in single or three phase
- Can be equipped with cool mist system
- Choice of Industrial Gray or Hunter Green

**I603DF**  
Dolly  
Mount Fan  
CALL FOR  
QUOTE



**I603PF**  
Oscillating  
Pedestal Fan  
CALL FOR  
QUOTE



**AERATION SYSTEMS**

**DURAPLATE™ DIFFUSER**

Keep your lakes healthy and clean. We have aeration systems of various sizes to cater to your needs. They are all built for rugged and dependable service.

The Quiet Line aerates lakes up to 25 acres. Very quiet operation up to 50psi for deeper situations. Powerful units that will keep lakes ice-free through the winter months, and will maintain an oxygen rich environment for fish and aquatic inhabitants.

**1800** CALL FOR QUOTE



**SOLAER™ SOLAR  
POWERED AERATOR**

Lakes up to 5 acres, and 4 diffusers. Ideal for remote areas without power. Units operate 20 hours per day and have battery back-up to allow many days use during cloudy periods. (Pat.# 6,676,83782).



Compression Unit

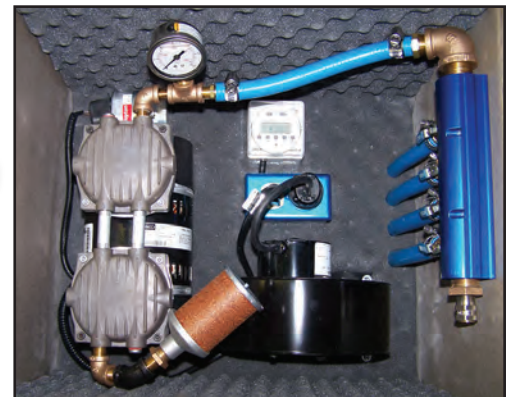

SIGNAGE

RANGE &  
PRACTICE

TEE AREA

FAIRWAY

GREENS

CLUBHOUSE,  
PRO SHOP, &  
TOURNAMENT

RECYCLED  
PLASTICS

SAFETY,  
MAINTENANCE,  
& IRRIGATION

SIGNAGE  
RANGE & PRACTICE  
TEE AREA  
FAIRWAY  
GREENS  
CLUBHOUSE, PRO SHOP, & TOURNAMENT  
RECYCLED PLASTICS  
SAFETY, MAINTENANCE, & IRRIGATION

**KASCO FOUNTAINS**



Kasco manufactures one of the most affordable and reliable fountains on the market today. Highly efficient low RPM motor design coupled with unit-specific propellers create excellent water flow, aeration, and pattern size, with very low power consumption. All Kasco fountains are ETL/UL approved as complete packages and include control panels with GFCI protection. Kasco fountains are the most cost effective to purchase, operate, maintain, and repair on the market today. Both 120V and 220V models are available and each is light weight and easy to install. Designed for use in salt water and includes mooring lines."

Kasco fountains range from as small as 1/4HP for the small backyard pond all the way up to the new 5HP for larger ponds and lakes to fit any size budget and project. The 1/4HP, 1400JF050 includes 5 interchangeable nozzles, control panel, and mooring ropes, is completely assembled and ships in a single box. Kasco fountains are perfect for shallow water operation with the 1/4HP needing only 12" and the large 5HP needing only 26" of water to operate. 1/4HP to 1HP units include a 2 year warranty and 2HP to 5HP include a 3 year warranty."

- I530** FOUNTAINS / AERATORS
- I530C** CABLES
- I530L** LIGHTS

CALL FOR QUOTE  
CALL FOR QUOTE  
CALL FOR QUOTE

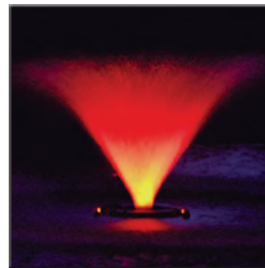
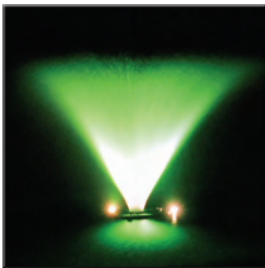

**MAGNOLIA**  
2 HP 14' H x 42' W  
3 HP 16' H x 52' W  
5 HP 19' H x 60' W



**MADRONE**  
2 HP 13' H x 36' W  
3 HP 15' H x 46' W  
5 HP 17' H x 50' W



**PALM**  
2 HP 13' H x 24' W  
3 HP 15' H x 28' W  
5 HP 18' H x 30' W



**MAHOGANY**  
2 HP 12' H x 34' W  
3 HP 14' H x 42' W  
5 HP 16' H x 50' W

# PROUD TO SUPPORT YOU

Eagle One Golf Products understands the vast array of goals you, our customer groups, have in any one year. Through National, State and Regional associations much is achieved towards Education advancement, Environmental considerations, Benevolent concerns, Promotion of the game and much more. It is with this in mind Eagle One Golf Products is proud to support you, to the maximum of our abilities, at these three levels and more. The following is a summary of some of our support:

VGM – PREFERRED SUPPLIER

AVENDRA – PREFERRED SUPPLIER

FARMERS INSURANCE OPEN – BREAKFAST SUPPLIER TO SUPERINTENDENTS

BOB HOPE CLASSIC - BREAKFAST SUPPLIER TO SUPERINTENDENTS

GCSAA - SILVER PARTNER

GCSAA - AFFILIATE MEMBER

GCSAA - ENVIRONMENTAL INSTITUTE OF GOLF – EXECUTIVE CLUB

GCSAA – GIS TRADE SHOW – ORLANDO

CANADIAN GCSA – TRADE SHOW

STATE ASSOCIATIONS – NUMEROUS TOURNAMENT SPONSOR SIGNS

- NUMEROUS EVENT SPONSOR SIGNS
- PRODUCT DONATIONS
- VOLUNTEER STAFF - It is likely one of our wide network of sales representatives has worked with you on the board of your association, greeted you at a tournament registration or holiday function or been up before dawn putting out tee sponsor signs.

TEXAS TURFGRASS ASSOCIATION – TRADE SHOW

FLORIDA SUPERINTENDENTS ASSOCIATION – EVENT SIGNS

ROCKY MOUNTAIN TURFGRASS ASSOCIATION- TRADE SHOW

REGIONAL ASSOCIATIONS

- BENEVOLENT TOURNAMENTS – PROVIDE AND INSTALL EVENT SIGNAGE
- AUCTION ITEMS
- GIVE A WAYS
- VOLUNTEER STAFF
  
- MONTHLY MEETING - PROVIDE EVENT SIGNAGE
- ADVERTISING
- VOLUNTEER STAFF
- ASSOCIATE MEMBERSHIPS

PGA SECTIONAL PROGRAMS

NATIONAL GOLF FOUNDATION – MEMBER

UNITED STATES GOLF ASSOCIATION – MEMBER

NATIONAL FEDRATION OF INDEPENDENT BUSINESSES - MEMBER

The Preferred Supplier for



## **TERMS & CONDITIONS**

### **RETURNS**

- All merchandise to be returned must have a Return Authorization Number, which is approved by an Eagle One Golf Products sales representative.
- Requests for returns must be made within 30 days from date of purchase.
- All returns are subject to a 15% restocking charge, as well as return freight to our distribution center (where applicable).
- Items returned must be unused, in saleable condition and in their unopened original packaging. A copy of the invoice or the packing slip describing what is being returned and why must be provided.
- Credit cannot be issued for damaged or obsolete items.
- Special Order items (non-stock) are returnable within 10 days of invoice date with a 25% restocking fee. All return freight charges are the responsibility of the customer.
- Custom products are not returnable.
- Due to the potential of contamination, we cannot accept returns on Sprayers or Spreaders.
- Your complete satisfaction is our goal. Please notify us promptly if your order is inaccurately fulfilled.

### **DESIGN & SPECIFICATIONS**

Our product specifications may change from time to time, and please know that we do it to improve the performance or appearance. We feel assured that our on-going development efforts are beneficial to our customers as a whole, but for those individual cases in which changes cause an inconvenience, we apologize. Please call with any concerns or problems and we will do our best to accommodate your specific needs.

### **FREIGHT DAMAGE OR SHIPMENT DISCREPANCY**

Note any discrepancy or damage directly on the bill of lading at time of delivery. Contact the carrier to file a claim and also notify the Eagle One Golf Products Customer Service Department. Please note that once the bill of lading is signed, the customer assumes all responsibility for the quantity received as being accurate and correct. Any concealed quantity discrepancy or damage which may have occurred in transit must be reported within ten (10) days of delivery. Thereafter, the liability for any delivery-related problems rests with the customer.

### **COMMERCIAL CREDIT TERMS**

For customers with established commercial credit, full payment of all invoices is expected on the due date. Invoices are generated at the point of the sales transaction at the time of purchase. A service charge of 1.5% per month is imposed on all overdue balances.

If commercial credit has not been pre-established, payment can be made with the order or purchase through Visa, Mastercard, American Express, Discover, bank or cashier's check, cash or money order.

### **PRICING**

Prices F.O.B. shipping point unless otherwise stated. Prices subject to change at any time. Terms and conditions of sale are subject to change at Eagle One Golf Products' discretion without prior notice.

### **WARRANTY**

Items manufactured by Eagle One Golf Products carry a 12 month warranty.

Applicable product warranties and limitations are provided on labels or operator and parts manuals, depending on the product type.

Eagle One Golf Products associates are not authorized to make any representations or give any additional warranties/guarantees, expressed or implied, regarding products.





**REPRESENTATIVE / DISTRIBUTOR**

**"Always On The Right Course"**

**800-448-4409**

Phone: 714-983-0050

Fax: 714-203-8448

[WWW.EAGLEONEGOLF.COM](http://WWW.EAGLEONEGOLF.COM)

[INFO@EAGLEONEGOLF.COM](mailto:INFO@EAGLEONEGOLF.COM)

WEST COAST, USA  
Sales, Administration & Warehouse  
1340 N. Jefferson St.  
Anaheim • CA • 92807