



**STANDARD
GOLF** COMPANY

2015

WORLD'S MOST
COMPLETE LINE
OF GOLF COURSE
ACCESSORIES

REPRESENTED BY THE WORLD'S FINEST GOLF COURSE DISTRIBUTORS

GREAT SERVICE.

FAST, PROFESSIONAL HELP.

"Top quality products and the best value possible is Standard Golf's mission. The true measure of excellence is having great people in place who consistently provide our customers with the ultimate buying experience."



Peter Voorhees
President/Owner

CONTENTS

New Products 4-7

2015 Products

Think Pink	8
Ball Washers	9-10
Bunker Rakes	11-13
Club Washers	14
Cups	15-18
Divot Mix Storage	19-20
Fixtures & Benches	21
Flags	22-29
Flagsticks	30-32
Hazard Markers	33-35
Hole Cutters & Shells	36-37
Maintenance & Turf Tools	38-43
Marking Paint	44-45
Practice Green	46-49
Range Equipment & Accessories	50-56
Rope & Chain Stakes	57-58
Safety Equipment	59
Signs	60-66
Spike Cleaners	67-68
Tee Consoles	69-73
Tee Markers	74-78
Tee Towels	79
Trash Containers	80-82
Water Stations	83-85
Yardage Markers	86-88
ProLine	89-90
Parts List	91-99

INTRODUCING

NEW!

FULL COVERAGE FLAGS!



▲ Image is mirrored on the back



▲ Full vibrant color on both sides

- ▶ Golf flags like you have never seen them before! Any color and any pattern!
- ▶ Photo-quality color flags with mirror image printing.

To order add an F to the end of the dye sub part numbers. An additional fee will be added. Contact your distributor for more information.



RUST-OLEUM SPRAYSMART MARKING PAINT SYSTEM

Golf course markings have never been easier! The SpraySmart system is a patent-pending, propellant free spray system for spraying marking paint. The reusable device operates on compression technology to spray paint using SpraySmart disposable paint pouches. You get the same great coverage, color and durability you would expect from a Rust-Oleum product but with less waste.

- ▶ Propellant free formula sprays on any substrate and in any weather condition; even works on dew covered grass.
- ▶ Designed to fully empty each paint pouch – no waste.
- ▶ Bright and durable colors are safe for grass.
- ▶ Space saving paint pouches can be easily stored or shipped (including overnight air shipping).
- ▶ Device fits in existing marking paint wands.
- ▶ Non-clogging spray tip provides one pass coverage.

57000 SpraySmart Device
55000 Marking Wand



SPRAYSMART PAINT POUCHES
10.5 oz. pouches (311 ml)
Twelve pouches per case

White	57001
High Visibility Yellow	57002
Safety Red	57003
Alert Orange	57004
Safety Green	57005
Caution Blue	57006
Fluorescent Pink	57007
Fluorescent Orange	57008
Fluorescent Green	57009
Fluorescent Red/Orange	57010
Black	57011
Caution Yellow	57012
Safety Purple	57013



NEW PRODUCTS FOR 2015

TOUR PRO

When mediocrity isn't an option and only perfection will do, turn to Standard Golf's Tour Pro Bunker Rake. No other bunker rake can make smooth, level, playable surfaces like the Tour Pro.

- ▶ 20" (51 cm) and 25" (63 cm) heads ensure tracks are covered with minimum effort, while pioneering design generates tournament quality surfaces.
- ▶ When durability is a must, the exclusive Gator Grip Handle is your best option, available in both 60" (152 cm) and 72" (183 cm) lengths.
- ▶ A single self-tapping screw (included) is all you need for assembly.

20" (51 CM) TOUR PRO

	ALUMINUM HANDLE	COMPOSITE HANDLE	GATOR GRIP HANDLE	ALUMINUM CURVED HANDLE
	54" (137 cm) 7/8" D (2.2 cm)	54" (137 cm) 7/8" D (2.2 cm)	60" (152 cm) 7/8" D (2.2 cm)	64" (163 cm) 7/8" D (2.2 cm)
Green	11760	11700	11720	11750
Brown	-	-	11730	-

Priced individually. Gator Grip, aluminum and composite handles sold in multiples of twelve. Curved handles sold in multiples of six.

GATOR GRIP HANDLE

Toughness matched only by its namesake. Gator Grip Handles put an end to all the problems associated with degrading fiberglass rake handles.

- ▶ Specially formulated polymer coating adds durability and strength capable of withstanding even the worst conditions.
- ▶ No more splinters, chipping, peeling or cracking. Finally a bunker rake handle whose performance surpasses your expectations.
- ▶ Both 60" (152 cm) and 72" (183 cm) lengths fit Tour Smooth II, Tour Pro and Accuform bunker rake heads.



	GATOR GRIP HANDLE 60" (152 cm) 7/8" D (2.2 cm)	GATOR GRIP HANDLE 72" (183 cm) 7/8" D (2.2 cm)
Green	11200	11210
Brown	11201	11211

ORDER WITH
GATOR GRIP HANDLE
FOR SUPERIOR DURABILITY!



WATCH IT
WORK!



www.standardgolf.com

25" (64 CM) TOUR PRO

	GATOR GRIP HANDLE 72" (183 cm) 7/8" D (2.2 cm)
Green	11770
Brown	11780

Priced individually. 72" (183 cm) Gator Grip and aluminum handles sold in multiples of six.

TOUR SMOOTH II

Time-tested design and performance of the Tour Smooth bunker rake just got an upgrade. Improved rake assembly and the addition of the exclusive Gator Grip Handle makes the Tour Smooth II a must for all courses.

- ▶ Smooths both fine and coarse sand into perfect playing conditions quickly and easily.
- ▶ Pair the Tour Smooth II with the exclusive 60" (152 cm) Gator Grip Handle for a level of performance unmatched by any of the competitors.
- ▶ A single self-tapping screw (included) is all you need for assembly.

15" (38 CM) TOUR SMOOTH II

	ALUMINUM HANDLE	COMPOSITE HANDLE	GATOR GRIP HANDLE	ALUMINUM CURVED HANDLE
	54" (137 cm) 7/8" D (2.2 cm)	54" (137 cm) 7/8" D (2.2 cm)	60" (152 cm) 7/8" D (2.2 cm)	64" (163 cm) 7/8" D (2.2 cm)
Green	11860	11800	11820	11850
Brown	-	-	11830	-

Priced individually. Gator Grip, aluminum and composite handles sold in multiples of twelve. Curved handles sold in multiples of six.







NEW!



DIRECTIONAL STAKES

- ▶ Markers used to direct golfers around sensitive areas.
- ▶ 6 ¼" (15.9 cm) white recycled plastic stakes with a 4" (10 cm) green, blue, red or yellow vinyl cap.
- ▶ 5 ¾" (14.6 cm) coated steel spike.
- ▶ Round 1 ½" (3.8 cm) diameter
- ▶ Sold in quantity of 25, includes a black carrying bucket.

6 ¼" (15.9 cm) long, plus 5 ¾" (14.6 cm) spike

	Yellow	16925
	Green	16935
	Red	16950
	Blue	16975



**CUSTOMIZE YOUR GREEN LINE
PRODUCTS!
NO COLOR LIMITS.**

- ▶ Promote your brand by adding a custom logo to your Green Line products.
- ▶ Logos are engraved with colored resin or inlaid with full-color decal.

21300GL Green Line Logo Charge

DON'T SEE EXACTLY WHAT YOU WANT?

Then let us build it for you. Contact your local distributor for more information.





Example of a customized event flag

CUSTOM EVENT FLAGS

- ▶ Every flag can be customized at no additional cost! (Minimum orders of nine.)
- ▶ Simply email your artwork to art@standardgolf.com to see if you qualify for FREE artwork setup or better yet give us a call.
- ▶ Cloth tube design lays flat; ideal for framing.
- ▶ Available on white polyester only.
- ▶ Limited 30-day warranty.

A PORTION OF THE PROCEEDS GOES TO THE FIGHT AGAINST BREAST CANCER

EVENT FLAGS | WHITE

19 7/8" x 13 7/8" (50.5 cm x 35.2 cm)	Set of Nine	Single
Customized Event Flag	25650	25652

Minimum order of nine.
Each event flag design can be individually customized.

PINK FLAGS | DUPONT SOLARMAX NYLON

- ▶ These pink flags are a perfect addition to any Breast Cancer Event.

200 Denier	Set of Nine	Single
Pink Tube Lock	22420T	22422T

200 Denier	Set of Nine	Single
Pink/White Checked Tube Lock	22570T	22572T



CROWN ALUMINUM TEE MARKER

- ▶ Ventilated design preserves tee grass.
- ▶ Pink powder-coated aluminum.

6" (15 cm) diameter 2" (5 cm) high

Pink	05710
------	-------



RIJI CUP

- ▶ Finished with chemical-resistant polymers.
- ▶ Meets all USGA regulations.

6" (15 cm) high 4 1/4" (10.8 cm) diameter
18200P Riji Cup



ALUMINUM CUP

- ▶ Unbeatable chip-resistant finish.
- ▶ Meets all USGA / R&A regulations.

6" (15 cm) high 4 1/4" (10.8 cm) diameter
18303P Aluminum Cup



ST2000 SMART-FIT CUP

- ▶ Notched-ferrule flagsticks fall right into place every time without twisting, sticking or sinking.
- ▶ Meets all USGA regulations.

6" (15 cm) high 4 1/4" (10.8 cm) diameter
18333P Aluminum
ST2000 Cup

Not compatible with grooved ferruled flagsticks.



SPECIAL EVENT CUPS

- ▶ Pink, powder-coated steel cup in 6" (15.2 cm) and 8" (20.3 cm) sizes. Also available in pink plastic.
- ▶ Shorter-depth 8" (20.3 cm) cup is easily installed with our 8" (20.3 cm) Pro II Hole Cutter.

6" (15 cm) high
18600P 6" (15.2 cm)
Cup

3" (8 cm) high
18700P 8" (20.3 cm)
Cup

18775P 8" (20.3 cm)
Plastic Cup

ROYALINE FLAGSTICKS

Our most popular, economical flagstick for years ... and the favorite of golf courses everywhere. Ultra-strong, resilient, solid fiberglass construction.

1/2" (1.3 cm) diameter from top to bottom.	7 1/2' (2.3 m)
Pink	26107
White/Pink Stripe	26108



WORLD-CLASS WASHERS!

FIRST-CLASS VALUES



Don't see a color you like? We can help! Contact your local distributor for more information.



PREMIER BALL WASHER (SINGLE BALL)

- ▶ Mounts over-the-post for added structural integrity.
- ▶ Easy to maintain with large drain and tamper-resistant, leak-proof drain plug.
- ▶ Simple design, only one moving part.
- ▶ New and improved brush design.

Capacity: 7.5 pints (3.6 L)

Red	01425
Green	01450
Black	01470

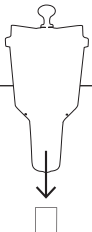

INSTALLATION

All washers mount on any Standard Golf ball washer or console stand or attach to any 2 3/8" (6.0 cm) O.D. post.

OPTIONAL ASHTRAY

- ▶ Screws into ball washer collars.

01430 Ashtray with Holder – Black



SPARKLEEN ECOMAX DETERGENT TABLETS

- ▶ New environmentally friendly, concentrated formula only requires one tablet per ball washer for optimal cleaning power.
- ▶ Fizzing action dissolves tablet quickly in any water temperature. No measuring, no waste.
- ▶ Anti-bacterials keep solution fresh, even in hot weather.

03100 450-Count Jar



BALL WASHERS



MEDALIST BALL WASHER (SINGLE BALL)

- ▶ Economical compact package with sleek, tapered frame.
- ▶ Mounts inside the post.
- ▶ Simple design, only one moving part.
- ▶ New and improved brush design.

Capacity: 3.25 pints (1.6 L)

Red	01525
Green	01550
Black	01570

Don't see a color you like? We can help! Contact your local distributor for more information.



Free engraving on orders of 9 or more when using same logo.

CLASSIC BALL WASHER (FOUR BALL)

- ▶ Our most popular washer.
- ▶ Rugged. Affordable.
- ▶ Available in seven different colors.
- ▶ Crank-style washer with four-ball capacity.
- ▶ Built-in overflow tubes prevent leaks and soap buildup.
- ▶ New and improved brush design.

Capacity: 3.7 pints (1.8 L)

Red	01325
Green	01350
Black	01370
Yellow	01300
Brown	01340
Blue	01375
White	01395

01398 Side Case Engraving – Black, Gold or White

SPARKLEEN LIQUID DETERGENT

- ▶ Concentrated formula. Economical to use – just 0.5 oz. (14.2 ml) per ball washer.
- ▶ Formulated for use in all brands of ball washers, including range ball washers.
- ▶ Won't damage washers or internal parts.
- ▶ Will not become rancid in hot weather.



One-gallon (3.8 L) containers packaged and sold in 4-gallon cases

03300 Gallons - Case of 4

One-pint (0.5 L) containers packaged and sold in 12-pint cases

03301 Pints - Case of 12

INTRODUCING TOUR PRO

ORDER WITH
GATOR GRIP HANDLE
FOR SUPERIOR DURABILITY!



Competitor

Tour Pro

TOUR PRO VS. THE COMPETITION!

It's wider!
It's smoother!
It's more versatile!
And built to last!

WATCH IT
WORK!



www.standardgolf.com

TOUR PRO

When mediocrity isn't an option and only perfection will do, turn to Standard Golf's Tour Pro Bunker Rake. No other bunker rake can make smooth, level, playable surfaces like the Tour Pro.

- ▶ 20" (51 cm) and 25" (63 cm) heads ensure tracks are covered with minimum effort, while pioneering design generates tournament quality surfaces.
- ▶ When durability is a must, the exclusive Gator Grip Handle is your best option, available in both 60" (152 cm) and 72" (183 cm) lengths.
- ▶ A single self-tapping screw (included) is all you need for assembly.

20" (51 CM) TOUR PRO

	ALUMINUM HANDLE 54" (137 cm) 7/8" D (2.2 cm)	COMPOSITE HANDLE 54" (137 cm) 7/8" D (2.2 cm)	GATOR GRIP HANDLE 60" (152 cm) 7/8" D (2.2 cm)	ALUMINUM CURVED HANDLE 64" (163 cm) 7/8" D (2.2 cm)
Green	11760	11700	11720	11750
Brown	-	-	11730	-

Priced individually. Gator Grip, aluminum and composite handles sold in multiples of twelve. Curved handles sold in multiples of six.

25" (64 CM) TOUR PRO

	GATOR GRIP HANDLE 72" (183 cm) 7/8" D (2.2 cm)
Green	11770
Brown	11780

Priced individually. 72" (183 cm) Gator Grip handles sold in multiples of six.

BUNKER RAKES

GATOR GRIP HANDLE

Toughness matched only by its namesake. Gator Grip Handles put an end to all the problems associated with degrading fiberglass rake handles.

- ▶ Specially formulated polymer coating adds durability and strength capable of withstanding even the worst conditions.
- ▶ No more splinters, chipping, peeling or cracking. Finally a bunker rake handle whose performance surpasses your expectations.
- ▶ Both 60" (152 cm) and 72" (183 cm) lengths fit Tour Smooth II, Tour Pro and Accuform bunker rake heads.

	GATOR GRIP HANDLE 60" (152 cm) 7/8" D (2.2 cm)	GATOR GRIP HANDLE 72" (183 cm) 7/8" D (2.2 cm)
Green	11200	11210
Brown	11201	11211



TOUR SMOOTH II

Time-tested design and performance of the Tour Smooth bunker rake just got an upgrade. Improved rake assembly and the addition of the exclusive Gator Grip Handle makes the Tour Smooth II a must for all courses.

- ▶ Smooths both fine and course sand into perfect playing conditions quickly and easily.
- ▶ Pair the Tour Smooth II with the exclusive 60" (152 cm) Gator Grip Handle for a level of performance unmatched by any of the competitors.
- ▶ A single self-tapping screw (included) is all you need for assembly.

15" (38 CM) TOUR SMOOTH II

	ALUMINUM HANDLE 54" (137 cm) 7/8" D (2.2 cm)	COMPOSITE HANDLE 54" (137 cm) 7/8" D (2.2 cm)	GATOR GRIP HANDLE 60" (152 cm) 7/8" D (2.2 cm)	ALUMINUM CURVED HANDLE 64" (163 cm) 7/8" D (2.2 cm)
Green	11860	11800	11820	11850
Brown	–	–	11830	–



Priced individually. Gator Grip, aluminum and composite handles sold in multiples of twelve. Curved handles sold in multiples of six.

CART RAKES

Convenient, economical, time-saving bunker rakes designed specifically for carts.

- ▶ Shorter 48" (122 cm) handle and 15" (38 cm) high-impact plastic head fits most golf cart bagwells.

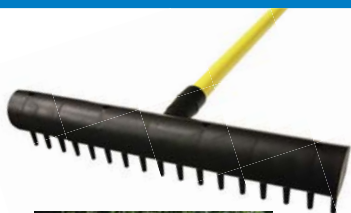

WOOD HANDLE
48" (122 cm)
7/8" D (2.2 cm)

Yellow	11400
Green	11425

Priced individually. Sold in multiples of twelve.

DUO-RAKE

One side furrows, the top side smooths and the entire rake floats!

- ▶ 15" (38 cm) high-impact plastic head.
- ▶ Now with new stronger, gusset-reinforced high-impact plastic head.



	ALUMINUM HANDLE	ALUMINUM HANDLE	COMPOSITE HANDLE	CURVED HANDLE	COMPOSITE HANDLE
	54" (137 cm)	54" (137 cm)	54" (137 cm)	64" (163 cm)	72" (183 cm)
	15/16" D (2.4 cm)	15/16" D (2.4 cm)	1" D (2.5 cm)	7/8" D (2.2 cm)	7/8" D (2.2 cm)

	ALUMINUM HANDLE	ALUMINUM HANDLE	COMPOSITE HANDLE	CURVED HANDLE	COMPOSITE HANDLE
Natural	11500	-	-	-	-
Tan	-	-	11560	-	-
Gold	-	-	-	11530	-
Yellow	-	11525	-	-	-
Green	-	11575	11590	11540	11545
Black	-	-	11595	-	-

Priced individually. Aluminum and composite handles sold in multiples of twelve. Curved handles and 72" handles sold in multiples of six.

TOUR-LITE RAKE

Value-priced favorite of superintendents.

- ▶ Impact-resistant, 15" (38 cm) polyethylene molded head.
- ▶ Ultralight, plastic-coated steel handle.
- ▶ Redesigned neck for added strength and durability.

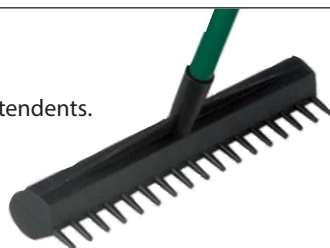

ULTRALIGHT STEEL HANDLE
54" (137 cm)
7/8" D (2.2 cm)

Yellow	12350
Green	12375

Priced individually. Sold in multiples of twelve.

ECONOMY RAKE

Full-size performance for smaller-sized budgets.

- ▶ Wooden or ultralight, plastic-coated steel handles.
- ▶ Tough, high-impact 15" (38 cm) molded head (and handle) are light enough to float.



	WOOD HANDLE	ULTRALIGHT STEEL HANDLE
	48" (122 cm)	48" (122 cm)
	7/8" D (2.2 cm)	7/8" D (2.2 cm)

Yellow	11600	11650
Green	11625	11675

Priced individually. Sold in multiples of twelve.

CURVED RAKE HANDLE

For Duo, Tour Smooth II and Tour Pro Rakes.

- ▶ Better visibility than traditional style handles.
- ▶ Less wear from moisture and sand.
- ▶ Less chance of damage from carts and bunker traffic.
- ▶ Packaged six per carton.

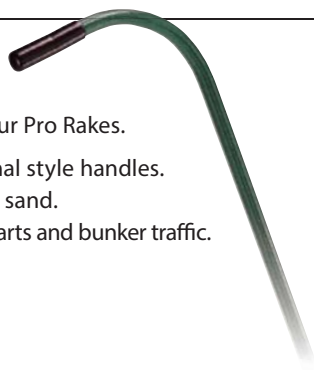

RAKE PLACEMENT DECALS

PLACE RAKE IN BUNKER

PLACE RAKE OUTSIDE BUNKER

- ▶ Only available in English.
- ▶ Twelve per package.

1" x 5 1/2" (3 cm x 14 cm)

11000 Place Rake In Bunker

1" x 7" (3 cm x 18 cm)

11050 Place Rake Outside Bunker



Use with SparkKleen
Ball Cleaner Solution.
(See page 10.)

RANGE MATE CLUB WASHER

- ▶ Gentle, no-splash brushes will handle woods and irons.
- ▶ Efficient, effective design with replaceable brushes.
- ▶ Large-capacity, fade-resistant 9-gallon (34 L) polyethylene containers, reinforced with steel frame.

Gray Granite	01600
Hunter Green	01650

01602 Replacement Brush

RECYCLED SQUARE CLUB WASHER

- ▶ Our finest Green Line club washer. Smart-looking, slatted-style cubical, 100% recycled material.
- ▶ Compact. 9-gallon (34 L) capacity. Perfect for range and par 3s.

22"H x 18"W x 18"D (56 cm x 46 cm x 46 cm)

Green	200020GN
Brown	200020BR
Black	200020BK

01602 Replacement
Brush



RECYCLED CLUB WASHER

- ▶ Premier Green Line club washer.
- ▶ Rugged construction includes 5-gallon (19 L) bucket and hand brush.

32"H x 17"W (81 cm x 43 cm)

Green	200010GN
Brown	200010BR
Black	200010BK



"I've been around this game in many different capacities for more than 45 years. The friendships formed and the knowledge gained has been immeasurable. I hope I have been a positive influence in the lives of all those I have met who have been involved in this great game called golf."

Steve
National Sales Manager

IF IT STICKS, TWISTS OR LEANS IT'S NOT A SMART-FIT



**WATCH IT
WORK!**



www.standardgolf.com

ST2000 SMART-FIT CUPS

- ▶ Notched-ferrule flagsticks fall right into place every time without twisting, sticking or sinking.
- ▶ Bonderite aluminum cups for maximum life and the most chip-resistant coating around.
- ▶ High-strength plastic cups molded with chemical-resistant polymers provide a brilliant, lasting finish.
- ▶ Meets all USGA regulations.
- ▶ U.S. Patents #5,964,667; #6,113,503 and #7,033,280B. European Patent #1024864131.

6" (15 cm) high 4 1/4" (10.8 cm) diameter

18333 Aluminum ST2000 Cup

18222 Plastic ST2000 Cup

18333P Aluminum ST2000 Cup - Pink

Not compatible with grooved ferruled flagsticks.



*Bonderite coated
aluminum cups. The most
chip-resistant coating
around.*



*High-strength plastic cups
are molded with chemical-
resistant polymers for a
brilliant, lasting finish.*

CHOOSE ALUMINUM OR HIGH-STRENGTH PLASTIC CUPS.



RIJI CUP

- ▶ Value-priced and ideal for less demanding conditions.
- ▶ Brilliant white; finished with chemical-resistant polymers.
- ▶ Meets all USGA regulations.

6" (15 cm) high 4 1/4" (10.8 cm) diameter

- 18200 Riji Cup
- 18200P Riji Cup - Pink
- 18250 British Riji Cup
For British Ferrules only.



ALUMINUM CUP

- ▶ Unbeatable chip-resistant finish.
- ▶ Six "feet" on bottom of cup eliminate sinking.
- ▶ Meets all USGA / R&A regulations.

6" (15 cm) high 4 1/4" (10.8 cm) diameter

- 18303 Aluminum Cup
- 18303P Aluminum Cup - Pink



PLASTIC PRACTICE GREEN CUP

- ▶ This cup features molded plastic construction and reinforced webs.

4" (10 cm) high 4 1/4" (10.8 cm) diameter

- 18100 Plastic Practice Green Cup



ALUMINUM PRACTICE GREEN CUP

- ▶ Bonderite aluminum with the most chip-resistant coating around.
- ▶ Beveled bottom edge design makes cup easier to insert and remove.

4" (10 cm) high 4 1/4" (10.8 cm) diameter

- 18150 Aluminum Practice Green Cup



8" (20.3 cm) Cup



SPECIAL EVENT CUPS

- ▶ Powder-coated steel cup in 6" (15.2 cm) and 8" (20.3 cm) sizes. Also available in pink plastic.
- ▶ Fits standard-sized flagsticks.
- ▶ Great addition for "big hole" events.
- ▶ Shorter-depth 8" (20.3 cm) cup is easily installed with our 8" (20.3 cm) Pro II Hole Cutter.

	6" (15.2 CM) STEEL CUP 6" (15 cm) high	8" (20.3 CM) STEEL CUP 3" (8 cm) high	8" (20.3 CM) PLASTIC CUP 3" (8 cm) high
□ White	18600	18700	18775
■ Pink	18600P	18700P	18775P



 **WATCH IT WORK!**
www.standardgolf.com

E-ZEE WHITE HOLE WHITENER SYSTEM

- ▶ Clean, crisp white holes made quick and easy!
- ▶ Simply insert paint can into tool and rotate.
- ▶ Improved formula maximizes whiteness on dirt.
- ▶ Built-in shield protects cup and green from overspray.
- ▶ One-piece patented design; no assembly required.
- ▶ No purging required between uses.
- ▶ Starter kit includes tool, plus one case of paint. [Six 15-ounce (.42 kg) cans per case.]

55500 E-ZEE White Starter Kit

55600 E-ZEE White Tool

55700 E-ZEE White Paint (Case)



Shown as a cutaway for illustrative purposes.

SAND GREEN CUP

- ▶ Sturdy steel construction designed for 100% sand greens.
- ▶ Remove the inner shell to empty sand.

6" (15 cm) high 4 1/4" (10.8 cm) diameter

18400 Sand Green Cup

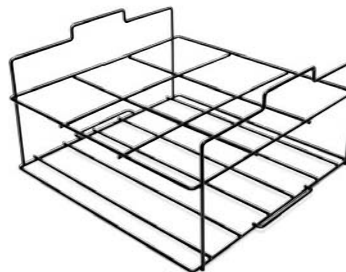
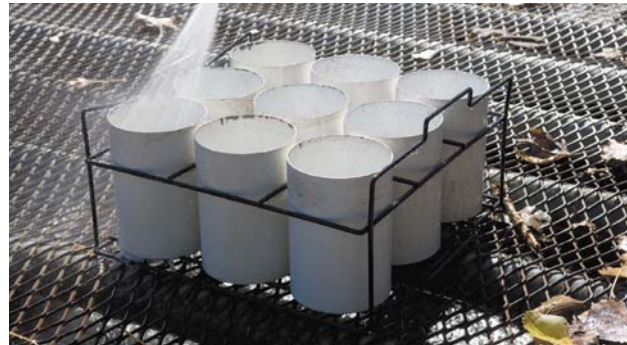

CUP CADDIE

- ▶ Handy for maintaining and rotating cups.
- ▶ Cups look better, last longer, and players notice the difference!

18990 Cup Caddy

POWDER-COATED CUP COVERS

- ▶ Rotate cup covers instead of cups.
- ▶ Keeps holes free of top dressing material and debris.
- ▶ Sits on top of the cup, flush with surface of the green.
- ▶ 4 ¼" (10.8 cm) cover is powder-coated steel. 6" (15.2 cm) and 8" (20.3 cm) covers are powder-coated aluminum.

1" (2.5 cm) high 4 ¼" (10.8 cm) diameter

18500 4 ¼" (10.8 cm) Cup Cover

18650 6" (15.2 cm) Cup Cover

18750 8" (20.3 cm) Cup Cover

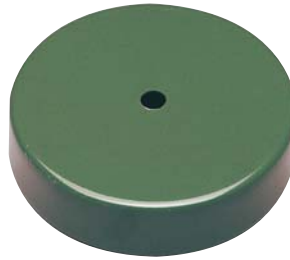

Note: Use Cup Setter to ensure proper cup depth of 1" (2.5 cm).

RECYCLED RUBBER CUP COVER

- ▶ For low-play seasons or during top dressing.
- ▶ Economical, recycled cover "fills" top of hole; doesn't damage mowers.
- ▶ Sits on top of the cup, flush with surface of the green.

1" (2.5 cm) high 4 ¾" (10.6 cm) diameter

18550 Rubber Cup Cover

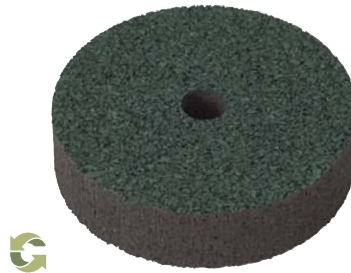

Note: Use Cup Setter to ensure proper cup depth of 1" (2.5 cm).

RECYCLED HOLE REDUCER

- ▶ Ideal for practice greens.
- ▶ Helps players fine-tune putting skills.
- ▶ Sits flush on top of the cup to reduce size of cup opening by 1" (2.5 cm).

1" (2.5 cm) high 4 ¾" (10.6 cm) diameter

18000 Rubber Hole Reducer



Note: Use Cup Setter to ensure proper cup depth of 1" (2.5 cm).

CUP HOOK

- ▶ Simple and easy way to remove any style cup.

11 ½" (29 cm) long

33200 Cup Hook

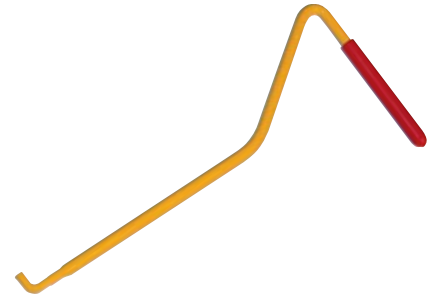

CUP SETTER

- ▶ Set it, step on it and lift it out.
- ▶ Sets cup to USGA-specs – 1" (2.5 cm) – below surface of the green.
- ▶ Flattens and smoothes crowning caused by hole cutters.
- ▶ Minimizes damage to the rims of aluminum cups.

30100 Cup Setter

"If you want to accomplish anything in life, you have to enjoy what you're doing. That's why I work here. Everyone here shares a passion for this game and the superintendents who nurture it."

Lind
Account Representative



MAKE IT GREEN LINE



- ▶ 100% recycled material with stainless steel hardware.
- ▶ Select any of three different colors!

ROUND DIVOT MIX BOXES

- ▶ Convenient handle-style lid.
- ▶ Includes liner and 16 oz. (0.5 L) scoop.



	3½-GALLON (13 L) 14 ½"H x 14"W (37 cm x 36 cm)	5-GALLON (19 L) 17 ½"H x 14 ½"W (44 cm x 37 cm)	10-GALLON (38 L) 21"H x 19"W (53 cm x 48 cm)
--	--	---	--

Green	200050GN	200060GN	200070GN
Brown	200050BR	200060BR	200070BR
Black	200050BK	200060BK	200070BK

DIVOT MIX BOXES

- ▶ Hinged lid and holding strap prevent hinge damage.
- ▶ Includes 16 oz. (0.5 L) scoop.



	3½-GALLON (13 L) 12 ½"H x 12"W x 12"D (32 cm x 30 cm x 30 cm)	5-GALLON (19 L) 17"H x 11"W x 9"D (43 cm x 28 cm x 23 cm)
--	---	---

Green	200040GN	200030GN
Brown	200040BR	200030BR
Black	200040BK	200030BK



SEED AND SOIL BUTLER

- ▶ Ideal for ranges and par 3s involving heavy iron play.
- ▶ Large 9-gallon (34 L) polyethylene container with steel frame support.
- ▶ Includes steel stand and 8 oz. (0.25 L) scoop.

19" (48 cm) high 15" (38 cm) diameter

Gray Granite	18960
Hunter Green	18970



JUNIOR SEED AND SOIL BUTLER

- ▶ Durable polyethylene container with hinged lid; plus stand and 8 oz. (0.25 L) scoop.
- ▶ Includes "Fill & Smooth Divots" and "Scorecards & Pencils" decals (2 of each).

Capacity: 4 gallon (15 L) 13" (33 cm) high

Hunter Green	18930
Black	18940



CART-MOUNTED SEED AND SOIL CADDIE

- ▶ Mounts to framework or basket of any golf cart – horizontally or vertically.
- ▶ Includes 40 oz. (1.2 L) bottle with cap.

18950 Black



TEE SEED AND SOIL CADDIE (WITH HOLDER)

- ▶ Contoured bottle keeps mixture dry.
- ▶ Steel powder-coated holder.
- ▶ Includes decal and 78 oz. (2.3 L) bottle with screw-on cap.

18800 Black
18900 Green

DIVOT MIX STORAGE



ADD YOUR LOGO SEE PAGE 7

BOTTLE STORAGE BOXES

- ▶ Two models/capacities:
 - ▶ 25 – 40 oz. (1.2 L) bottles
 - ▶ 50 – 40 oz. (1.2 L) bottles
- ▶ Stylish heavy-built frame housing.
- ▶ Bottles not included.

25-BOTTLE 24"H x 32"W x 24"D (61 cm x 81 cm x 61 cm)
50-BOTTLE 32"H x 45"W x 25"D (81 cm x 114 cm x 64 cm)

Green	200110GN	200120GN
Brown	200110BR	200120BR
Black	200110BK	200120BK

ADD YOUR LOGO SEE PAGE 7



RECYCLED DIVOT MIX BOTTLE BOX

- ▶ Compact. Portable. Rugged.
- ▶ Bottle storage box holds up to twelve 40 oz. (1.2 L) bottles.
- ▶ Bottles not included.

16"H x 18"W x 13"D (41 cm x 46 cm x 33 cm)

Green	200140GN
Brown	200140BR
Black	200140BK

RECYCLED DIVOT MIX BOTTLE RACK

- ▶ Holds 24-40 oz. (1.2 L) bottles. Comes with 4" x 4" (10 cm x 10 cm) 60" posts (152 cm) for permanent in-ground installations.
- ▶ Convenient leveling feet for placement on surfaces also available upon request for an additional charge.
- ▶ Bottles not included.



60"H x 41"W x 16"D (152 cm x 104 cm x 41 cm)

Green	200130GN
Brown	200130BR
Black	200130BK

DOUBLE DIVOT MIX BOTTLE RACK

- ▶ A must for any golf course.
- ▶ Portable design makes placement easy anywhere on your course.
- ▶ Holds 30-40 oz. (1.2 L) Seed and Soil bottles.
- ▶ Bottles not included.



35"H x 58"W x 18"D (89 cm x 147 cm x 46 cm)

Green	200145GN
Brown	200145BR
Black	200145BK

BULK DIVOT MIX CONTAINERS

- ▶ Large-capacity, heavy-duty containers with hinged lids.
- ▶ Clean, smart styling fits in wherever you place them.
- ▶ SMALL container, approx. 63 ½ gallons (240 L); LARGE container, approx. 117 gallons (443 L).

SMALL 24"H x 34"W x 18"D (61 cm x 86 cm x 46 cm)
LARGE 31"H x 36"W x 24"D (79 cm x 91 cm x 61 cm)

Green	200080GN	200090GN
Brown	200080BR	200090BR
Black	200080BK	200090BK



ADD YOUR LOGO SEE PAGE 7

SEED AND SOIL BOTTLES

- ▶ Contoured design keeps mixture dry, easier to dispense.
- ▶ Select 3 ½" (8.9 cm) and/or 5" (12.7 cm) diameter sizes.

Bottle size: 13" (34 cm) high 3 ½" (8.9 cm) diameter
 18952 40-oz. (1.2 L) Cart Seed and Soil Bottle with Lid

Bottle size: 13" (34 cm) high 5" (12.7 cm) diameter
 18802 78-oz. (2.3 L) Tee Seed and Soil Bottle with Lid

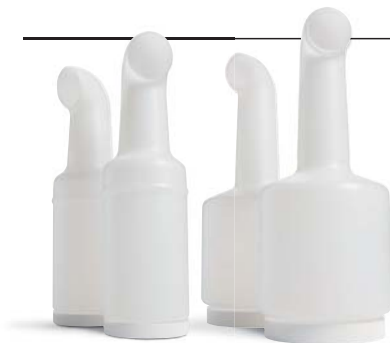

BACK BENCHES

- ▶ Extra comfort for players during slow play.
- ▶ Full back support. Heavy-duty design.

4-FT (1.2 M) BENCH
35"H x 48"W
(89 cm x 122 cm)

6-FT (1.8 M) BENCH
35"H x 72"W
(89 cm x 183 cm)

Green	100200GN	100300GN
Brown	100200BR	100300BR
Black	100200BK	100300BK



ADD YOUR LOGO
SEE PAGE 7

FLAT BENCHES

- ▶ Simple. Rugged. Versatile. Maintenance-free.
- ▶ Great for tees, ranges or anywhere on the course.

4-FT (1.2 M) BENCH
16"H x 48"W
(41 cm x 122 cm)

6-FT (1.8 M) BENCH
16"H x 72"W
(41 cm x 183 cm)

Green	100400GN	100500GN
Brown	100400BR	100500BR
Black	100400BK	100500BK



SCORE CARD CADDIE WITH POST

Perfect for first and second tees, turns or near the clubhouse.

- ▶ Perched on 60" (152 cm) post – 4" x 4" (10 cm x 10 cm).
- ▶ "Scorecards and Pencils" tag included.



60"H x 16 1/2"W x 14 1/2"D
(152 cm x 42 cm x 37 cm)

Green	100180GN
Brown	100180BR
Black	100180BK

ASH TUBE

- ▶ Place around clubhouse and on tees to keep unsightly cigarette butts off grass and in trash.
- ▶ Drainage outlets at bottom expel water.

34 1/2"L x 1 1/4"D (88 cm x 3.2 cm)
5" (13 cm) spike

01700 Ash Tube



All nylon flags made with
DuPont SolarMax
Nylon

400 DENIER VS. 200 DENIER FLAG FACTS:

FACT #1

Sometimes less is more. 400 denier is relatively new to the industry and typically used on sailboats.

FACT #2

The purpose of a golf flag is to show where the cup is, and to help golfers judge wind speed. It takes a 7 to 10 mph wind to get a 400 denier flag waving. It takes a 3 to 5 mph wind to get a 200 denier flag waving. Advantage: 200 denier. Plus, the heavier 400 denier flag wears out a flagstick faster.

FACT #3

Golf flags are meant to fly. Sails are meant to propel sailboats. One has nothing to do with the other. So trust us when we tell you the only time we recommend 400 denier is usually when we're talking to sailors, not superintendents.

BEST WAY TO FLY!

Standard Golf's special quad-stitch process ensures a more durable flag that flies true in any wind. Look at the difference! Four rows of stitching instead of two, and wider edges that reduce wear.

STANDARD GOLF'S
QUADRUPLE-STITCHED
BORDERS

VS.

COMPETITORS' DOUBLE-
STITCHED BORDERS

QUADRUPLE-
STITCHED

QUADRUPLE-
STITCHED

DOUBLE-
STITCHED



1 SCREEN PRINTING

Select your favorite color and style of flag on pages 24-25, then record the product code based on the number of colors you plan to use in your design or logo.

2 CHOOSE NUMBER OF COLORS IN YOUR LOGO

	Set of Nine
One-Color	21011
Two-Color	21021
Three-Color	21031
Four-Color	21041
Five-Color	21051
Six-Color	21061
Seven-Color	21071

1 EMBROIDERY

Select your favorite color and style of flag on pages 24-25; then record product code based on quantities ordered for the style selected.

2 CHOOSE FLAG QUANTITIES

	Non-Checked Styles	Checked Styles
12-35 Flags	21700T	21750T
36-59 Flags	21701T	21751T
60-143 Flags	21702T	21752T

Contact your distributor for exact pricing based on the stitch count.

3 ADDITIONAL OPTIONS

DOUBLE-SIDED CUSTOMIZATION

Screen print or embroider your logo to read correctly on both sides of the flag for unparalleled visibility.

Screen Printing

21375

Embroidery

Call for Specialized Quote

Contact your local distributor for exact pricing based on the stitch count.



INDIVIDUAL NUMBERING

Per Set of Nine

21324 Numbers in 3" (7.6 cm) Circle

21325 Individually Screened Numbers

Specify size of number 3" (7.6 cm), 4" (10.2 cm), 5" (12.7 cm) or 6" (15.2 cm) in height

21326 Appliqued Numbers

Specify size of number 3" (7.6 cm), 4" (10.2 cm), 5" (12.7 cm) or 6" (15.2 cm) in height



4 ONE-TIME ART CHARGES

FOR SCREEN PRINTING

Art charge waived on orders of 4 sets (36 flags) or more with same logo, or if artwork is provided in vector format.

21300 Full Art Charge

One-time charge for logos being printed first time.

21310 Partial Art Charge

For changes in previously printed orders and date changes.

FOR EMBROIDERY

For first-time embroidery projects we will need to digitize your logo to determine exact number of stitches required.

21790 Up to 30,000 Stitches

21791 From 30,000 to 100,000 Stitches

PLAIN FLAGS

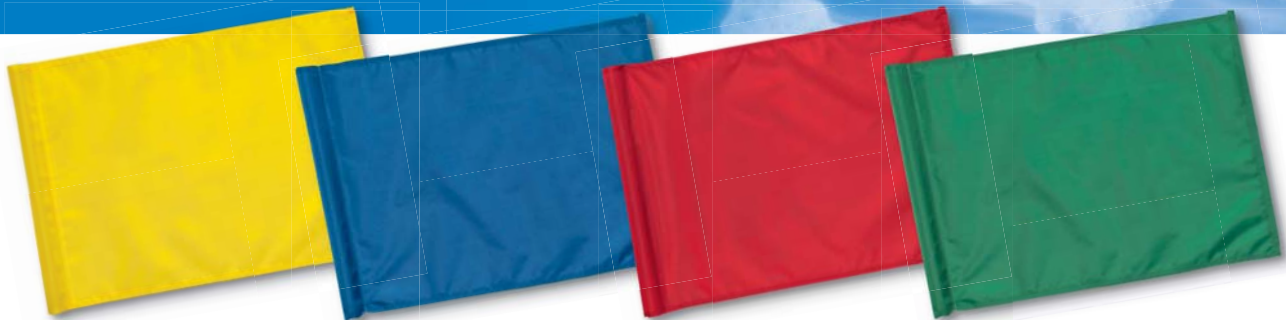

PLAIN FLAGS | DUPONT SOLARMAX NYLON

200 Denier	Grommets	Tube-Lock
Red	22190	22190T
White	22200	22200T
Yellow	22210	22210T
Orange	22220	22220T
Dartmouth	22230	22230T
Spanish Yellow	22240	22240T
Medium Blue	22250	22250T
Dark Blue	22260	22260T
Green	22280	22280T
Light Blue	22340	22340T
Purple	22350	22350T
Brown	22370	22370T
Maroon	22380	22380T
Silver	22390	22390T
Black	22410	22410T
Pink	22420	22420T
Gold	22430	22430T
Beige	22440	22440T
Red/White/Blue (3 each)	22460	22460T

Set of Nine

PLAIN FLAGS | DUPONT SOLARMAX NYLON

400 Denier	Tube-Lock
Red	22190TX
White	22200TX
Yellow	22210TX
Spanish Yellow	22240TX
Medium Blue	22250TX
Green	22280TX
Black	22410TX

Set of Nine

PLAIN FLAGS | HEAVY WEAVE POLYESTER

	Grommets	Tube-Lock
Dark Red	23180	23180T
White	23190	23190T
Yellow	23200	23200T
Dark Blue	23210	23210T

Set of Nine

PLAIN FLAGS | VENTI-KNIT

	Grommets	Tube-Lock
Red	24160	24160T
White	24170	24170T
Yellow	24180	24180T

Set of Nine

FULL BORDER FLAGS | DUPONT SOLARMAX NYLON

► Durable, one-piece 1/2" (1.3 cm) border for stronger, bolder look.

200 Denier	
White/Red	25400T
White/Medium Blue	25350T
White/Dark Blue	25360T
White/Green	25410T
White/Maroon	25380T
White/Black	25310T
White/Dartmouth	25390T
Yellow/Green	25340T
Yellow/Black	25330T
Spanish Yellow/Black	25370T
Red/Black	25300T
Medium Blue/Black	25320T

Set of Nine

TWO-TONE FLAG | DUPONT SOLARMAX NYLON

200 Denier	
White/Red	22700T
White/Medium Blue	22710T
White/Dark Blue	22720T
White/Green	22730T
White/Maroon	22740T
White/Black	22750T
White/Dartmouth	22810T
Yellow/Medium Blue	22760T
Yellow/Green	22770T
Yellow/Black	22780T
Spanish Yellow/Black	22820T
Red/Black	22790T
Medium Blue/Black	22800T

Set of Nine



MADE TO ORDER
 Don't see exactly what you want in this catalog? No problem. Call today and ask about customizing your flag order.

NUMBERED FLAGS | DUPONT SOLARMAX NYLON

200 Denier	Grommets		Tube-Lock	
	1-9	10-18	1-9	10-18
2 White/Red	22111	22110	22111T	22110T
2 White/Medium Blue	22141	22140	22141T	22140T
2 White/Green	22161	22160	22161T	22160T
2 White/Black	22181	22180	22181T	22180T
2 Yellow/Red	22931	22930	22931T	22930T
2 Yellow/Medium Blue	22941	22940	22941T	22940T
2 Yellow/Green	22951	22950	22951T	22950T
2 Yellow/Black	22121	22120	22121T	22120T
2 Red/Black	22911	22910	22911T	22910T
2 Red/White	22101	22100	22101T	22100T
2 Medium Blue/Black	22921	22920	22921T	22920T
2 Medium Blue/White	22151	22150	22151T	22150T
2 Orange/Black	22131	22130	22131T	22130T
2 Green/White	22171	22170	22171T	22170T

Set of Nine

NUMBERED FLAGS | HEAVY WEAVE POLYESTER

	1-9		10-18	
2 Red/White	23101T		23100T	
2 White/Red	23111T		23110T	
2 Yellow/Black	23121T		23120T	

Set of Nine

NUMBERED FLAGS | VENTI-KNIT

	Grommets		Tube-Lock	
	1-9	10-18	1-9	10-18
2 Red/White	24101	24100	24101T	24100T
2 White/Red	24111	24110	24111T	24110T
2 Yellow/Black	24121	24120	24121T	24120T

Set of Nine



SEMAPHORE & PENNANTS | DUPONT SOLARMAX NYLON

► Dual numbered flags are ideal for nine-hole courses.

200 Denier Semaphore	Grommets	Tube-Lock
Red/White	22300	22300T
Black/White	22400	22400T
Med Blue/White	22450	22450T
Green/White	22470	22470T
Black/Yellow	22480	22480T

Set of Nine

Dual Numbered Semaphore (1-10 through 9-18)	Grommets	Tube-Lock
Red/White	22310	22310T

Set of Nine

Pennant	Grommets	Tube-Lock
White/Red	22290	22290T

Set of Nine

SEWN CHECKERED FLAGS | DUPONT SOLARMAX NYLON

► Finish it off with your club logo inside our open-center design.

200 Denier	Checked	Open-Center
Red/White	22630T	22630TP
Med Blue/White	22640T	22640TP
Green/White	22650T	22650TP
Dartmouth/White	22680T	22680TP
Yellow/White	22660T	22660TP
Black/White	22330T	22330TP
Black/Red	22610T	22610TP
Black/Med Blue	22620T	22620TP
Black/Yellow	22320T	22320TP
Red/Yellow	22690T	22690TP
Med Blue/Yellow	22670T	22670TP
Green/Yellow	22580T	22580TP
Dartmouth/Yellow	22590T	22590TP
Pink/White	22570T	22570TP

Set of Nine



CUSTOMIZED FLAGS & PRACTICE GREEN FLAGS

INTRODUCING

FULL COVERAGE FLAGS

- ▶ Golf flags like you have never seen them before! Any color and any pattern!
- ▶ Photo-quality color flags with mirror image printing.

NEW!



▲ Full vibrant color on both sides



▲ Image is mirrored on the back

To order add an F to the end of the dye sub part numbers. An additional fee will be added. Contact your distributor for more information.



CUSTOMIZED FLAGS

- ▶ NOW available with full coverage graphics!
- ▶ Revolutionary, state-of-the-art dye sublimation process.
- ▶ Full-color printing capabilities create photo-quality logo reproduction.
- ▶ More versatile and economical when compared to traditional screen printed or embroidery processes.
- ▶ Maximum UV-resistant material helps maintain long-lasting color.
- ▶ Exclusive quadruple-stitched edges extend flag life.
- ▶ Your choice of two fabrics – white heavy-weave polyester for the feel of cotton or the nylon-like feel of the tight-weave white polyester material.



	Grommets Set of Nine	Grommets Single	Tube-Lock Set of Nine	Tube-Lock Single
Customized 250 Denier White Polyester	25750	25752	25750T	25752T
Customized Heavy-Weave White Polyester	25850	25852	25850T	25852T

Minimum order of nine.

Each flag design can be individually customized, available in white only.

PRACTICE GREEN FLAGS

	SMALL TUBE SET OF NINE Fits 3/8" (1.0 cm) Rod	SMALL TUBE SINGLE Fits 3/8" (1.0 cm) Rod	LARGE TUBE SET OF NINE Fits 1/2" (1.3 cm) Rod	LARGE TUBE SINGLE Fits 1/2" (1.3 cm) Rod
Customized 250 Denier White Practice Green	25900	25902	25950	25952

Minimum order of nine.

Each flag design can be individually customized, available in white only.



EVENT FLAGS | POLYESTER

- ▶ Rich, full color, photo-quality reproduction.
- ▶ Every flag can be customized at no additional cost!
- ▶ Simply email your artwork to art@standardgolf.com to see if you qualify for FREE artwork setup or better yet give us a call.
- ▶ Economical. Versatile. Vibrant.
- ▶ Cloth tube design lays flat; ideal for framing.
- ▶ Available on white polyester only.
- ▶ Designed for use in events. Limited 30-day warranty.



**IF YOU CAN DESIGN IT,
WE CAN REPRODUCE IT.**

19 7/8" x 13 7/8" (50.5 cm x 35.2 cm)

Set of Nine

Single

Customized Event Flag

25650

25652

Minimum order of nine.

Each event flag design can be individually customized.

FLAGS FOR PRACTICE GREENS

PLAIN PRACTICE GREEN FLAGS

- ▶ Now available in ½" (1.3 cm) size to fit Junior Tournament practice green rods and Par-Aide practice green rods.
- ▶ Customize them with your logo. (See below.)
- ▶ Made with Dupont SolarMax nylon.

	SMALL TUBE Fits ¾" (1.0 cm) Rod	LARGE TUBE Fits ½" (1.3 cm) Rod
Green	20595	20597
Red	20695	20697
White	20795	20797
Yellow	20895	20897
Blue	20995	20997

Per Set of Nine



CHECKERED PRACTICE GREEN FLAGS

- ▶ For a classier, more distinctive look.
- ▶ Now available in ½" (1.3 cm) size to fit Junior Tournament practice green rods and Par-Aide practice green rods.
- ▶ Made with Dupont SolarMax nylon.

	SMALL TUBE Fits ¾" (1.0 cm) Rod	LARGE TUBE Fits ½" (1.3 cm) Rod
Black/White	20910	20915
Red/White	20920	20925
Black/Yellow	20930	20935
Green/White	20940	20945

Per Set of Nine



CUSTOMIZED PRACTICE GREEN FLAGS

- ▶ Revolutionary, state-of-the-art dye sublimation process.
- ▶ Full-color printing capabilities create photo-quality logo reproduction.
- ▶ Maximum UV-resistant material helps maintain long-lasting color.
- ▶ More versatile and economical when compared to traditional screen printed or embroidery processes.
- ▶ Available in ¾" (1.0 cm) and ½" (1.3 cm) sizes to fit Standard Golf and Par-Aide practice green rods.



**NOW AVAILABLE!
FULL COVERAGE GRAPHICS!**

To order add an F to the end of the dye sub part numbers. An additional fee will be added. Contact your distributor for more information.

	SMALL TUBE SET OF NINE Fits ¾" (1.0 cm) Rod	SMALL TUBE SINGLE Fits ¾" (1.0 cm) Rod	LARGE TUBE SET OF NINE Fits ½" (1.3 cm) Rod	LARGE TUBE SINGLE Fits ½" (1.3 cm) Rod
Customized 250 Denier White Practice Green	25900	25902	25950	25952

Minimum order of nine.
Each flag design can be individually customized,
available in white only.

EMBROIDERED PLAIN PRACTICE GREEN FLAGS

- ▶ The elegance of embroidery with UV-resistant, color-fast threads for lasting brightness.
- ▶ Includes set of nine plain practice green flags.

Set of Nine

Set-up Charge	20990
Up to 8,000 Stitches	20950
Over 8,000 Stitches	Call for quote



PRACTICE GREEN FLAGS SCREEN PRINTING CHARGES

- ▶ From one color to seven colors. Available on plain flags only.
- ▶ Charge does not include base flag cost.

21300 One-time Art Charge

Set of Nine

One-Color	20901
Two-Color	20902
Three-Color	20903
Four-Color	20904
Five-Color	20905
Six-Color	20906
Seven-Color	20907



PLACEMENT FLAGS

- ▶ Slide up or down to indicate hole position. And remind players to "Please Repair Ball Marks". (English only.)
- ▶ Placement Flags fit flagsticks up to 3/4" (1.9 cm) diameter.
- ▶ Rubber grommets included.
- ▶ Made with Dupont SolarMax nylon.



	PLEASE REPAIR BALL MARKS		PLAIN (NO MESSAGE)	
	1/2" (1.3 cm) flagstick	3/4" (1.9 cm) flagstick	1/2" (1.3 cm) flagstick	3/4" (1.9 cm) flagstick

Red	05335	05337	05345	05347
Yellow	05355	05357	05365	05367
White	-	-	05371	05372

Set of Nine

Note: Personalized placement flags also available.



PLACEMENT MARKERS

- ▶ Placement Markers fit flagsticks 1/2" (1.3 cm) diameter only.
- ▶ Rubber grommets included.

Red	05350
White	05351
Blue	05352
Yellow	05353



BUDGET FLAGS

- ▶ Ideal for temporary greens, early/late-season flags and tight budgets.
- ▶ Cloth tube design makes installation easy.
- ▶ Limited 30-day warranty.
- ▶ Personalization not available.

	Set of Nine	Single
White	25600	25602
Red	25610	25612
Yellow	25620	25622
Blue	25630	25632



RUBBER GROMMETS

1/2" (1.3 cm) Flagstick	05354
3/4" (1.9 cm) Flagstick	05360



SWIVELS

- ▶ For grommeted flags. Choose the swivel that's most convenient — wire or Snap-Lock.
- ▶ For easy flag changing, use our handy Snap-Lock swivel.

26316	Wire Swivel
26322	Snap-Lock Swivel

Not included with flagsticks. Must be ordered separately.



AMERICAN AND CANADIAN GOLF FLAGS

- ▶ Put your nation's flag on display during the next holiday.
- ▶ For practice greens, please order rods, knobs and bases separately.



20" x 14" (51 cm x 36 cm)

22466T Sewn U.S. Flag Replica – For Flagstick

25500T Canadian Flag Replica – For Flagstick

Set of Nine

5 1/2" x 8" (14 cm x 20 cm) Only fits 3/8" (1.0 cm) practice green rods.

20985 Sewn U.S. Flag Replica – For Practice Green

Set of Nine

AMERICAN FLAG

- ▶ Rugged two-ply polyester American flags.
- ▶ Four sizes for clubhouse and grounds.



21900 3'H x 5'W (91 cm x 152 cm)

21901 4'H x 6'W (122 cm x 183 cm)

21902 5'H x 8'W (152 cm x 244 cm)

21903 6'H x 10'W (183 cm x 305 cm)

IF IT STICKS, TWISTS OR LEANS

IT'S TIME TO SWITCH!

- ▶ Patented solution for pre-mature wear.
- ▶ Notched-ferrule flagsticks fall right into place every time.
- ▶ Sturdy, gusset-reinforced ribs allow dirt and sand to freely sift through the cup to eliminate sticking.

*See page 15 for more information on ST2000 Cups.

WATCH IT
WORK!



www.standardgolf.com

THE SMART-FIT FERRULE

If it doesn't mesh with the cup, it twists. If it twists, it wears out. If it wears out, it leans. And if it leans, it shows.

- ▶ 16 tapered flanges seat the ferrule and flagstick perfectly with the Smart-Fit Cup ... EVERY TIME.
- ▶ Comes standard on all flagstick orders and works great on all styles of cups.

26515 SMART-FIT Ferrule



SMART-FIT Ferrule

TRADITIONAL FERRULE

26517 Traditional Ferrule



Traditional Ferrule

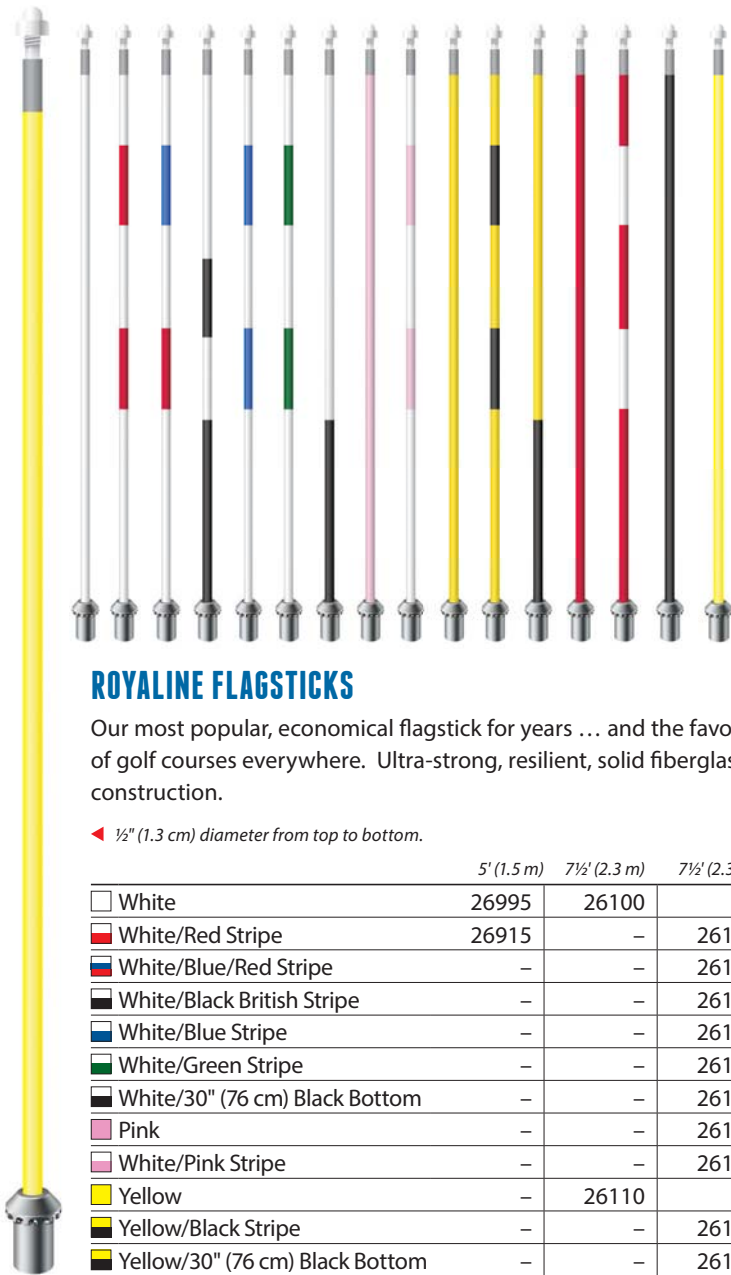

ROYALINE FLAGSTICKS

Our most popular, economical flagstick for years ... and the favorite of golf courses everywhere. Ultra-strong, resilient, solid fiberglass construction.

◀ ½" (1.3 cm) diameter from top to bottom.

	5' (1.5 m)	7½' (2.3 m)	7½' (2.3 m)
White	26995	26100	-
White/Red Stripe	26915	-	26101
White/Blue/Red Stripe	-	-	26102
White/Black British Stripe	-	-	26103
White/Blue Stripe	-	-	26104
White/Green Stripe	-	-	26105
White/30" (76 cm) Black Bottom	-	-	26106
Pink	-	-	26107
White/Pink Stripe	-	-	26108
Yellow	-	26110	-
Yellow/Black Stripe	-	-	26111
Yellow/30" (76 cm) Black Bottom	-	-	26112
Red	-	26120	-
Red/White Stripe	-	-	26121
Black	-	26130	-
Optic Yellow	-	26140	-

	8' (2.4 m)	10' (3 m)
White	26998	26990*
Yellow	26988	26980*

*Cannot ship UPS/FedEx



TOURNAMENT FLAGSTICKS

Take advantage of the remarkable strength, visibility and wind resistance of the Tournament Flagstick. Extra left in the center for added performance on greens.

◀ ½" (1.3 cm) diameter at both tip and ferrule;
¾" (1.9 cm) diameter at the center.

	7½' (2.3 m)	7½' (2.3 m)
White	26300	-
White/Black British Stripe	-	26301
White/Red British Stripe	-	26302
White/Green British Stripe	-	26303
White/30" (76 cm) Black Bottom	-	26304
Yellow	26310	-
Yellow/Black British Stripe	-	26311
Yellow/30" (76 cm) Black Bottom	-	26314

DON'T
SEE
EXACTLY
WHAT YOU
WANT?



Then let us build it for you. Call us and we will help you get what you want.



FLAGSTICK CADDIE

- ▶ Keep up to 18 flagsticks free of nicks, dings and other damage during transport.
- ▶ Solid steel, powder-coated caddy with cushioned foam slots to grip and protect flagsticks.
- ▶ Vertical arm slips into stake-hole pocket of most golf utility vehicles (alternative brackets available); removes quickly and easily when not in use.
- ▶ Junior Flagstick Caddy holds up to six flagsticks.
- ▶ Flagstick Caddy is not compatible with Tournament Flagsticks.

25000 Flagstick Caddy (Two Pieces)

25100 Junior Flagstick Caddy (Two Pieces)

25001 Alternative Bracket (Two Pieces)

25002 Replacement Flagstick Holder



EASYMARK SYSTEMS

- ▶ Put a flagstick anywhere, without cutting a cup hole.
- ▶ EasyMark for 0.5" (1.3 cm) non-ferruled flagsticks.
- ▶ EasyMark II for ferruled flagsticks.
- ▶ Versatile tap-in anchor makes it easy to set up flags for special events or on the range.

EasyMark: 6" (15 cm) long 3" (7.6 cm) diameter

Rod: 5' (152 cm) high 1/2" (1.3 cm) diameter

26760 EasyMark II

26755 EasyMark

26750 EasyMark with Rod



LASER REFLECTOR

- ▶ Easily replaces acorn nut on Standard, Par Aide, and all other flagsticks with 3/8" - 24 threaded tip.
- ▶ Features nylon threads. No more metal-on-metal seizing associated with brass inserts.
- ▶ New five-glass prism pod design maximizes reflectivity, leaving no dead spots.
- ▶ Prisms snap into place for extra durability.



The Laser Reflector screws easily onto the tip of a flagstick, replacing the acorn nut.

1 1/16" H x 3/8" W (4.3 cm x 2.2 cm)

26600 Laser Reflector

FLAGSTICK STAND

- ▶ Perfect for displaying flagsticks indoors.
- ▶ Powder-coated steel for increased durability.
- ▶ Stand can be mounted for temporary or permanent use.



2 1/4" H x 7 1/2" diameter (6 cm x 19.1 cm)

26800 Flagstick Stand

SWIVELS

- ▶ For grommeted flags, choose the swivel that's most convenient — wire or Snap-Lock.
- ▶ For easy flag changing, use our handy Snap-Lock swivel.

26316 Wire Swivel

26322 Snap-Lock Swivel

Not included with flagsticks.

Must be ordered separately.

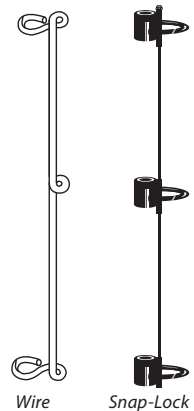

Wire

Snap-Lock

ALL-FLEX

HAZARD MARKERS



**WATCH IT
WORK!**



www.standardgolf.com

ALL-FLEX HAZARD/YARDAGE MARKERS

- ▶ Ground-breaking design allows markers to be run over in any direction without damage.
- ▶ Super-tough polyurethane joint for maximum flex.
- ▶ Replaceable, UV-resistant polycarbonate sleeve for added protection.
- ▶ Ground anchor sold separately.
- ▶ Not intended for use on fairways.
- ▶ Priced individually. Sold in multiples of twelve.

19" (48 cm) long, plus 7" (18 cm) spike

<input type="checkbox"/> White	15000
<input type="checkbox"/> Yellow	15100
<input type="checkbox"/> Red	15200
<input type="checkbox"/> Blue	15300
<input type="checkbox"/> Purple	15400

ALL-FLEX GROUND ANCHOR

- ▶ Install All-Flex ground anchor flush to the ground.

7 3/8" (19 cm) long

15500 Ground Anchor



HAZARD MARKERS

NEW!



DIRECTIONAL STAKES

- ▶ Markers used to direct golfers around sensitive areas.
- ▶ 6 ¼" (15.9 cm) white recycled plastic stakes with a 4" (10 cm) green, blue, red or yellow vinyl cap.
- ▶ 5 ¾" (14.6 cm) coated steel spike.
- ▶ Round 1½" (3.8 cm) diameter
- ▶ Sold in quantity of 25, includes a black carrying bucket.

6 ¼" (15.9 cm) long, plus 5 ¾" (14.6 cm) spike

Yellow	16925
Green	16935
Red	16950
Blue	16975



PREMIUM GREEN LINE HAZARD STAKES

- ▶ Premium recycled plastic stakes feature a decorative beveled top and rich, vibrant UV-resistant colors.
- ▶ 5 ½" (14 cm) zinc coated hardened steel spike makes it easy for players to remove and replace.
- ▶ Purple stakes used to designate reclaimed/recycled water.
- ▶ Priced individually. Sold in multiples of twelve.

	12" (30 CM) SQUARE with spike	18" (46 CM) SQUARE with spike	24" (61 CM) SQUARE with spike	24" (61 CM) SQUARE with spike
5½" (14 cm) spike				
White	17012	17018	17024	–
Yellow	17112	17118	17124	–
Red	17212	17218	17224	–
Blue	17312	17318	17324	–
Purple	–	–	–	17424



RECYCLED PLASTIC HAZARD MARKERS - WITH SPIKES

- ▶ Molded with UV-resistant colors; won't crack, rot or absorb moisture.
- ▶ 5" (13 cm) steel spike makes it easy for players to remove and replace.
- ▶ Priced individually. Sold in multiples of twelve.



5" (13 cm) spike
Round: 1 1/2" (3.8 cm) diameter

	24" (61 CM) SQUARE with spike	24" (61 CM) ROUND with spike
White	16400	16600
Yellow	16425	16625
Red	16450	16650
Blue	-	16675

RECYCLED PLASTIC HAZARD MARKERS - REMOVABLE

- ▶ Secure in a fixed position with PVC ground anchors (sold separately).
- ▶ Ideal for more permanent placements (O.B.); easy to remove and mow.
- ▶ Molded with UV-resistant colors; won't crack, rot or absorb moisture.
- ▶ Priced individually. Sold in multiples of twelve.



Round: 1 1/2" (3.8 cm) diameter

	24" (61 CM) SQUARE	32" (81 CM) ROUND
White	16500	16700
Yellow	16525	16725
Red	16550	16750
Blue	-	16775

PVC HAZARD MARKERS - WITH SPIKES

- ▶ Economical. Virtually unbreakable.
- ▶ Includes end cap and 4 1/2" (11 cm) steel spike.
- ▶ Priced individually. Sold in multiples of twelve.



4 1/2" (11 cm) spike
Round: 1 1/2" (3.8 cm) diameter

	25" (61 CM) ROUND with spike
White	16200
Yellow	16225
Red	16250

PVC HAZARD MARKERS - REMOVABLE

- ▶ Remove and mow right over ground anchor (sold separately).
- ▶ Virtually unbreakable. UV-resistant colors. Includes end caps.
- ▶ Priced individually. Sold in multiples of twelve.



Round: 1 1/2" (3.8 cm) diameter

	32" (81 CM) ROUND without spike
White	16101
Yellow	16126
Red	16151

Order ground anchors and driving tools separately from markers.

GREEN END CAPS

- ▶ Indicate environmentally-sensitive hazards by replacing regular caps on PVC markers.



16153 Green Cap for PVC Hazard Markers

PVC GROUND ANCHORS

Round: 7" (18 cm) long
Square: 4" (10 cm) long

16157	Round
16575	Square



DRIVING TOOL

48" (122 cm) long
16158 Round



HOLE CUTTERS & SHELLS

MAGNUM HOLE CUTTER

- ▶ Year-after-year our most popular model.
- ▶ Field-tested and proven in all soils ... with flying colors.
- ▶ Smooth lever action.
- ▶ Full selection of cutter shells to match your conditions.

4 1/4" (10.8 cm) diameter

28960 Straight Shell
sharpened inside

28970 Scalloped Shell
sharpened inside

28980 Scalloped Shell
sharpened outside

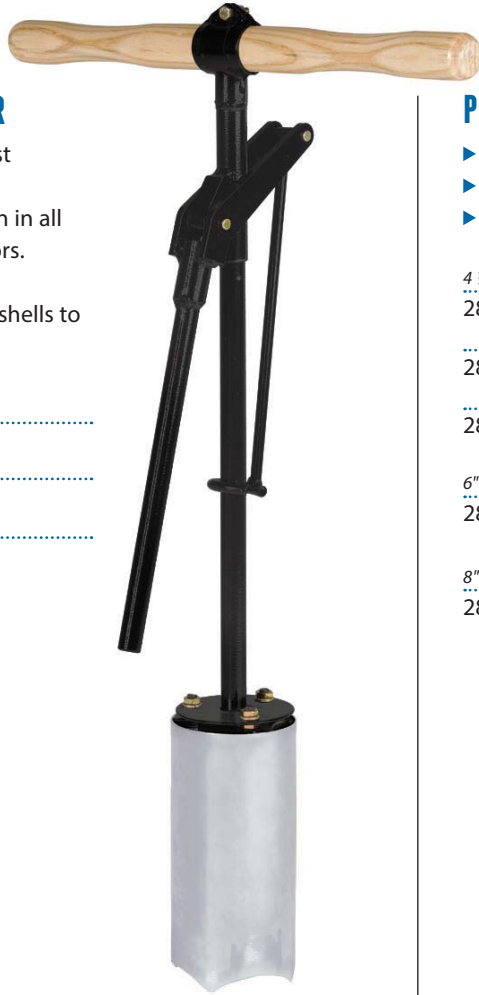

PRO II HOLE CUTTER

- ▶ Simple, economical and ready to cut.
- ▶ Hot-rolled tubing. Carbon steel shaft.
- ▶ Adjustable depth collar. Foot ejector.

4 1/4" (10.8 cm) diameter

28700 Straight Shell
sharpened inside

28800 Scalloped Shell
sharpened inside

28801 Scalloped Shell
sharpened outside

6" (15.2 cm) diameter

28775 Straight Shell
sharpened inside

8" (20.3 cm) diameter

28785 Straight Shell
sharpened inside

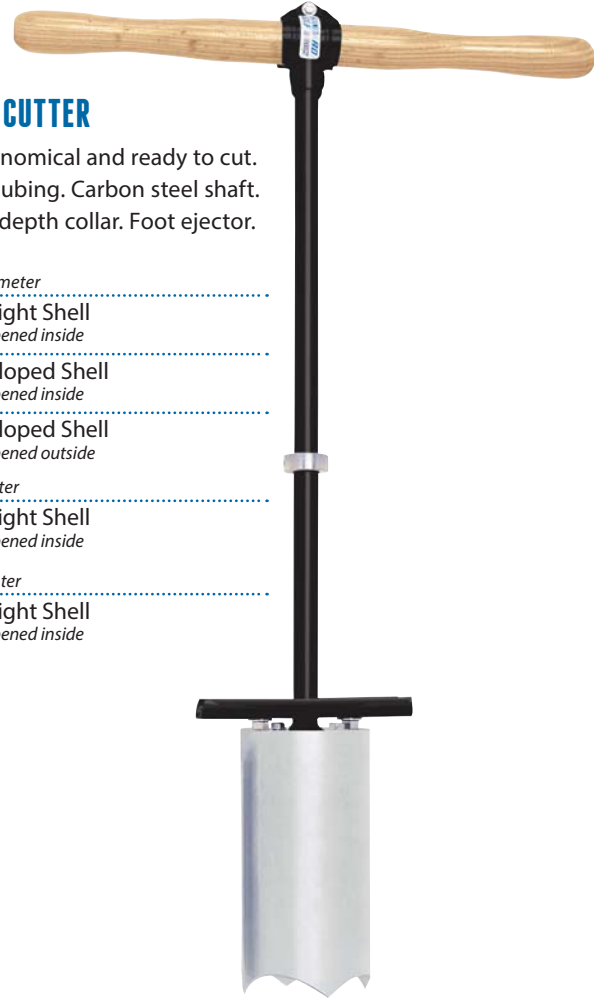

REPLACEMENT SHELLS

Standard Golf recommends inside sharpened cutting blades primarily for sand greens. They pack the sand tighter and hold it more firmly in place.

Trouble disengaging plugs? Spend just a few minutes sanding the inside of the blade with emery paper. You'll be amazed at how much easier it is to unplug.



Straight Shell



Scalloped Shell



Side-Mounted Inside Scalloped Shell

◀ Replacement shell for Par Aide hole cutters

	4 1/4" (10.8 CM)	6" (15.2 CM) Pro II Only	8" (20.3 CM) Pro II Only
Inside Sharpened Straight Shell	28927	28777	28787
Inside Sharpened Scalloped Shell	28952	-	-
Outside Sharpened Scalloped Shell	28953	-	-
Inside Sharpened Scalloped Shell (for side-mounted hole cutters)	28990	-	-

HOLEMASTER HOLE CUTTER

Cutting into hard soil greens? Make it cleaner and easier.

- ▶ Durable, outside sharpened case-hardened blades reinforced with webs and backing plates.
- ▶ Side pins lock in shell for easy extraction, rubber mallet drives blade halves home.
- ▶ U.S. Patent #7,188,113. Foreign patent pending.

4 1/4" (10.8 cm) diameter 2 blades per unit.

28350 Holemaster Hole Cutter

28102 Rubber Mallet

28352 Replacement Blade (2 required per unit)

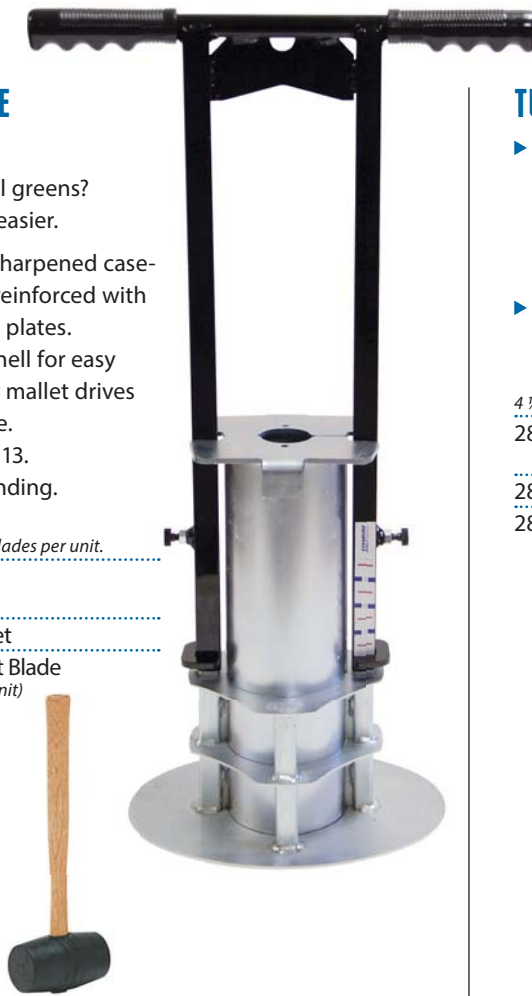

TURFMASTER HOLE CUTTER

- ▶ Razor-sharp outside sharpened blades prevent soil compaction and minimize impact on the putting surfaces and fragile root systems.
- ▶ Use rubber mallet to drive in the blade halves.

4 1/4" (10.8 cm) diameter 2 blades per unit.

28000 Turfmaster Hole Cutter

28102 Rubber Mallet

28002 Replacement Blade (2 required per unit)

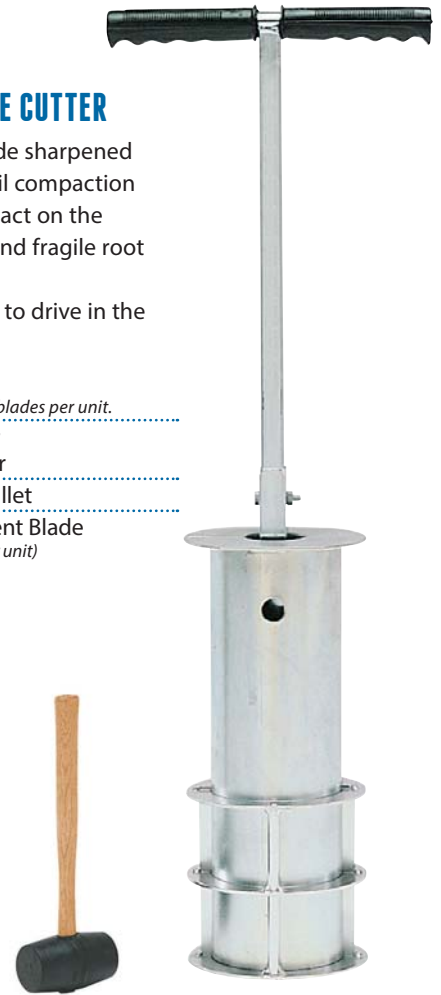

HOLE CUTTER GUIDE

- ▶ Get precision-cut holes every time ... with less stress on turf from twisting feet and aggressive cutting action.
- ▶ Rugged, lightweight, powder-coated aluminum base ... the ideal platform for safe, efficient cuts.



28500 Hole Cutter Guide



SHARPENER

- ▶ Keep shells sharp for easier cuts and precision-cut hole edges.
- ▶ Works with scalloped or straight cutter styles – inside or outside.

28400 Sharpener



DEPTH GAUGE

- ▶ Ensure consistent, accurate cuts with Magnum or Pro II Hole Cutters.

Fits 4 1/4" (11 cm) shells

28600 Depth Gauge



THE MAGNUM LINE ... EXCLUSIVELY FROM

STANDARD GOLF

MAGNUM MAINTENANCE RAKE (STRAIGHT TOOTH)

- ▶ Multi-functional. Designed for construction and repair.
- ▶ Robust rake head design; four different sizes.
- ▶ Long teeth tackle grading. Straight edge handles leveling.
- ▶ 66" (168 cm) straight handle.

71124	24" (61 cm) Head
71130	30" (76 cm) Head
71136	36" (91 cm) Head
71142	42" (107 cm) Head



TWIST AND GUSSET BRACING

Serious strength ... for rough ground and hard knocks. Reinforced to eliminate head-to-handle wobble.

THE TOOLS YOU NEED WHEN YOU NEED TOOLS THAT LAST

An indispensable alternative to a disposable world.

Magnum Tools never die. (You may need to repair them occasionally, but you'll never want to replace them.)

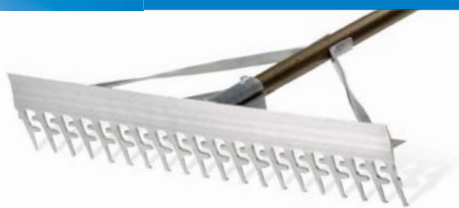

MAGNUM LANDSCAPE RAKE (SIFTING TOOTH)

- ▶ Sifting teeth separate stone and debris; flips over for straight edge leveling.
- ▶ 66" (168 cm) straight handle.

71224	24" (61 cm) Head
71230	30" (76 cm) Head
71236	36" (91 cm) Head
71242	42" (107 cm) Head



MAGNUM DOUBLE DUTY RAKE

- ▶ Long teeth for raking. Short teeth for scarifying.
- ▶ 36" (91 cm) wide workhorse with heavy-duty head.
- ▶ 66" (168 cm) straight handle.

71836	Magnum Double Duty Rake
-------	-------------------------



MAGNUM STRAIGHT-EDGE SQUEEGEE

- ▶ Keep shop floors dry. Remove cart path puddles with ease.
- ▶ Twist and gusset bracing for long life.
- ▶ 66" (168 cm) straight handle.

72224	24" (61 cm) Head
72236	36" (91 cm) Head



MAGNUM LUTE

- ▶ Top-dresses smaller areas. Clears aeration plugs from greens and tees.
- ▶ Reversible blade lets you push or pull material.
- ▶ 66" (168 cm) straight handle.

71424	24" (61 cm) Head
71436	36" (91 cm) Head

MAGNUM SPIKE ROLLER

- ▶ Prepares fine turf for light overseeding. Breaks up moss and algae. Lightly aerates bentgrass greens and tee boxes.
- ▶ Polypropylene roller with fine 7/16" (1.1 cm) spikes.
- ▶ Stainless steel axles. Heavy-duty bolts and lock washers. Industrial-grade end caps.

57 1/2" (146 cm) ergonomically angled handle.

71708	8" (20 cm) Head
71716	16" (41 cm) Head



MAGNUM ROLLER SQUEEGEE

- ▶ Designed for turf or hard surfaces.
- ▶ Double brace system for maximum downward pressure.
- ▶ Efficient, non-absorbent foam rubber head.
- ▶ Stainless steel axle, heavy-duty bolts and lock washers and industrial-grade end caps.

57 1/2" (146 cm) ergonomically angled handle.

71324	24" (61 cm) Head
71336	36" (91 cm) Head
71348	48" (122 cm) Head



REPLACEMENT ROLLER

71325	24" (61 cm) Head
71337	36" (91 cm) Head
71349	48" (122 cm) Head



MAGNUM GENERAL PURPOSE BROOM

- ▶ For everyday cleanup.
- ▶ Reinforced head/handle design.
- ▶ Ergonomically-angled 57 1/2" (146 cm) handle.
- ▶ 24" (61 cm) head.

72100 Magnum General Purpose Broom



MAGNUM MAXIMUM DUTY BROOM

- ▶ 28" (71 cm) all-aluminum head with twist and gusset bracing.
- ▶ Scrape edge removes caked-on material.
- ▶ To soften brush action, simply remove one row of bristles.
- ▶ Ergonomically angled 57 1/2" (146 cm) handle.

72125 Magnum Maximum Duty Broom



SPRING BRACE RAKE

- ▶ Heavy-duty spring keeps all 24 teeth close to the ground.
- ▶ Heavy-duty tines are braced for consistent raking action.
- ▶ 54" (137 cm) powder-coated aluminum handle with grip.
- ▶ 24" (61 cm) head.

72400 Spring Brace Rake

MAGNUM TOOL RACK

- ▶ Get a REAL tool rack that lasts!
- ▶ Heavy-duty, powder-coated in white.
- ▶ Rugged welded tubular channel holds heaviest tools.

74000 12" (31 cm) Magnum Tool Rack

74100 24" (61 cm) Magnum Tool Rack



24" (61 cm) Model

12" (31 cm) Model

BUNKER DEBRIS SIEVE

- ▶ The easy way to sift sand to remove bunker debris and stones.
- ▶ 19" (48 cm) head; 72" (183 cm) handle.



29325 1/2" (1.3 cm) Openings

29350 1/4" (0.6 cm) Openings

TUFFORK

- ▶ Great for spreading mulch or picking up heavy unsightly grass clippings.
- ▶ 54" (137 cm) handle.

71900 Tuffork



MAGNUM MONSTER BROOM

- ▶ Perfect for removing dew or worm casts from greens and tees.
- ▶ Makes short work of shop floors and tennis courts.
- ▶ Two rows of replaceable bristles — mounted to a giant 84" (213 cm) head with 40" (102 cm) handle.
- ▶ Soften broom action by simply removing a row of bristles.

72150 Magnum Monster Broom



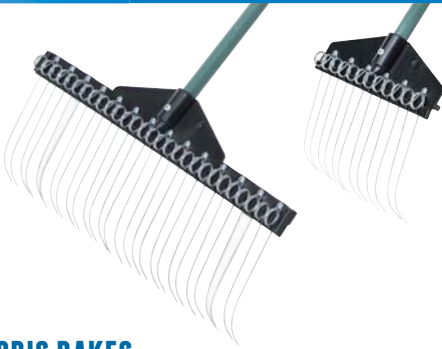

DEBRIS RAKES

- ▶ Great for removing pine needles and as a replacement for traditional bunker rakes.
- ▶ Gusseted head adds extra strength for demanding locations such as waste areas.
- ▶ 9" (23 cm) rake is perfect for maintaining between shrubs, flower beds or any other tight area.
- ▶ Mounts to 60" (152 cm) padded fiberglass handle for maximum strength, reach and comfort.

Priced individually. Sold in multiples of two.

11300 21" (53 cm) Debris Rake

11350 9" (23 cm) Debris Rake

LEVELAWN

- ▶ Distributes application materials.
- ▶ Removes stones from soil, breaks up small clods of sand or loam.
- ▶ Smooths soil for easy planting.



72" (183 cm) handle

29300 30" (76 cm) Levelawn

29375 36" (91 cm) Levelawn



MAGNUM SHOVELS

It's a fact ... cheap shovels end up costing you more.

- ▶ Select round-point, square-point or tapered drain models.
- ▶ 14-gauge tempered steel blades.
- ▶ Solid fiberglass core extends full 12" (30 cm) into handle.
- ▶ Steel collar ring connects shovel neck, handle and core.
- ▶ Thick, extra-long handles and D-grips mean better handling, more comfort, less strain.

	48" (122 CM) black fiberglass handle	27" (69 CM) black fiberglass D-grip handle
Round Point Shovel	71600	71625
Square Point Shovel	71650	71675
Drain Spade	-	71500

HEAVY-DUTY IRRIGATION HEAD TRIMMER

- ▶ Trim thick grasses – even remove roots – around irrigation heads or yardage markers.
- ▶ One handle works with a wide range of head sizes.
- ▶ Plated-steel construction.
- ▶ Trimmer head dimensions are outside diameters.

Order handle and head separately.

29900 Handle Only

29905 5" (12.7 cm) Head Only

29906 6" (15.2 cm) Head Only

29907 7" (17.8 cm) Head Only

29908 8" (20.3 cm) Head Only

29909 9" (22.9 cm) Head Only

29910 10" (25.4 cm) Head Only

29911 11" (27.9 cm) Head Only

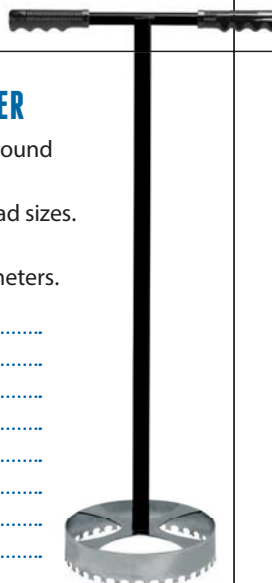

IRRIGATION HEAD TRIMMER

- ▶ One-time adjustable cutting blade (additional replacement blades available).
- ▶ Heavy-built with polished, stainless steel construction.

32" (81 cm) handle

29600 Irrigation Head Trimmer

29601 Replacement Blade



SOIL PROFILE SAMPLER

- ▶ Quickly pull a clean root zone sample.
- ▶ Check roots in fine turf areas.
- ▶ Steel construction. Zinc-plated, case-hardened blade.
- ▶ 8"H x 4"W x 3/4"D (20 cm x 10 cm x 2 cm) samples.

29400 Soil Profile Sampler



HEXAGON TURF REPAIR TOOL

- ▶ Innovative plug design for easy sod/soil removal and seamless replacement.
- ▶ Six-sided plugs pull wedges that are 7"W x 4"D (18 cm x 10 cm).

29225 Hexagon Turf Repair Tool



TURF DOCTOR

- ▶ Invisible sod replacement!
- ▶ Finish patch areas without leaving holes or gaps (i.e., irrigation repair).
- ▶ Razor-sharp blades (4) secure 9" (23 cm) square-cut, wedge-shaped sod blocks that fit and butt perfectly.

29200 Turf Doctor



HAND AERIFIER

- ▶ Choose solid or hollow tines; 2 1/4" (5.7 cm) penetration.
- ▶ Rugged steel construction. Core collector is built right into the base.
- ▶ 3" x 3/8" (7.6 cm x 0.95 cm) replaceable tines on 2" (5 cm) centers.

Order body assembly and tine base assembly separately.

29808 Body Assembly Only

29803 Hollow Tine Base Assembly

29805 Solid Tine Base Assembly

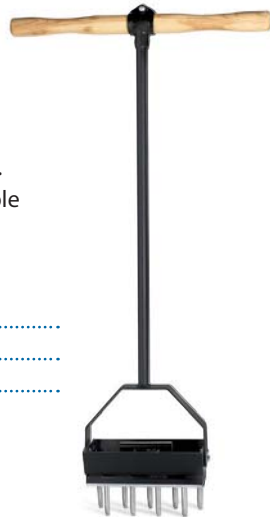

8" (20.3 CM) PRO II HOLE CUTTER/REPAIR TOOL

- ▶ Made for installing 8" (20.3 cm) special event cups, and perfect for quick and easy turf repairs.
- ▶ Expeller assembly makes ejecting 8" (20.3 cm) plugs a breeze... minimizing frustration and wasted time.
- ▶ Replaceable 8" (20.3 cm) inside sharpened shell also available.

8" (20.3 cm) diameter

28785 Hole Cutter Straight Inside

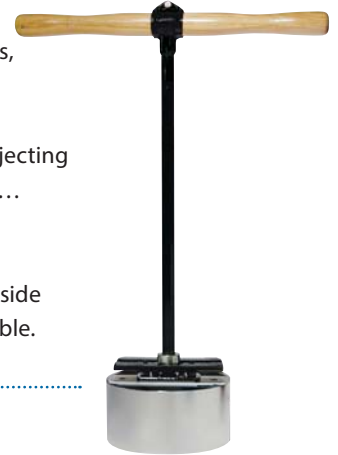

GREENSKEEPER BALL MARK REPAIR TOOL

- ▶ Great time-saving, labor-saving tool for quick, near-flawless repairs on greens.
- ▶ 36" (91 cm) handle makes repairs fast and easy.
- ▶ Meticulously lifts dirt/grass into place in one motion.

27200 Greenskeeper



2" (5 CM) TURF PLUGGER

- ▶ Ideal for replacing small areas of damaged turf. Fill the tube handle with new plugs from any nursery area, then use them to replace damaged plugs when you cut them.
- ▶ Zinc-plated construction.
- ▶ Adjustable blade handles plugs up to 4" (10 cm) deep.

29475 Turf Plugger

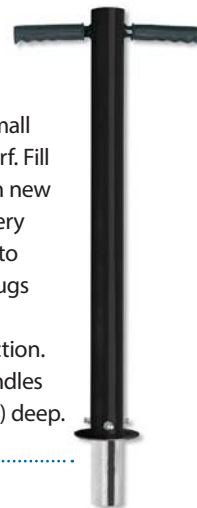

DU-WHIPPER

- ▶ Sweep away morning dew, worm casts and bunker sand instantly.
- ▶ Easy to handle. Even easier to transport.
- ▶ Telescoping fiberglass pole stretches 6' to 16' (2 m to 5 m).
- ▶ Durable threaded cap.

34200 Du-Whipper



Order replacement tips in our parts list, page 94.

COCO FIBER DRAG MAT

- ▶ Two sizes for different needs and budgets.
- ▶ Spreads top dressing with a soft, smooth touch. Perfect for all playing surfaces.
- ▶ Tough, resilient fibers 1 ¼" (3 cm) bond to vinyl-reinforced backing.
- ▶ Smaller lighter-weight mat makes it easy for one operator to use.
- ▶ 10' (3.0 m) chain hooks up to any vehicle.

Weights 65 lbs (29 kg)

53000 4' x 6' (1.2 m x 1.8 m) Drag Mat

Weights 35 lbs (16 kg)

53050 3' x 5' (0.9 m x 1.5 m) Drag Mat



DRAG BRUSH

- ▶ Long-time classic and favorite among superintendents.
- ▶ Gently and evenly works top dressing material into the green and helps control thatch when used before mowing.
- ▶ Extensions available for bigger jobs; hinged and weighted to help manage contours and uneven areas.

26"H x 54 ½"W (66 cm x 138 cm)

52000 Drag Brush Only

52013 Replacement Brush

26"H x 27"W (66 cm x 69 cm)

52050 Set of Two Extensions

52063 Replacement Brush for Extension



CORE PROFILE SAMPLER

- ▶ Triple window tine for fast and simple reads on soil strata.
- ▶ Removable "T" handle pushes cores thru top of tube; fits inside for easy storage.
- ▶ Stainless-steel tine and handle construction.
- ▶ 12" (30 cm) tine.
- ▶ ¾" x 10" (2 cm x 25 cm) samples.
- ▶ Includes convenient storage case.



29450 Core Profile Sampler

WEED WAND

- ▶ For precision chemical applications around flowerbeds, fragile plantings and other tight areas.
- ▶ Lightweight, 36" (92 cm) wand is designed to minimize spills, and for easy refills.
- ▶ 1" (2.5 cm) diameter applicator tips precisely control chemical flow and eliminate overspray.



29700 Weed Wand

Holds 8 oz. (237 ml) of chemical solution.

29701 Replacement Tips

5 per pack



BIODEGRADABLE LANDSCAPE SPIKES

- ▶ Organic spikes – 4" (10 cm) long – hold new sod in place.
- ▶ Dissolves in approximately eight months (depending on soil conditions).
- ▶ 500 per carton.



32300 Biodegradable Landscape Spikes

WIRE LANDSCAPE STAPLES

- ▶ Use to anchor sod and landscape covers, or even to hold hoses in place.
- ▶ Heavy-gauge steel; 6"H x 2"W (15 cm x 5 cm).
- ▶ 504 per carton.

32100 Wire Landscape Staples

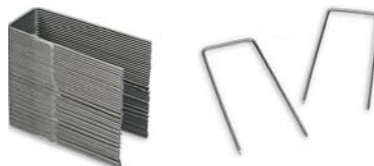

BALL RETRIEVER

- ▶ Powder-coated 5 ¼" (13 cm) diameter aluminum holder attaches to any length pole.

12100 Ball Retriever





RUST-OLEUM SPRAYSMART MARKING PAINT SYSTEM

Golf course markings have never been easier! The SpraySmart system is a patent-pending, propellant free spray system for spraying marking paint. The reusable device operates on compression technology to spray paint using SpraySmart disposable paint pouches. You get the same great coverage, color and durability you would expect from a Rust-Oleum product but with less waste.

- ▶ Propellant free formula sprays on any substrate and in any weather condition; even works on dew covered grass.
- ▶ Designed to fully empty each paint pouch – no waste.
- ▶ Bright and durable colors are safe for grass.
- ▶ Space saving paint pouches can be easily stored or shipped (including overnight air shipping).
- ▶ Device fits in existing marking paint wands.
- ▶ Non-clogging spray tip provides one pass coverage.

57000 SpraySmart Device

55000 Marking Wand

SPRAYSMART PAINT POUCHES

10.5 oz. pouches (311 ml)

Twelve pouches per case

<input type="checkbox"/> White	57001
<input type="checkbox"/> High Visibility Yellow	57002
<input type="checkbox"/> Safety Red	57003
<input type="checkbox"/> Alert Orange	57004
<input type="checkbox"/> Safety Green	57005
<input type="checkbox"/> Caution Blue	57006
<input type="checkbox"/> Fluorescent Pink	57007
<input type="checkbox"/> Fluorescent Orange	57008
<input type="checkbox"/> Fluorescent Green	57009
<input type="checkbox"/> Fluorescent Red/Orange	57010
<input type="checkbox"/> Black	57011
<input type="checkbox"/> Caution Yellow	57012
<input type="checkbox"/> Safety Purple	57013



E-ZEE WHITE HOLE WHITENER SYSTEM

- ▶ Clean, crisp white holes! Made quick and easy!
- ▶ Simply insert paint can into tool and rotate.
- ▶ Improved formula maximizes whiteness on dirt.
- ▶ Built-in shield protects cup and green from overspray.
- ▶ One-piece patented design; no assembly required.
- ▶ No purging required between uses.
- ▶ Starter kit includes tool, plus 1 case of paint. (Six 15-oz. (.42 kg) cans per case.)

- 55500 E-ZEE White Starter Kit
- 55600 E-ZEE White Tool
- 55700 E-ZEE White Paint (Case)

WATCH IT WORK!
www.standardgolf.com



RUST-OLEUM MARKING PAINT

More feet per can. Fewer cans of paint to buy. Every foot of Rust-Oleum Marking Paint you lay down is more money saved. Available in 13 vivid colors for temporary markings on grass, gravel, concrete or asphalt. Twelve 17 oz. (0.48 kg) cans per case.

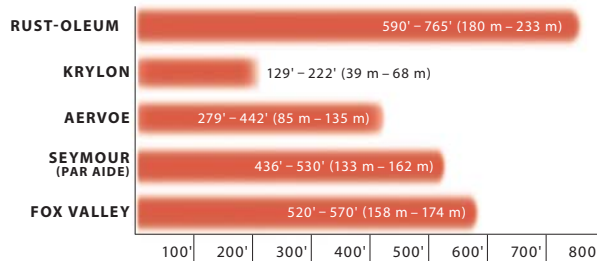

White	55001
High Visibility Yellow	55002
Safety Red	55003
Alert Orange	55004
Safety Green	55005
Caution Blue	55006
Fluorescent Pink	55007
Fluorescent Orange	55008
Fluorescent Green	55009
Fluorescent Red/Orange	55010
Black	55011
Caution Yellow	55012
Safety Purple	55013

MARKING WAND

- ▶ Accurate. Easy to load and shoot. Compatible with any brand of marking paint.
- ▶ Inverted wand – 35" (89 cm) long – is used to mark hazards and ground under repair.
- ▶ Lightweight construction also makes it ideal for greens and pin events.

55000 Marking Wand

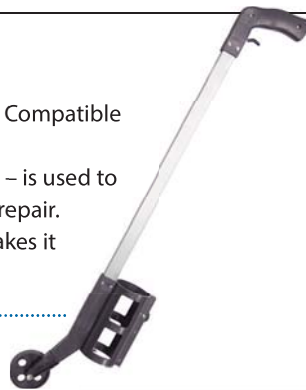

RUST-OLEUM PRECISION LINE INVERTED MARKING CHALK

- ▶ Use white chalk for pin events and green chalk to mask unsightly areas.
- ▶ Applies quickly, washes away with watering.
- ▶ Twelve 17 oz. (0.48 kg) cans per case.

White	55301
Green	55302



STRIPING MACHINES

- ▶ Built to last with solid steel construction. Tilt-away handle for easy storage.
- ▶ Athletic Field model comes with larger wheels (vs Hard Surface units).
- ▶ Both units carry twelve cans of paint.
- ▶ Adjust stripe width between 2" (5 cm) and 4" (10 cm).

- 55100 Athletic Field Striping Machine
- 55200 Hard Surface Striping Machine



RUST-OLEUM STRIPING PAINT

- ▶ Applies quickly.
- ▶ Athletic field striping paint washes away with water.
- ▶ Hard surface striping paint for permanent applications.





	ATHLETIC FIELD STRIPING PAINT 17 oz. cans (0.5 kg) Twelve cans per case	HARD SURFACE STRIPING PAINT 18 oz. cans (0.5 kg) Six cans per case
White	55101	55204
Yellow	55103	55205
Orange	55102	–
Black	–	55201
Blue	–	55202
Red	–	55203

PRACTICE GREEN TARGETS

- ▶ Mark your practice greens without cutting a hole.
- ▶ All-metal targets; perfect for lessons and events, easy to move around.
- ▶ Compatible with Standard Golf small tube practice green flags to match your course decor.

Rod: ¼" (0.6 cm) diameter
23 ½" (60 cm) long. Spike: 5" (13 cm) long

Rod and Knob

	Red	20100
	White	20101
	Blue	20102
	Black	20103



NUMBERED PRACTICE GREEN FLAG SETS

- ▶ Premium Nylon Tube-Lock Flags.
- ▶ Order them in single units (one flag, rod, knob and base) or as a set (nine units).
- ▶ Now made with Dupont SolarMax nylon.



Rod: ⅜" (1.0 cm) diameter
28" (71 cm) long

SET 1-9
with rod, knob and base

SET 10-18
with rod, knob and base

SINGLE UNIT
with rod, knob and base

FLAG ONLY

	Red Flag/White Rod	20691	20690	20692*	20612*
	White Flag/Red Rod	20791	20790	20792*	20712*
	Yellow Flag/Black Rod	20891	20890	20892*	20812*

* Specify hole numbers when ordering single flags.

NUMBERED PRACTICE GREEN PENNANT SETS

- ▶ Classic, one-piece plastic head and fiberglass rod combinations.
- ▶ Order them in single units (one plastic head, rod and base) or as a set (nine units).



Rod: ⅜" (1.0 cm) diameter
28" (71 cm) long

SET 1-9
with rod and base

SET 10-18
with rod and base

SINGLE UNIT
with rod and base

HEAD & ROD
ONLY

	White Head/Red Rod	20391	20390	20392*	20393*
	White Head/Green Rod	20491	20490	20492*	20493*
	Black Head/Yellow Rod	20591	20590	20592*	20593*

* Specify hole numbers by adding "-" and hole number at end of product number. Ex. 20392-2.
To order without numbers, add "-P" to the end of product number. Ex. 20392-P.



CAST ALUMINUM PRACTICE GREEN MARKERS

- ▶ The resiliency and functionality of cast aluminum.
- ▶ Plain or personalized with sets of numbered decals or your club logo.
- ▶ Fits 3/8" (1.0 cm) rods only.

HEAD ONLY	
White	20532
Yellow	20533
Red	20534
Green	20535
Blue	20536
Black	20537



NUMBERED AND PERSONALIZED DECALS

- ▶ Add numbered or personalized decals with your club's logo to your cast aluminum heads and tee markers.
- ▶ Numbered decals ship in two sets of nine (choose 1-9 or 10-18).

NUMBERED DECALS

3" (7.6 cm) diameter	1-9	10-18
White	20541	20540
Yellow	20551	20550
Red	20561	20560
Blue	20571	20570
Black	20581	20580

PERSONALIZED DECALS

Order of 36	20511
Order of 54	20512
Order of 72	20513
Order of 108	20514
Order of 144	20515
Order of 216	20516

Call today if you are interested in customizing any of these products with your logo.

ART CHARGE

21300



KNOBBS FOR PRACTICE GREEN FLAGSTICKS

Fits 3/8" (1.0 cm) diameter rods only

20822



Fits 1/2" (1.3 cm) diameter rods only

20522



ALUMINUM PRACTICE GREEN CUP

- ▶ Bonderite coated aluminum; the most chip-resistant coating around.
- ▶ Beveled bottom edge design makes cup easier to insert and remove.

4" (10 cm) high 4 1/4" (10.8 cm) diameter

18150 Aluminum Practice Green Cup



Shown with beveled edge at bottom.

PLASTIC PRACTICE GREEN CUP

- ▶ Features molded plastic construction and reinforced webs.

4" (10 cm) high 4 1/4" (10.8 cm) diameter

18100 Plastic Practice Green Cup



SOLID METAL BASE

20322



PRACTICE GREEN

PRACTICE GREEN RODS

- ▶ Solid, resilient fiberglass construction.
- ▶ 3/8" (1.0 cm) diameter; 28" (71 cm) long.
- ▶ Knob and base sold separately.

KNOB FOR PRACTICE GREEN ROD

20822



SOLID METAL BASE

20322



SOLID ROD ONLY

	Red	20182
	Black	20282
	White	20382
	Yellow	20482
	Blue	20582
	Green	20682

STRIPED ROD ONLY

	Black/White	20010
	White/Red	20020
	Yellow/Black	20030
	Green/White	20040

Custom Colored Striping
Contact your distributor for pricing.



Fits small tube practice green flags



Fits large tube practice green flags

JUNIOR TOURNAMENT RODS

- ▶ Distinct new look for your practice greens.
- ▶ Solid, resilient fiberglass construction.
- ▶ 1/2" (1.3 cm) diameter tip and ferrule leads to a 3/4" (1.9 cm) diameter center; 32" (81 cm) long.
- ▶ Fits 1/2" (1.3 cm) practice green flags only.
- ▶ Knob and base sold separately.

SOLID ROD ONLY

	White	20200
	Yellow	20225

STRIPED ROD ONLY

	Black/White	20201
	Red/White	20202
	Green/White	20203
	Black/Yellow	20226

Custom Colored Striping **Contact your distributor for pricing.**

KNOB FOR JUNIOR TOURNAMENT ROD

20522



SOLID METAL BASE

20322



PLAIN PRACTICE GREEN FLAGS

- ▶ Now available in 1/2" (1.3 cm) size to fit Junior Tournament practice green rods and Par-Aide practice green rods.
- ▶ Customize them with your logo. (See below.)
- ▶ Made with DuPont SolarMax nylon.



	SMALL TUBE Fits 3/8" (1.0 cm) Rod	LARGE TUBE Fits 1/2" (1.3 cm) Rod
Green	20595	20597
Red	20695	20697
White	20795	20797
Yellow	20895	20897
Blue	20995	20997

Per Set of Nine

CHECKERED PRACTICE GREEN FLAGS

- ▶ For a classier, more distinctive look.
- ▶ Now available in 1/2" (1.3 cm) size to fit Junior Tournament practice green rods and Par-Aide practice green rods.
- ▶ Made with DuPont SolarMax nylon.



	SMALL TUBE Fits 3/8" (1.0 cm) Rod	LARGE TUBE Fits 1/2" (1.3 cm) Rod
Black/White	20910	20915
Red/White	20920	20925
Black/Yellow	20930	20935
Green/White	20940	20945

Per Set of Nine

CUSTOMIZED PRACTICE GREEN FLAGS

- ▶ Revolutionary, state-of-the-art dye sublimation process.
- ▶ Full-color printing capabilities create photo-quality logo reproduction.
- ▶ Maximum UV-resistant material helps maintain long-lasting color.
- ▶ More versatile and economical when compared to traditional screen printed or embroidery processes.
- ▶ Available in 3/8" (1.0 cm) and 1/2" (1.3 cm) sizes to fit Standard Golf and Par-Aide practice green rods.



NEW!
NOW AVAILABLE!
FULL COVERAGE GRAPHICS!

To order add an F to the end of the dye sub part numbers. An additional fee will be added. Contact your distributor for more information.

	SMALL TUBE SET OF NINE Fits 3/8" (1.0 cm) Rod	SMALL TUBE SINGLE Fits 3/8" (1.0 cm) Rod	LARGE TUBE SET OF NINE Fits 1/2" (1.3 cm) Rod	LARGE TUBE SINGLE Fits 1/2" (1.3 cm) Rod
Customized 250 Denier White Practice Green	25900	25902	25950	25952

Minimum order of nine.
Each flag design can be individually customized, available in white only.

PRACTICE GREEN FLAGS SCREEN PRINTING CHARGES

- ▶ From one color to seven colors. Available on plain flags only.
- ▶ Charge does not include base flag cost.



21300 One-time Art Charge

	Set of Nine
One-Color	20901
Two-Color	20902
Three-Color	20903
Four-Color	20904
Five-Color	20905
Six-Color	20906
Seven-Color	20907

EMBROIDERED PLAIN PRACTICE GREEN FLAGS

- ▶ The elegance of embroidery with UV-resistant, color-fast threads for lasting brightness.
- ▶ Includes set of nine plain practice green flags.



Set of Nine

Set-up Charge	20990
Up to 8,000 Stitches	20950
Over 8,000 Stitches	Call for quote

SEWN U.S. PRACTICE GREEN FLAG

- ▶ A nice touch on commemorative holidays.



Fits 3/8" (1.0 cm) rods only.

20985 Set of Nine



MAGNUM HARVESTER BALL PICKER

World's best ball picker ... period!

Superior Dual-Integrated Gang Technology means each gang member PIVOTS INDEPENDENTLY IN ANY DIRECTION for unequalled maneuverability on rolling terrain, in all types of grasses and conditions, when navigating slopes, even when backing away from trees and other obstacles.

- ▶ IT'S THE ONLY GANG PICKER IN THE WORLD THAT BACKS UP WITHOUT GETTING TANGLED OR DAMAGED.
- ▶ No need to exit the vehicle to untangle gangs.
- ▶ LOW-PROFILE – reaches under trees, sweeps close to yardage markers.
- ▶ Powder-coated finish ensures a superior, longer-lasting appearance and better rust resistance.
- ▶ Assembles in less than 15 minutes.
- ▶ U.S. and foreign patents pending.

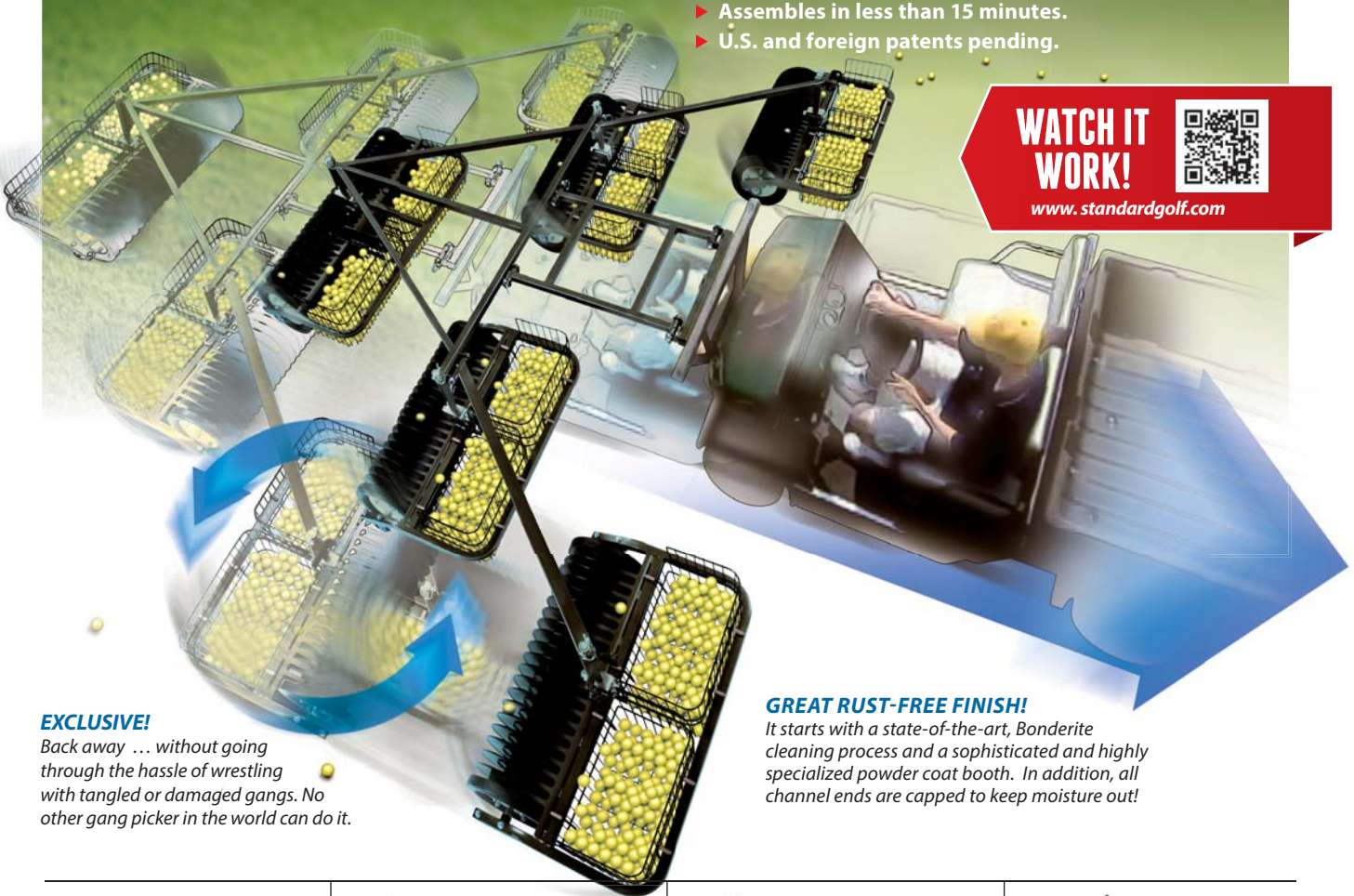

WATCH IT WORK!



www.standardgolf.com

EXCLUSIVE!

Back away ... without going through the hassle of wrestling with tangled or damaged gangs. No other gang picker in the world can do it.

GREAT RUST-FREE FINISH!

It starts with a state-of-the-art, Bonderite cleaning process and a sophisticated and highly specialized powder coat booth. In addition, all channel ends are capped to keep moisture out!



3-GANG UNIT

Covers 9 ft (2.7 m)

Actual Weight: 277 lb (126 kg)
Shipping Weight: 401 lb (182 kg)

85000 3-Gang Unit



5-GANG UNIT

Covers 15 ft (4.6 m)

Actual Weight: 427 lb (194 kg)
Shipping Weight: 631 lb (287 kg)

85100 5-Gang Unit



EXTENSION KIT

Converts a 3-Gang Unit to a 5-Gang Unit.

Actual Weight: 150 lb (68 kg)
Shipping Weight: 230 lb (105 kg)

80300 Extension Kit



REPLACEMENT BASKET

300-Ball Capacity

83119 Replacement Basket

MAGNUM BALL DISPENSERS

As tough as they come ... and as smart and efficient as they get.

The Magnum Ball Dispenser has revolutionized range management, re-engineering it with intelligent electronics contained in a robust, rust-resistant, low-profile housing.

- ▶ Holds up to 12,000 range balls and 2,800 disposable bags.
- ▶ Loads baskets or bags (70 balls max) with exact ball count every time ... GUARANTEED.
- ▶ Photo Eye sensor warns when ball count is low or empty.
- ▶ Anti-jamming sensor works through ball jams.
- ▶ Powder-coated tubular metal framing.
- ▶ Stainless steel components to resist rust.
- ▶ Hydraulic-assist arms upfront for easy maintenance.

49"H x 70"W x 42"D (125 cm x 178 cm x 107 cm)

88000 Magnum Dispenser - 115 Volt

88050 Magnum Dispenser - 230 Volt



MAGNUM TOKENS AND PLASTIC BAGS

Made specifically for Magnum Ball Dispensers.



88410 100 Tokens

88600 700 Plastic Bags

MAGNUM SCRUB-PRO GOLF BALL WASHER

- ▶ Cleans up to 12,000 balls an hour.
- ▶ Exclusive "dimple brush" design cleans even hard-caked dimples.
- ▶ Ships within 48 hours — and virtually ready-to-run right from the crate.

42"H x 35" W x 30"D (107 cm x 89 cm x 76 cm)

Basket Capacity: 375 golf balls Tank Capacity: 8 gallons (30.3 liters)

86000 Magnum Scrub-Pro (115 Volt)

86950 Scrub-Pro Vibrator Motor (115 Volt)

87000 Magnum Scrub-Pro (230 Volt)

87950 Scrub-Pro Vibrator Motor (230 Volt)



Polyethylene body and a tubular steel, powder-coated frame for maximum durability and rust-resistance.



WATCH IT WORK!

www.standardgolf.com

MAGNUM JR. HARVESTER BALL PICKER

For putting and chipping areas and hard-to-reach places. Perfect complement to the popular Harvester Ball Picker.

- ▶ Easy to handle. Ultra-strong 1¼" (3 cm) square tubular steel frame.
- ▶ 300-ball capacity basket.

Actual Weight: 40 lb (18 kg); Shipping Weight: 45 lb (20 kg)

85200 Magnum Jr. Harvester Ball Picker





44 ½" (113 cm) head – 33 ½" (85 cm) height
85300 Range Ball Pusher

RANGE BALL PUSHER

- ▶ Make short work of your practice area cleanup.
- ▶ Proven design features durable PVC frame and exclusive rollers which glide easily across all turf surfaces.
- ▶ 44 ½" (113 cm) wide head makes short work of collecting range balls.

RANGE MARKING POLE

- ▶ Give your range a unique look with these highly visible striped Range Marking Poles.
- ▶ Features high-strength 82" (208 cm) long, 3 ½" (8.9 cm) diameter PVC pipe. UV-resistant paint for superior durability and easy target acquisition.
- ▶ 12" (31 cm) ground anchor holds it firmly in place. Ground anchor sold separately.



82" (208 cm) long 3 ½" (8.9 cm) diameter

Black/White	09750	–
Blue/White	09760	–
Green/White	09770	–
Red/White	09780	–
Special Color Stripe	–	09798



12" (31 cm) high

09790 Ground Anchor

RANGE MATE CLUB WASHER

- ▶ Gentle, no-splash brushes will handle woods and irons.
- ▶ Efficient, effective design with replaceable brushes.
- ▶ Large-capacity, fade-resistant 9-gallon (34 L) polyethylene containers, reinforced with steel frame.

Gray Granite	01600
Hunter Green	01650



01602 Replacement Brush

Use with SparkKleen Ball Cleaner Solution. (See page 10.)

RECYCLED SQUARE CLUB WASHER

- ▶ Our finest Green Line club washer. Smart-looking, slatted-style cubical, 100% recycled material.
- ▶ Compact. 9-gallon (34 L) capacity. Perfect for range and par 3s.

22"H x 18"W x 18"D (56 cm x 46 cm x 46 cm)

Green	200020GN
Brown	200020BR
Black	200020BK

01602 Replacement Brush



RECYCLED CLUB WASHER

- ▶ Premier Green Line club washer.
- ▶ Rugged construction includes 5-gallon (19 L) bucket and hand brush.

32"H x 17"W (81 cm x 43 cm)

Green	200010GN
Brown	200010BR
Black	200010BK



NYLON RANGE BANNERS

- ▶ Crisp, bold-faced, brightly colored, easy-to-read distance banners.
- ▶ Sewn and fitted for PVC frame, which you can build yourself or order from us. (See Range Banner Frame Kit below.)

Horizontal:
24"H x 48"W (61 cm x 122 cm)
Vertical:
48"H x 24" W (122 cm x 61 cm)



	YELLOW / BLACK		GREEN / WHITE	
	Horizontal	Vertical	Horizontal	Vertical
50 yards	31050H	31050V	35050H	35050V
75 yards	31075H	31075V	35075H	35075V
100 yards	31100H	31100V	35100H	35100V
125 yards	31125H	31125V	35125H	35125V
150 yards	31150H	31150V	35150H	35150V
175 yards	31175H	31175V	35175H	35175V
200 yards	31200H	31200V	35200H	35200V
225 yards	31225H	31225V	35225H	35225V
250 yards	31250H	31250V	35250H	35250V
275 yards	31275H	31275V	35275H	35275V
300 yards	31300H	31300V	35300H	35300V



RANGE BANNER FRAME KIT (HEAVY-DUTY)

For both horizontal or vertical banners.

- ▶ Frame, tees and elbows – 1 1/2" (3.8 cm) diameter.
- ▶ Ground anchors – 10" (25 cm) long.
- ▶ Order one kit per banner.

Frame, tees and elbows – 1 1/2" (3.8 cm) diameter
Ground anchors – 10" (25 cm) long

31000 Range Banner Frame Kit



RANGE FLAGS

- ▶ Five nylon flags for 50/100/150/200/250 yardages.
- ▶ Flags measure 18" x 25" (46 cm x 64 cm) and include Snap-Lock swivel snaps.



	NUMBERED FLAGS (set of five distances)	PLAIN FLAGS (no numbers)
18"H x 25"W (46 cm x 64 cm)		
Red	22116	22010
White	22115	22020
Yellow	–	22030
Orange	–	22040
Medium Blue	–	22050
Green	–	22060
Black	–	22070

VERTICAL RANGE FLAGS

- ▶ Make your range standout with these oversized vertical flags.
- ▶ Integrated tube design fits all regulation flagsticks, making installation a snap.
- ▶ Top nut can be adjusted so flag moves with the wind or stays in a fixed position.
- ▶ Includes flag, mounting rod, and hex flange locknut with nylon insert.



VERTICAL RANGE FLAGS 40"H x 14"W (102 cm x 36 cm)

Yellow/Black-50	60050	–
Yellow/Black-100	60100	–
Yellow/Black-150	60150	–
Yellow/Black-200	60200	–
Yellow/Black-250	60250	–
Red	–	60510
White	–	60520
Yellow	–	60530
Orange	–	60540
Medium Blue	–	60550
Green	–	60560
Black	–	60570

RANGE DIVIDER

- ▶ Simple solution to designate hitting areas on your range.
- ▶ Deluxe model's built-in handle makes set up a breeze.
- ▶ Steel spikes (included) for turf ranges.

	RANGE DIVIDER 48"L x 4"H x 2"D (122 cm x 10 cm x 5 cm)	DELUXE RANGE DIVIDER 48"L x 6 1/2"H x 2"D (122 cm x 17 cm x 5 cm)
--	---	--

Green	100170GN	100175GN
Brown	100170BR	100175BR
Black	100170BK	100175BK
White	100170WH	—



SHORT GAME TARGET SYSTEM

- ▶ Economical solution for lessons or special events.
- ▶ Easily adjustable hoop targets expand from 4 to 7 feet (1.2 m x 2.1 m) in diameter.
- ▶ Heavy-duty polyethylene distance markers come in increments of 10.

50000 Short Game Target System
(10 thru 40)

51000 Short Game Target System
(50 thru 80)

50300 Animal Character Decals
(Set of 4 color decals)

EASYMARK SYSTEMS

- ▶ Put a flagstick anywhere, without cutting a cup hole.
- ▶ EasyMark for 0.5" (1.3 cm) non-ferruled flagsticks.
- ▶ EasyMark II for ferruled flagsticks.
- ▶ Versatile tap-in anchor makes it easy to set up flags for special events or on the range.

EasyMark: 6" (15 cm) long 3" (7.6 cm) diameter
Rod: 5' (1.5 m) high 1/2" (1.3 cm) diameter

26760 EasyMark II

26755 EasyMark

26750 EasyMark with Rod



FLAGSTICK STAND

- ▶ Perfect for displaying flagsticks indoors.
- ▶ Powder-coated steel for increased durability.
- ▶ Stand can be mounted for temporary or permanent use.

2 1/4"H x 7 1/2" Diameter (6 cm x 19.1 cm)

26800 Flagstick Stand



RANGE ALIGNMENT ROPE

Set up the range in seconds.

- ▶ Handy spool ... with 100' (30.5 m) of rope.
- ▶ 10 equidistant markers help you evenly space range dividers and place bag stands.



Each spool carries 100' (30.5 m) of rope. Markers—spaced every 10' (3 m)—show you just where to place range dividers.

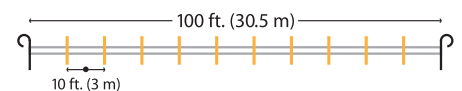

36700 Range Alignment Rope

CLOCK-ON-POST

- ▶ Perfect for ranges or practice greens.
- ▶ Comes with sturdy stand alone support post which can be secured with spikes.
- ▶ Clock-On-Post features a 12" (30.5 cm) clock.
- ▶ Deluxe models feature 18" (45.7 cm) diameter atomic clock with built-in temperature and hydrometer gauges.
- ▶ Includes four ground spikes.

Deluxe
Clock-
On-Post



	CLOCK-ON-POST 36"H x 4"W x 4"D (91 cm x 10 cm x 10 cm)	DELUXE CLOCK-ON-POST 48"H x 4"W x 4"D (122 cm x 10 cm x 10 cm)
Green	100115GN	100110GN
Brown	100115BR	100110BR
Black	100115BK	100110BK

EASEL CLOCKS (SINGLE-SIDED)

- ▶ A striking addition to #1 and #10 tee boxes and clubhouse.
- ▶ Easel clock features 12" (30.5 cm) clock.
- ▶ Deluxe model features 18" (45.7 cm) diameter atomic clock with built-in temperature and hydrometer gauges.

	EASEL CLOCK 23"H x 16"W (58 cm x 41 cm)	DELUXE EASEL CLOCK 22"H x 28"W (56 cm x 71 cm)
Green	100100GN	100120GN
Brown	100100BR	100120BR
Black	100100BK	100120BK

**ADD
YOUR LOGO**
SEE PAGE 7



Deluxe Model

SIX-YARDAGE EASELS (SINGLE-SIDED)

- ▶ Post up to six easy-to-read range flag distances with coordinated and customized flag colors.
- ▶ Larger model comes with 12" (30.5 cm) diameter clock.
- ▶ Includes six sets of numbers (0-8) for posting sign yardages.

	SIX-YARDAGE EASEL 32"H x 22"W (81 cm x 56 cm)	SIX-YARDAGE CLOCK EASEL 40"H x 32"W (102 cm x 81 cm)
Green	100130GN	100140GN
Brown	100130BR	100140BR
Black	100130BK	100140BK



REPLACEMENT CLOCKS

- ▶ Weather-resistant.
- ▶ Two models:
 - 12" diameter (30.5 cm) Easel Replacement Clock.
 - 18" diameter (45.7 cm) Deluxe Easel Atomic Clock features built-in temperature and hydrometer gauges.



200900 12" (30.5 cm) Clock - White

200902 18" (45.7 cm) Atomic Clock - Silver

RANGE EQUIPMENT & ACCESSORIES

BAG CADDIE

- ▶ Economical, streamlined and practical. Holds any size bag.
- ▶ Sharpened spikes for easy "step-in" anchoring.
- ▶ Priced individually. Sold in multiples of two.



44" (112 cm) high

36800 Bag Caddy – Black

BAG STAND

- ▶ Sturdy, wide-stance design for excellent stability.
- ▶ Durable powder-coated finishing.
- ▶ Stackable to conserve space when stored.
- ▶ Priced individually. Sold in multiples of two.



26"H x 14"W x 25"D (66 cm x 36 cm x 64 cm)

36825 Bag Stand – Green

RECYCLED BAG STAND WITH CUP HOLDER

- ▶ This fold-up bag stand is a sharp addition to any area ... with extra room for a drink holder.
- ▶ Resilient, environmentally responsible construction.

28"H x 19"W
(71 cm x 48 cm)

Green	100800GN
Brown	100800BR
Black	100800BK



RECYCLED BAG STAND

- ▶ A favorite on ranges everywhere.
- ▶ Rugged. Reinforced.
- ▶ Folds up for easy storage.

28"H x 19"W
(71 cm x 48 cm)

Green	100700GN
Brown	100700BR
Black	100700BK



RECYCLED BAG RACK

- ▶ Clean, rugged, durable design.
- ▶ Five large bag slots.



31 1/2"H x 72"W
(80 cm x 183 cm)

Green	100900GN
Brown	100900BR
Black	100900BK

DELUXE RECYCLED BAG RACK

- ▶ Upgrade with this ultra-durable recycled bag rack.
- ▶ Order multiple units and place side-by-side or back-to-back for added capacity.



31 1/2"H x 72"W
(80 cm x 183 cm)

Green	100910GN
Brown	100910BR
Black	100910BK

GREEN LINE PREMIUM ROPE STAKES

- ▶ Premium recycled plastic stakes with beveled tops.
- ▶ Zinc coated hardened steel spikes.
- ▶ Rope stakes include convenient speed slot for easy rope installation.
- ▶ Priced individually. Sold in multiples of twelve.

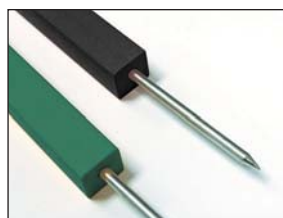

	12" (30 CM) SQUARE with spike	18" (46 CM) SQUARE with spike	24" (61 CM) SQUARE with spike
5½" (14 cm) spike			
■ Green	42012	42018	42024
■ Black	42112	42118	42124



RECYCLED PLASTIC ROPE STAKES

These easy-to-place stakes don't crack, rot or absorb moisture.

- ▶ Accommodates ¼" (0.64 cm) braided rope.
- ▶ Priced individually. Sold in multiples of twelve.

5½" (14 cm) spike Round: 1½" (3.8 cm) diameter	12" (30 CM) with spike		18" (46 CM) with spike		24" (61 CM) with spike	
	Round	Square	Round	Square	Round	Square
■ Green	38160	37850	38360	38050	38260	37950
■ Black	38175	37875	38375	38075	38275	37975

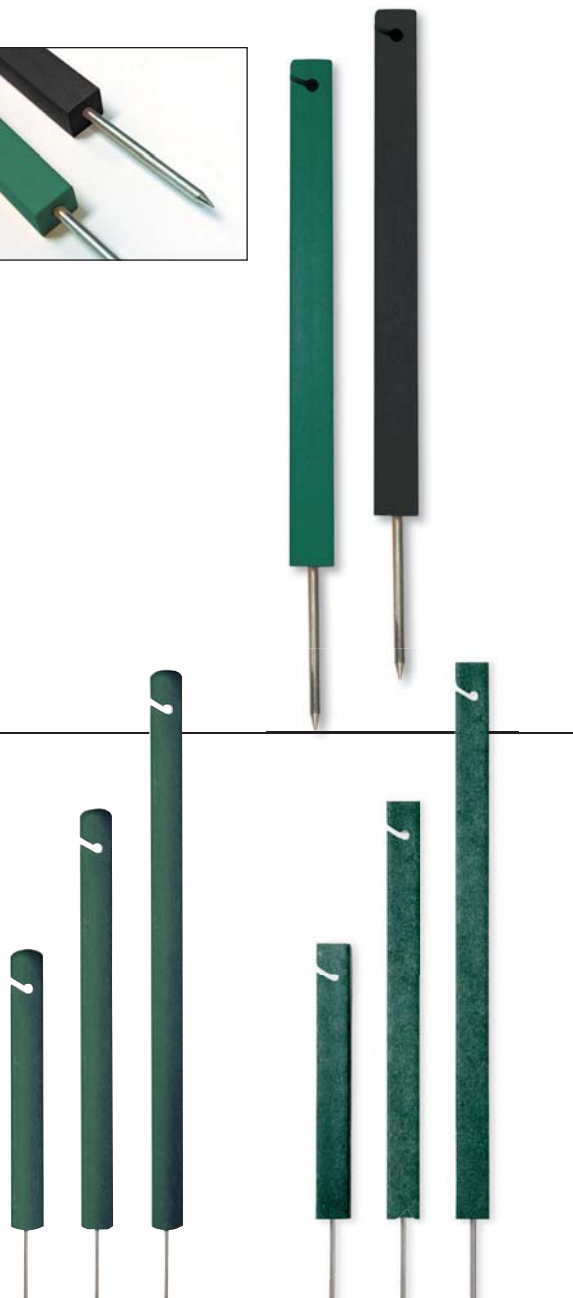

ECO-STEP ROPE AND CHAIN STAKES

Step them into ground and hook either rope or chain to the multi-functional clasp top.

- ▶ 8" (20 cm) long, ⅜" (0.95 cm) diameter galvanized steel spike.
- ▶ Reinforced with long-lasting recycled polymers.
- ▶ Priced individually. Sold in multiples of twelve.

	15" (38 CM) with spike	32" (81 CM) with spike
■ Yellow	37600	37700
■ Green	37650	37750

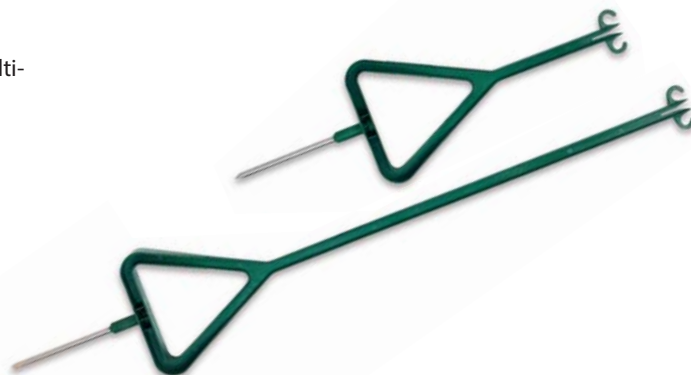

ROPE & CHAIN STAKES

STEEL TURF STAKES

- ▶ Powder-coated steel stake secures plastic chain or ropes.
- ▶ 3/8" (0.95 cm) rods – select 12" (30 cm) or 25" (64 cm) heights.
- ▶ 1/2" (1.3 cm) rods are 36" (91 cm) high.
- ▶ Priced individually. Sold in multiples of twelve.

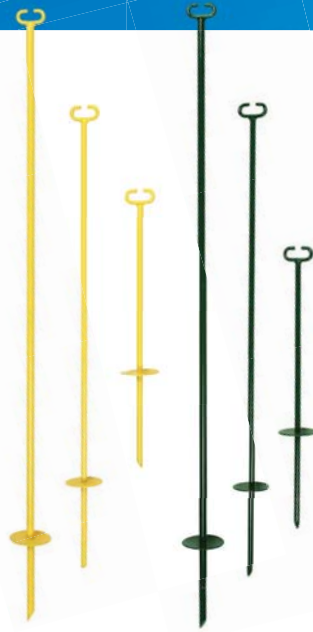

	12" (30 CM)	25" (64 CM)	36" (91 CM)
Yellow	38200	38300	38400
Green	38250	38350	38450

STEEL ROPE STAKES

- ▶ Popular, value-priced solution.
- ▶ Positions easily with foot pressure.
- ▶ 6" (15 cm) long, 5/16" (0.79 cm) diameter spike.
- ▶ Priced individually. Sold in multiples of twelve.

	14" (36 CM)	32" (81 CM)
Yellow	37400	37500
Green	37450	37550

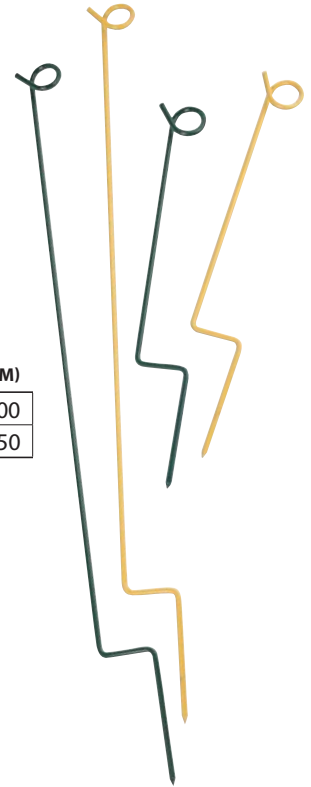

BRAIDED ROPE

- ▶ 1/4" (0.64 cm) diameter polypropylene braided rope.
- ▶ 1000' (304 m) per spool.

Yellow	37100
Green/White	37150
Green	37200
Black	37250

Splicing Fid for 1/4" (0.64 cm) Rope	37299
--------------------------------------	-------



TURF GUARD FENCE

Guide cart traffic around worn areas with Turf Guard Fence.

- ▶ Simple 3/8" (0.95 cm) diameter frame; bright yellow powder coating.
- ▶ Also suitable for hanging direction signs or warnings.
- ▶ Priced individually. Sold in multiples of four.

18"H x 48"W (46 cm x 122 cm)
38000 Turf Guard Fence





WRAPAROUND SAFETY GLASSES

- ▶ One-piece wraparound lens allows maximum safety and unobstructed vision.
- ▶ Flexible temples and non-slip rubber head grips.

75000 Clear

75050 Tinted



SOFT FOAM EARPLUGS

- ▶ Made of self-adjusting foam with a tapered shape for increased comfort.
- ▶ Each pair of earplugs comes in a poly bag, keeping them clean before use.

Sold in boxes of 200

75100 Soft Foam Earplugs



DISPOSABLE GENERAL-PURPOSE NITRILE GLOVES

- ▶ Superior tear strength and dexterity.
- ▶ Chemical-resistant.

Sold in boxes of 100

75300 Large

75350 X-Large



NITRILE GLOVES

- ▶ Pebble grip finish for maximum usability and comfort.
- ▶ Chemical-resistant, perfect for all treatment needs.

Sold in boxes of 12

75500 Green-Large

75550 Green-X-Large



PARTICLE RESPIRATOR MASK

- ▶ Offers protection when the job requires work around tiny particles.
- ▶ Adjustable nose clip ensures a more secure seal against the face.

Sold in boxes of 20

75200 Particle Mask



3M REUSABLE HALF FACE RESPIRATOR

- ▶ Reusable half faced respirators offer comfort, convenience and cost savings.
- ▶ Respirator cartridges sold separately.

75250 Medium

75275 Large



3M RESPIRATOR CARTRIDGES

- ▶ Organic vapor/acid gas cartridge is NIOSH approved against certain organic vapors and gases.
- ▶ Swept-back design for enhanced field of view and balance.

Pack of 2 cartridges

75255 Replacement Cartridges



DISPOSABLE SPRAY SUITS

- ▶ Economical grey coveralls feature zipper front, open wrists and ankles.
- ▶ Three-layer fabric has cloth like polypropylene outside and web microfibers in the middle.

Boxes of 25

75400 Grey-Large

75450 Grey-X-Large

BOLD. CRISP. CLEAR.
GREEN

AND RIGHT TO THE POINT!

GREEN LINE FAIRWAY SIGNS

- ▶ Single- or double-sided signage with 5" (13 cm) galvanized screw-in stakes.
- ▶ Choice of two sizes: 9"H x 15"W (23 cm x 38 cm) or 6"H x 12"W (15 cm x 30 cm).
- ▶ Tough, long-lasting laminated material.
- ▶ Outstanding fade-resistance.
- ▶ For a little extra you can design your own sign. Call today for details.



GREEN/WHITE Single-Sided	6"H x 12"W (15 cm x 30 cm)	9"H x 15"W (23 cm x 38 cm)
	Carts On Path Only	09501
Drop Area	09502	09902
Ground Under Repair	09503	09903
Keep Carts 30' From Green	09504	09904
No Carts	09505	09905
Please Repair Ball Marks	09506	09906
Replace Divots	09507	09907

SINGLE-SIDED	6"H x 12"W (15 cm x 30 cm)	9"H x 15"W (23 cm x 38 cm)
	Customized Sign	09598

GREEN/WHITE Double-Sided	6"H x 12"W (15 cm x 30 cm)	9"H x 15"W (23 cm x 38 cm)
	Carts On Path Only	09551
Drop Area	09552	09952
Ground Under Repair	09553	09953
Keep Carts 30' From Green	09554	09954
No Carts	09555	09955
Please Repair Ball Marks	09556	09956
Replace Divots	09557	09957

DOUBLE-SIDED	6"H x 12"W (15 cm x 30 cm)	9"H x 15"W (23 cm x 38 cm)
	Customized Sign	09599

21300SS One-time Art Charge for Customized Signs

GREEN LINE ARROW SIGNS

- ▶ Double-sided, 13" (33 cm) long directional signs.
- ▶ For a little extra you can design your own sign. Contact your local distributor for more information.

21300SS One-time Art Charge for Customized Signs

10299 Customized Plastic Sign



MADE TO ORDER

Don't see exactly what you want in this catalog? No problem. Call today and ask about customizing your sign order.

13" (33 cm) long

Carts	10200
Next Tee	10202
Golf Cars	10204
No. 1 Tee	10206-1
No. 2 Tee	10206-2
No. 3 Tee	10206-3
No. 4 Tee	10206-4

13" (33 cm) long

No. 5 Tee	10206-5
No. 6 Tee	10206-6
No. 7 Tee	10206-7
No. 8 Tee	10206-8
No. 9 Tee	10206-9
No. 10 Tee	10206-10
No. 11 Tee	10206-11

13" (33 cm) long

No. 12 Tee	10206-12
No. 13 Tee	10206-13
No. 14 Tee	10206-14
No. 15 Tee	10206-15
No. 16 Tee	10206-16
No. 17 Tee	10206-17
No. 18 Tee	10206-18

GREEN LINE PLASTIC SIGNS

- ▶ Wide selection of horizontal 5"H x 10"W (13 cm x 25 cm) signage.
- ▶ For a little extra you can design your own sign. Contact your local distributor for more information.

5"H x 10"W (13 cm x 25 cm)

21300SS One-time Art Charge for Customized Signs



Single-Sided

Carts on Path Only	08715
No Golf Carts Beyond Here	08717
Please Repair Ball Marks	08719
Carts (with double arrow)	08722
Scatter (with arrows)	08723
90° Rule	08725
Driving Range Closed	08727
Keep Carts 30 Feet from Green	08728
Ground Under Repair	08729
No Chipping	08731

Double-Sided

Ground Under Repair	08716
Please Keep Off	08718
Green Closed	08720
Carts (with one way arrow)	08721
Drop Area	08724
Next Tee (with one way arrow)	08726
No Chipping	08730

CUSTOMIZED PLASTIC SIGN

	Single-Sided	Double-Sided
Sign	08798	08797

GREEN LINE INFORMATION SIGNS

- ▶ 12" x 12" (30 cm x 30 cm) sign.
- ▶ Ready to mount. Outstanding durability.
- ▶ For a little extra you can design your own sign. Contact your local distributor for more information.

12"H x 12"W (30 cm x 30 cm)

In-Stock Information Signs (see right)

10398-1 Customized One-Color Image

10398-2 Customized Two-Color Image



10398-3 Customized Three-Color Image

21300SS One-time Art Charge for Customized Signs



FAIRWAY SIGNS



- ▶ 4½"H x 9"W (11 cm x 23 cm) signs.
- ▶ Includes two 5½" (14 cm) stakes.



4½"H x 9"W (11 cm x 23 cm)			
	GREEN/WHITE	GREEN/TAN	GREEN
Carts On Path Only	09151	09171	-
Drop Area	09152	09172	-
Ground Under Repair	09153	09173	-
Keep Carts 30' From Green	09154	09174	-
No Carts	09155	09175	-
Please Repair Ball Marks	09156	09176	-
Replace Divots	09157	09177	-
Plain/No Decals	-	-	09158



DIRECTION ARROWS

- ▶ Includes two 9½" (24 cm) galvanized screw-in stakes.

						
	WHITE/YELLOW 11" (28 cm) 15" (38 cm)	GREEN/WHITE 11" (28 cm) 15" (38 cm)	GREEN/TAN 11" (28 cm) 15" (38 cm)	GREEN/TAN 11" (28 cm) 15" (38 cm)	GREEN/TAN 11" (28 cm) 15" (38 cm)	GREEN/TAN 11" (28 cm) 15" (38 cm)
Carts	10100	10000	10150	10050	10170	10070
Next Tee	10102	10002	10152	10052	10172	10072
Golf Cars	10104	10004	10154	10054	10174	10074
No. ___ Tee	-	-	-	10056	-	10076
Buggies	-	-	10160	10060	-	-
Trolleys	-	-	10162	10062	-	-

				
	WHITE 11"H x 2¾"W (28 cm x 6 cm)	WHITE 15"H x 4"W (38 cm x 10 cm)	GREEN 11"H x 2¾"W (28 cm x 6 cm)	GREEN 15"H x 4"W (38 cm x 10 cm)
Plain/No Decals	10108	10008	10158	10058



**DON'T SEE
EXACTLY
WHAT YOU WANT?
CUSTOMIZE IT!**



If you don't see the sign you need on these pages, we'll customize one of our Aluminum or Green Line Plastic Signs for you. Just pick the size and style you would like and tell us what you want it to say.

ALUMINUM INFORMATION SIGNS - 12" X 12" (30 CM X 30 CM)

- ▶ Single-sided. Silk-screened with weather-resistant ink.
- ▶ Order Sign Posts separately. (See page 66.)
- ▶ Provide artwork for signs not printed in English.

12"H x 12"W (30 cm x 30 cm)

In-Stock Aluminum Information Signs (see below)

- 10321 Chemically Treated Area Sign with Erasable Pen
- 10330 Erasable Aluminum Sign
- 10399 Customized Aluminum Sign
- 21300SS One-Time Art Charge for Customized Signs

					
10300	10301	10302*	10305	10306	10307
					
10308	10310	10312	10315	10323	10334
					
10335	10338	10330	10324IL Illinois	10324KY Kentucky	10324WI Wisconsin
			<p>*Part number 10302 is available with any hole number. A reversible arrow decal is included.</p>		
10311	10317	10321			

PLASTIC ENGRAVED SIGNS - 12" X 12" (30 CM X 30 CM)

- ▶ Pre-drilled holes are matched with our Sign Posts for easy mounting. (See page 66.)
- ▶ Consult your state regulatory commission to determine which sign you need.

12"H x 12"W (30 cm x 30 cm)

- 10324OH Plastic Engraved Signs – OH
- 10324IA Plastic Engraved Signs – IA
- 10329 Custom Engraved Plastic Sign

Plastic Engraved Signs

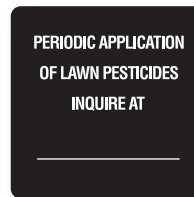

10324OH
Ohio



10324IA
Iowa

SIGNS

ALUMINUM INFORMATION SIGNS - 6" X 12" (15 CM X 30 CM)

- ▶ Single-sided informational signs serve as helpful reminders to players and mount easily on single spike mounting base.
- ▶ Includes mounting base.

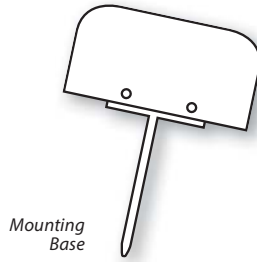

6"H x 12"W (15 cm x 30 cm)

In-Stock Aluminum Information Signs

08599 Customized Aluminum Sign

21300SS One-time Art Charge for Customized Signs



08501



08510



08502



08511



08506



08504



08513

ONE-PIECE ALUMINUM SIGNS - 5" X 12" (13 CM X 30 CM)

- ▶ Single-sided, one-piece rust-free aluminum. Economical. Easy to use.
- ▶ Green, silk-screened lettering on a white background.

5"H x 12"W (13 cm x 30 cm)

08799 Customized One-Piece Aluminum Sign

21300SS One-Time Art Charge for Customized Signs

90 Degree Rule	08701
Carts on Paths Only	08702
Caution Alternative Spikes May Slip	08703
Ground Under Repair	08705
Keep Golf Carts 30 Feet From Green	08706
No Golf Carts Beyond Here	08708
Please Keep Off	08709
Please Repair Ball Marks	08711
Practice Tee Closed	08712
Putting Green Closed	08713



CLOCK-ON-POST

- ▶ Perfect for ranges or practice greens.
- ▶ Comes with sturdy stand alone support post which can be secured with spikes.
- ▶ Clock-On-Post features a 12" (30.5 cm) clock.
- ▶ Deluxe models feature 18" (45.7 cm) diameter atomic clock with built-in temperature and hydrometer gauges.
- ▶ Includes four ground spikes.



Deluxe Clock-On-Post

	CLOCK-ON-POST 36"H x 4"W x 4"D (91 cm x 10 cm x 10 cm)	DELUXE CLOCK-ON-POST 48"H x 4"W x 4"D (122 cm x 10 cm x 10 cm)
--	--	---

Green	100115GN	100110GN
Brown	100115BR	100110BR
Black	100115BK	100110BK

REPLACEMENT CLOCKS

- ▶ Weather-resistant.
- ▶ Two models:
 - 12" diameter (30.5 cm) Easel Replacement Clock.
 - 18" diameter (45.7 cm) Deluxe Easel Atomic Clock features built-in temperature and hydrometer gauges.



200900	12" (30.5 cm) Clock – White
200902	18" (45.7 cm) Atomic Clock – Silver

SIX-YARDAGE EASELS (SINGLE-SIDED)

- ▶ Post up to six easy-to-read range flag distances with coordinated and customized flag colors.
- ▶ Larger model features 12" (30.5 cm) diameter clock.
- ▶ Includes six sets of numbers (0-8) for posting sign yardages.

	SIX-YARDAGE EASEL 32"H x 22"W (81 cm x 56 cm)	SIX-YARDAGE CLOCK EASEL 40"H x 32"W (102 cm x 81 cm)
--	--	---

Green	100130GN	100140GN
Brown	100130BR	100140BR
Black	100130BK	100140BK

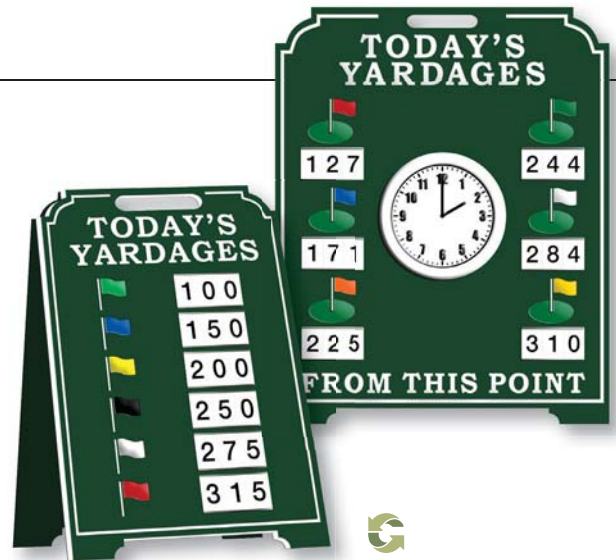

EASEL CLOCKS (SINGLE-SIDED)

- ▶ A striking addition to #1 and #10 tee boxes and clubhouse.
- ▶ Easel clock features a 12" (30.5 cm) clock.
- ▶ Deluxe model features 18" (45.7 cm) diameter atomic clock with built-in temperature and hydrometer gauges.

	EASEL CLOCK 23"H x 16"W (58 cm x 41 cm)	DELUXE EASEL CLOCK 22"H x 28"W (56 cm x 71 cm)
--	--	---

Green	100100GN	100120GN
Brown	100100BR	100120BR
Black	100100BK	100120BK



Deluxe Model

TURFSTONE PERSONALIZED SIGNS

- ▶ The look of granite. Durable.
- ▶ Crack- and fade-resistant.
- ▶ Hardware for horizontal and vertical mounting is included with sign.

	6" X 8" (15 CM X 20 CM)	9" X 12" (23 CM X 30 CM)
Gray Granite	07099	07199
One Color		
Two Colors		
Three Colors		



Honor a staff member or benefactor of your club when you add a photo-quality, laser engraved image to our 9" x 12" (23 cm x 30 cm) TurfStone signs.

Add a photo-quality image to your TurfStone sign.

10698 Photo Image Charge

Optimize your TurfStone sign with a classic black frame.

67190 TurfStone Sign Frame



PERMANENT & TEMPORARY SIGN POSTS

- ▶ Permanent posts can be removed and stored in the off-season.
- ▶ Temporary models can quickly be removed or repositioned.
- ▶ All hardware included.



	58" (147 CM)	36" (91 CM)	24" (61 CM)	GROUND ANCHOR	40" (102 CM)	18" (46 CM)	TURFSTONE VERTICAL	TURFSTONE HORIZONTAL
	Holds four 9" x 12" or 12" x 12" signs	Holds one 9" x 12" or 12" x 12" sign	Holds one 6" x 8", 9" x 12" or 12" x 12" sign		Holds one 9" x 12" or 12" x 12" sign	Holds one 9" x 12" or 12" x 12" sign	Holds one 6" x 8" or 9" x 12" sign	Holds one 9" x 12" sign

Permanent	10458	10436	10424	36205	—	—	—	—
Temporary	—	—	—	—	10400	10418	—	—
TurfStone Stakes	—	—	—	—	—	—	10600	10625

TurfStone personalized signs mounted on a 58" (147 cm) permanent post.

DELUXE SCRUSHER & SCRUSHER

- ▶ Three separate bottom brushes now with softer, longer-lasting nylon bristles.
- ▶ Two side brushes with gentler bristles that don't scratch the sides of shoes.
- ▶ The wider design of the Deluxe Scrusher offers more stability and extra space between lower bristles to prevent buildup.
- ▶ Durable cast aluminum, powder-coated base included on the Deluxe model.
- ▶ Mounting stakes sold separately, four per unit (See below.)

6 1/2" H x 22 1/4" W x 6" D (16.5 cm x 56.5 cm x 15.2 cm)

14000 Deluxe Scrusher

14100 Scrusher

14102 Bottom Replacement Brush

14103 Side Replacement Brush

MOUNTING STAKES

6" (15 cm) long

14106 Asphalt Mounting Stake

18" (46 cm) long

14124 Turf Mounting Stake



Scrusher



Deluxe Scrusher

DELUXE SCRUSHER HANDLE

- ▶ Helps players maintain more stability and balance.
- ▶ Bolts securely to the underside of the Deluxe Scrusher. (Hardware included.)

31 1/2" H x 10 1/2" W (80 cm x 27 cm)

14050 Deluxe Scrusher Handle

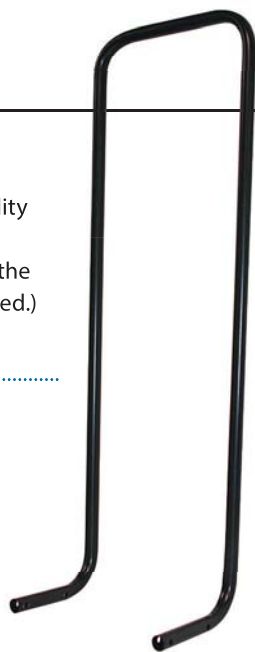

SPIKE KLEENER

- ▶ Efficient synthetic bristles. Durable, cast aluminum, powder-coated base.
- ▶ Includes four 3 1/2" (8.9 cm) stakes.



5 3/8" x 5 1/8" (14 cm x 13 cm)

Red	14350
Green	14450
Black	14750

5 3/8" x 5 1/8" (14 cm x 13 cm)

14252 Replacement Brush

SPIKE CLEANERS

DELUXE COMPRESSED AIR SHOE CLEANERS

- ▶ Blows dirt and grass off shoes with compressed air.
- ▶ Traps clippings in an easy-to-remove tray.
- ▶ Deluxe model includes air wand.
- ▶ Air-compressor housing sold separately.
- ▶ Air compressor is not included.

DELUXE COMPRESSED AIR SHOE CLEANER

38"H X 26"W X 22"D (97 cm x 66 cm x 56 cm)

Green	100190GN
Brown	100190BR
Black	100190BK

AIR COMPRESSOR HOUSING

24"H X 14"W X 22"D (61 cm x 36 cm x 56 cm)

Green	100199GN
Brown	100199BR
Black	100199BK



Air compressor housing



Housing can be placed next to the shoe cleaner unit.



**ADD
YOUR LOGO**
SEE PAGE 7

DUO-KLEENER STAND

- ▶ Put this useful spike cleaner to work wherever it's needed most.
- ▶ Anchors in asphalt or in the ground with turf stakes.
- ▶ Includes stand, brushes, hardware and three 3½" (9 cm) spikes.

36650 Duo-Kleener Stand

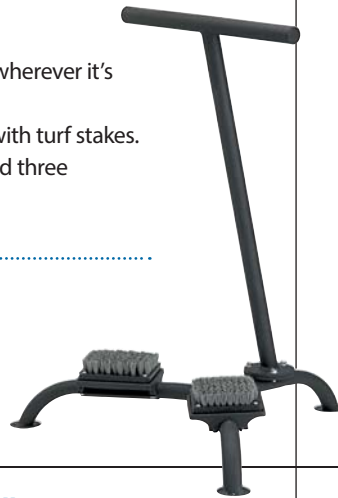

BOOT CLEANER

- ▶ Sturdy, rugged design.
- ▶ Simultaneously brushes sides and bottoms of boots.
- ▶ Also comes with integrated mud scraper.

14111 Boot Cleaner



VERTICAL POST MOUNT WITH BRUSH

14950 Vertical Post Mount with Brush



CONSOLE MOUNT WITH BRUSH

36156B Console Mount with Brush



GREEN LINE

TEE SIGNS AND POSTS



GREEN LINE TEE SIGNS

- ▶ Stylish. Low maintenance. Weather-resistant tee signs.
- ▶ All signs include club logo, hole number, par, yardage with optional hole layout.
- ▶ Sign comes pre-drilled for easy installation. Please specify if you do not want the signs drilled when ordering.
- ▶ Green Line Mounting Post sold separately.
- ▶ Includes six color-matched mounting screws.

CUSTOMIZED GREEN LINE CURVED SIGNS WITH LAYOUT
23 1/2"H x 17 1/2"W x 1/2"D
(60 cm x 44 cm x 1 cm)

CUSTOMIZED GREEN LINE CURVED SIGNS WITHOUT LAYOUT
23 1/2"H x 17 1/2"W x 1/2"D
(60 cm x 44 cm x 1 cm)

CUSTOMIZED GREEN LINE DELUXE SIGNS WITH LAYOUT
23 1/2"H x 17 1/2"W x 1/2"D
(60 cm x 44 cm x 1 cm)

CUSTOMIZED GREEN LINE DELUXE SIGNS WITHOUT LAYOUT
23 1/2"H x 17 1/2"W x 1/2"D
(60 cm x 44 cm x 1 cm)

Green/White	300700	300705	300600	300605
Black/White	300750	300755	300650	300655

GREEN LINE POSTS

- ▶ The perfect mounting option for our Green Line Tee Signs.
- ▶ Features decorative beveled top.

72" (183 cm) long, 4"W x 4"D (10 cm x 10 cm)

Green	300800GN
Black	300800BK

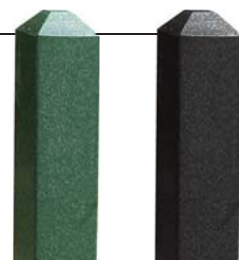

6 DIFFERENT TEE CONSOLE PACKAGES.

- ▶ Everything is included.
- ▶ All selections come with bold, contrasting black stands/posts.
- ▶ Each combination includes matching Ball Washer/Trash Receptacle.
- ▶ Granite-like TurfStone signage on selected packages.

TRADITION TEE CONSOLE KIT 1

- ▶ Classic. Robust. Versatile.
- ▶ 19" (48 cm) cast aluminum base makes it easy to reposition to reduce wear and tear.
- ▶ Includes spikes to anchor it firmly into the ground.
- ▶ Includes Tradition Console Stand (Black) and your choice of a Premier or Medalist Ball Washer.



WITH PREMIER BALL WASHER WITH MEDALIST BALL WASHER

Red	39125	39225
Green	39150	39250
Black	39170	39270

TRADITION TEE CONSOLE KIT 2

- ▶ Classic. Robust. Versatile.
- ▶ 19" (48 cm) cast aluminum base makes it easy to reposition to reduce wear and tear.
- ▶ Includes spikes to anchor it firmly into the ground.
- ▶ Includes Tradition Console Stand (Black), your choice of a Premier or Medalist Ball Washer, plus matching single Litter Mate unit.



WITH PREMIER BALL WASHER WITH MEDALIST BALL WASHER

Red	39325	39425
Green	39350	39450
Black	39370	39470

TRADITION TEE CONSOLE KIT 3

- ▶ Classic. Robust. Versatile.
- ▶ 19" (48 cm) cast aluminum base makes it easy to reposition to reduce wear and tear.
- ▶ Includes spikes to anchor it firmly into the ground.
- ▶ Includes Tradition Console Stand (Black), your choice of a Premier or Medalist Ball Washer, plus matching double Litter Mate unit.



WITH PREMIER BALL WASHER WITH MEDALIST BALL WASHER

Red	39525	39625
Green	39550	39650
Black	39570	39670

JUNIOR TEE CONSOLE KIT

- ▶ Wide-stance tripod-style stand combines simplicity, utility, affordability; and it's built to last.
- ▶ Very portable. Easy to move around to minimize wear and tear in high-traffic areas.
- ▶ Screw-in spikes (included) anchor it firmly into the ground.
- ▶ Includes Junior Console Stand (Black) with a Classic Ball Washer and color-matched 9-gallon (34 L) Litter Caddy with spike.



WITH CLASSIC BALL WASHER

Red	39825
Green	39850
Black	39870

GREEN LINE JUNIOR TEE CONSOLE KIT



- ▶ Style and durability that is easy on the budget.
- ▶ Includes customized, color-matched Green Line signage - 9" x 11¾" (23 cm x 30 cm) - with hole number, par and up to four distances.
- ▶ Includes Junior Console Stand (Black) with Classic Ball Washer and color-matched 9-gallon (34 L) Litter Caddy with spike.



FREE SPONSORSHIP ENGRAVING
ON EACH CLASSIC BALL WASHER WITH COMPLETE ORDER

WITH CLASSIC BALL WASHER

Green	39950
Black	39970

TURFSTONE TEE CONSOLE KIT

- ▶ Displays hole layout on rich granite-style TurfStone. (Up to ten colors.)
- ▶ Includes classy, laser-engraved TurfStone Tee Sign - 16" x 24" (41 cm x 61 cm).
- ▶ Includes 36" (91 cm) TurfStone Console Stand (Black), Classic Ball Washer with color-matched 9-gallon (34 L) Litter Caddy with spike and ground anchor.



WITH CLASSIC BALL WASHER

Red	67825
Green	67850
Black	67870

BUILD TO SUIT

It's easy to customize the perfect tee console for your course. Simply follow steps 1 thru 4. Pick your stand. Then, configure it with the exact options you want for your tee boxes. **Need help? Call today for details.**

1 PICK A STAND

PERMANENT MOUNTING POST

36248 48" (122 cm)
Post



JUNIOR TEE CONSOLE

36200 Junior
Console Stand



33" (84 cm)
tripod base
and post
assembly

TRADITION TEE CONSOLE

36230 Traditional
Console Stand

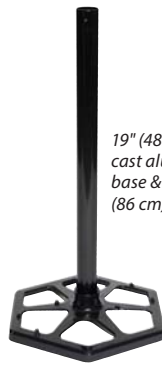

19" (48 cm)
cast aluminum
base & 34"
(86 cm) post

TURFSTONE JUNIOR TEE CONSOLE

67500 TurfStone Junior
Console Stand



41" (104 cm)
tripod
base and
post
assembly

TURFSTONE TEE CONSOLE

65204 TurfStone
Console Stand



37" (94 cm)
post, ball
washer
bracket,
Litter
Caddie
bracket
and ground
anchor

2 ADD A BALL WASHER

PREMIER BALL WASHER

Single Ball / Plunger-style

Red	01425
Green	01450
Black	01470



MEDALIST BALL WASHER

Single Ball / Plunger-style

Red	01525
Green	01550
Black	01570



CLASSIC BALL WASHER

Four Ball / Crank-style

Red	01325
Green	01350
Black	01370
Yellow	01300
Brown	01340
Blue	01375
White	01395



3 ADD TRASH RECEPTACLES

LITTER MATE

- Includes hardware and trash opening lids.
- 9-gallon (34 L) capacity per unit.

	SINGLE	DOUBLE
Red	12825	12925
Green	12850	12950
Black	12870	12970



Not available
on TurfStone™ Tee
Console

9-GALLON (34 L) LITTER CADDIE - WITH SPIKE

White	13100
Red	13150
Blue	13175
Yellow	13400
Green	13700
Black	13195



4 ADD SPIKE BRUSHES

TRADITION TEE CONSOLE

14252 Replacement Brush

JUNIOR TEE AND TURFSTONE JUNIOR TEE CONSOLES

36156B Console Mount with Brush

A NEW LOOK AT TEE SIGNAGE

TurfStone Tee Signs give your course the look of granite at a fraction of the cost. They're also more durable than wood or synthetics because they're made with molded composite materials that resist cracking, fading, staining and chemicals.

EASY ORDERING

- ▶ Provide us with a scorecard or an architectural drawing of your layout and we'll take care of the rest.
- ▶ Allow three weeks for delivery after approval of color proofs.
- ▶ Easily mounts horizontally or vertically on 16" (41 cm), 26" (66 cm) or 36" (91 cm) posts.



Gray Granite



Horizontal

You can personalize your TurfStone with your hole layouts. Our precision laser system captures every detail and uses UV-resistant inks for a look that lasts for years. Available on both horizontal and vertical signs.

TURFSTONE TEE SIGNS

16" x 24" (41 cm x 61 cm)	ONE-COLOR SIGN post and anchor not included	TWO- OR THREE-COLOR SIGN post and anchor not included	FOUR- TO TEN-COLOR SIGN post and anchor not included
Gray Granite	65230	65220	65200

TURFSTONE JUNIOR TEE DATA SIGNS



TEE DATA SIGN 9" x 12" (23 cm x 30 cm)	without logo	Plus 1-color logo	Plus 2-color logo	Plus 3-color logo
Gray Granite	67200	67201	67202	67203

SIGN FRAME ONLY

Black	67190
-------	-------

TURFSTONE SIGNAGE



OPTIONAL
DONOR SIGN
6" X 8"
(15 cm x 20 cm)

OPTIONAL
DONOR SIGN
9" x 12"
(23 cm x 30 cm)

Gray Granite	07099	07199
--------------	-------	-------

One Color
Two Colors
Three Colors

Hardware for horizontal and vertical mounting is included with sign.

TURFSTONE TEE SIGN POSTS

Order ground anchors separately.

65216	16" (41 cm) Post with Hardware
65226	26" (66 cm) Post with Hardware
65236	36" (91 cm) Post with Hardware



GROUND ANCHOR

65205	18" (46 cm) Ground Anchor with Hardware
-------	--



THE MARK OF A

CHAMPION COURSE

CENTENNIAL SERIES TEE MARKERS

Engraved tee markers are designed to impress.

- ▶ Available in bronze or aluminum.
- ▶ Double-sided and richly accented.
- ▶ Choose from a variety of color backgrounds.
- ▶ Design your own custom markers. Call today for more information.

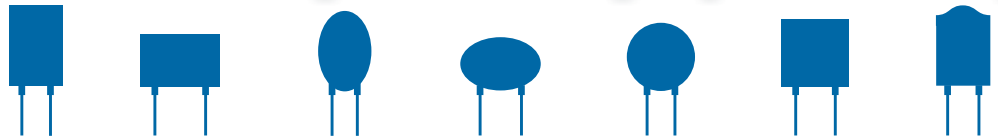

ALUMINUM

with two 4" (10 cm) stainless steel spikes

	VERTICAL RECTANGLE 4" x 6" (10.2 cm x 15.2 cm)	RECTANGLE 6" x 4" (15.2 cm x 10.2 cm)	VERTICAL OVAL 4" x 6" (10.2 cm x 15.2 cm)	OVAL 6" x 4" (15.2 cm x 10.2 cm)	ROUND 5" (12.7 cm) diameter	SQUARE 5" x 5" (12.7 cm x 12.7 cm)	CREST 4" x 6" (10.2 cm x 15.2 cm)
Red	300130AL	300136AL	300142AL	300148AL	300154AL	300160AL	300166AL
White	300131AL	300137AL	300143AL	300149AL	300155AL	300161AL	300167AL
Blue	300132AL	300138AL	300144AL	300150AL	300156AL	300162AL	300168AL
Gold	300133AL	300139AL	300145AL	300151AL	300157AL	300163AL	300169AL
Black	300134AL	300140AL	300146AL	300152AL	300158AL	300164AL	300170AL
Green	300135AL	300141AL	300147AL	300153AL	300159AL	300165AL	300171AL

BRONZE

with two 4" (10 cm) stainless steel spikes

	VERTICAL RECTANGLE 4" x 6" (10.2 cm x 15.2 cm)	RECTANGLE 6" x 4" (15.2 cm x 10.2 cm)	VERTICAL OVAL 4" x 6" (10.2 cm x 15.2 cm)	OVAL 6" x 4" (15.2 cm x 10.2 cm)	ROUND 5" (12.7 cm) diameter	SQUARE 5" x 5" (12.7 cm x 12.7 cm)	CREST 4" x 6" (10.2 cm x 15.2 cm)
Red	300130BZ	300136BZ	300142BZ	300148BZ	300154BZ	300160BZ	300166BZ
White	300131BZ	300137BZ	300143BZ	300149BZ	300155BZ	300161BZ	300167BZ
Blue	300132BZ	300138BZ	300144BZ	300150BZ	300156BZ	300162BZ	300168BZ
Gold	300133BZ	300139BZ	300145BZ	300151BZ	300157BZ	300163BZ	300169BZ
Black	300134BZ	300140BZ	300146BZ	300152BZ	300158BZ	300164BZ	300170BZ
Green	300135BZ	300141BZ	300147BZ	300153BZ	300159BZ	300165BZ	300171BZ

TRIAD TEE MARKER

- ▶ Sleek low-profile design. Ultra-durable.
- ▶ 100% recycled material.

TRIAD
2 1/2"H x 3 1/2"W (6 cm x 9 cm)

Red	100030
White	100031
Blue	100032
Yellow	100033
Black	100035
Green	100039

4" (10 cm) spike



TILTED BLOCK TEE MARKER

- ▶ Simple square cube makes an attractive angular marker design.
- ▶ 100% recycled material.

TILTED BLOCK
3 1/2"H x 3 1/2"W (9 cm x 9 cm)

Red	100010
White	100011
Blue	100012
Yellow	100013
Black	100015
Green	100019

4" (10 cm) spike

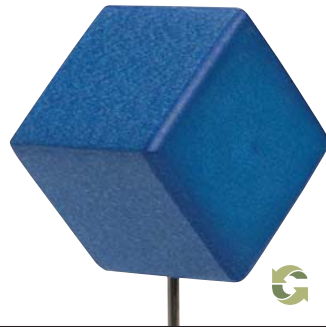

TOWER TEE MARKER

- ▶ Stacked, high-profile beveled tower design enhances any tee area.
- ▶ 100% recycled material.

TOWER
6"H x 4"W (15 cm x 10 cm)

Red	100040
White	100041
Blue	100042
Yellow	100043
Black	100045
Green	100049

4" (10 cm) spike



STRUCTURED TEE MARKER

- ▶ Layered double-block style is built to last.
- ▶ 100% recycled material.

STRUCTURED
4 1/2"H x 4"W x 4"D (11 cm x 10 cm x 10 cm)

Red	100020
White	100021
Blue	100022
Yellow	100023
Black	100025
Green	100029

4" (10 cm) spike



RECYCLED RUBBER TEE DISTANCE MARKER

- ▶ Brilliant UV-resistant colors.
- ▶ 100% recycled material.

RECYCLED RUBBER
8" (20.3 cm) 11" (27.9 cm)
5 1/2" (14 cm) spike 9 1/2" (24 cm) spike

Red	09000	09050
White	09001	09051
Blue	09002	09052
Yellow	09003	09053
Black	09005	09055



STEEL TEE DISTANCE MARKER

- ▶ Sharp, powder-coated 16-gauge steel construction.
- ▶ 1/2" (1.3 cm) lip.

STEEL
6 1/2" (16.5 cm) diameter

Red	09250
White	09251
Blue	09252
Yellow	09253
Black	09255
Green	09259

5 1/2" (14 cm) spike



TEE MARKERS

BRANCH TEE MARKER

- ▶ An old favorite. Natural, rustic look.
- ▶ Durable, heavy-resin material.

BRANCH

3"H x 2 3/4"W x 9 1/2" D (8 cm x 7 cm x 24 cm)

Red	05850
White	05851
Blue	05852
Yellow	05853
Black	05855
Green	05859

2" (5 cm) spikes

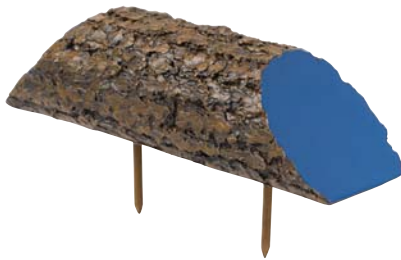

LOG TEE MARKER

- ▶ Compact and popular alternative to Branch Tee design.

LOG

4 1/4"H x 4"W (11 cm x 10 cm)

Red	05650
White	05651
Blue	05652
Yellow	05653
Black	05655

3 1/2" (9 cm) spike



STEEL MARKER

- ▶ Heavy-gauge steel.
- ▶ Powder-coated finish.

STEEL

5" (12.7 cm) diameter

Red	05200
White	05201
Blue	05202
Yellow	05203
Black	05205
Green	05209

5 1/2" (14 cm) spike



METALLIC TEE MARKER

- ▶ Heavy-gauge steel finished with attractive metallic-textured powder-coating.

METALLIC

5" (12.7 cm) diameter

Gold	05000
Silver	05001
Bronze	05002
Black	05003

5 1/2" (14 cm) spike



GLOBE TEE MARKER

- ▶ Classic granite-like feel.
- ▶ Won't crack, peel or absorb water.

GLOBE

Stripe Color 3 1/2" (8.9 cm) diameter

Red	05900
White	05901
Blue	05902
Yellow	05903
Black	05905
Green	05909

3" (8 cm) spike



CROWN ALUMINUM MARKER

- ▶ Ventilated design preserves tee grass.
- ▶ Powder-coated aluminum.

CROWN ALUMINUM

6" (15.2 cm) diameter 2" (5 cm) high

Red	05700
White	05701
Blue	05702
Yellow	05703
Black	05705
Green	05709
Pink	05710



PLAIN DIMPLE-T MARKER

- ▶ The original. Most durable ever built.
- ▶ Favorite of golf courses worldwide.

DIMPLE-T
Plain
5" (12.7 cm) diameter

Red	05250
White	05251
Blue	05252
Yellow	05253
Black	05255
Silver	05256
Gold	05257
Orange	05258
Green	05259

4 ½" (11 cm) spike



PERSONALIZED DIMPLE-T MARKER

- ▶ Personalize the classic Dimple-T Marker with your club logo.
- ▶ Decals priced separately.

DIMPLE-T
Personalized
5" (12.7 cm) diameter Decal: 3" (7.6 cm) diameter

Red	05270
White	05271
Blue	05272
Yellow	05273
Black	05275
Silver	05276
Gold	05277
Orange	05278
Green	05279

4 ½" (11 cm) spike



For decal information call today.

WEDGE MARKER

- ▶ Molded low-profile design.
- ▶ Customize them with multi-colored logo design.
- ▶ Decals priced separately.

WEDGE
5"H x 4"W
(13 cm x 10 cm)

Red	05150
White	05151
Blue	05152
Yellow	05153
Black	05155
Green	05159

3" (8 cm) rear spike



For decal information call today.

CLASSIC-T MARKER

- ▶ One-piece, easy-to-handle design.
- ▶ Economical option, built to last.

CLASSIC-T
3 ½" (8.9 cm) diameter

Red	05600
White	05601
Blue	05602
Yellow	05603
Black	05605
Green	05609

3" (8 cm) spike



CAST ALUMINUM MARKER

- ▶ Powder-coat finish.
- ▶ For a little extra you can customize it with your logo. Contact your local distributor for more information.

CAST ALUMINUM
3 ½" (8.9 cm) diameter

Red	05750
White	05751
Blue	05752
Yellow	05753
Black	05755
Green	05759

5 ½" (14 cm) spike



SAF-T MARKER

- ▶ Aluminum cap and spike.
- ▶ Value-priced and virtually indestructible.

SAF-T PLASTIC
3 ¾" (9.5 cm) diameter

Red	05300
White	05301
Blue	05302
Yellow	05303

3 ½" (9 cm) spike



TEE MARKERS

RECYCLED BROKEN TEE CADDIE

Bigger drivers and longer tees mean more broken tees.

- ▶ Low-maintenance wire mesh bottom lets dirt and sand sift through.
- ▶ 100% recycled material endures for years.

6½"W x 8¼"L (17 cm x 21 cm)

Green	100600GN
Brown	100600BR
Black	100600BK



BROKEN TEE CADDIE

Sleek cone-shape design minimizes footprint.

- ▶ Powder-coated steel construction.
- ▶ Includes "Broken Tee" decal and 5" (13 cm) spike.

6" H (15 cm) 5" (13 cm) spike

Black – White decal	19000
Yellow – Black decal	19015
Red – White decal	19025
Green – White decal	19050
Blue – White decal	19075
Orange – White decal	19085
White – Black decal	19095



TURFSTONE MARKERS

- ▶ High-density plastic marker has the striking look and feel of granite at a fraction of the cost.
- ▶ Includes two 3½" (9 cm) plated steel rear spikes.
- ▶ For a little extra you can customize it with a one-color laser-engraved design in the color of your choice. Contact your local distributor for more information.

2¼"H x 5½"W x 6"D (6 cm x 14 cm x 15 cm)

Gray Granite – Plain	05806
Terra Cotta – Plain	05807

Minimum order of nine markers required.

05860 Additional Tee Marker Engraving Charge



MICROFIBER TEE TOWELS

Seven times the absorbency and three times the wicking power of cotton.

- ▶ Stain-, odor- and UV-resistant.
- ▶ Microfiber stays cleaner longer, dries faster, requires less maintenance.
- ▶ You can embroider them with your club logo.

18"H x 6"W tri-fold (46 cm x 15 cm)
Priced per dozen

<input type="checkbox"/> Black	-	04500
<input type="checkbox"/> Red	04501	-
<input type="checkbox"/> White	04502	-
<input type="checkbox"/> Green	-	04503

Price per dozen. Charge does not include base towel cost.

04290 Embroidery Charge

One-time charge up to 8,000 stitches

20990 Logo Set-Up Charge



LARGE COTTON TOWELS

- ▶ Embroider or screen print with your club logo.

18"H x 6"W tri-fold (46 cm x 15 cm)
Priced per dozen

04100	White
04200	Green

Per dozen plus towel price

04290	Embroidery
04299	Screen Printing – One Color

One-time charge

20990	Logo Set-Up Charge
21300	One-Color Art Charge



WIZ DISPOSABLE TOWELS

- ▶ Absorbent and abundant.
- ▶ 200 per case.

24"H x 6"W duo-fold (61 cm x 15 cm)

<input type="checkbox"/> Blue	04301
<input type="checkbox"/> White	04401



ECONOMY TEE TOWELS

- ▶ Stay well stocked, even on tight-fisted budgets.
- ▶ 200 per case.



21"H x 7"W duo-fold (53 cm x 18 cm)

<input type="checkbox"/> Green/White	04969
--------------------------------------	-------

CHIX WASHABLE TEE TOWELS

- ▶ Absorbent and reusable.
- ▶ 200 per case.



21"H x 7"W duo-fold (53 cm x 18 cm)

<input type="checkbox"/> Green	04970
--------------------------------	-------

CHIX DISPOSABLE TEE TOWELS

- ▶ Reinforced with nylon threads and tough metal eyelet.
- ▶ 200 per case.



21"H x 7"W duo-fold (53 cm x 18 cm)

<input type="checkbox"/> Green/White	04965
--------------------------------------	-------

THE ORIGINAL

TAPERED LITTER CADDIE

Perfectly shaped to properly contain trash contents.

- ▶ 20-gauge steel with rich, durable powder-coat finish.
- ▶ Select 9-gallon (34 L) and 30-gallon (114 L) sizes.

	9-GALLON (34 L)		30-GALLON (114 L)	
	4 3/4" (12 cm) spike	base	12" (30 cm) spike	base
White	13100	13200	13000	13003
Red	13150	13152	13050	13053
Blue	13175	13177	13080	13083
Yellow	13400	13500	13025	13028
Green	13700	13800	13075	13078
Black	13195	13197	13095	13098

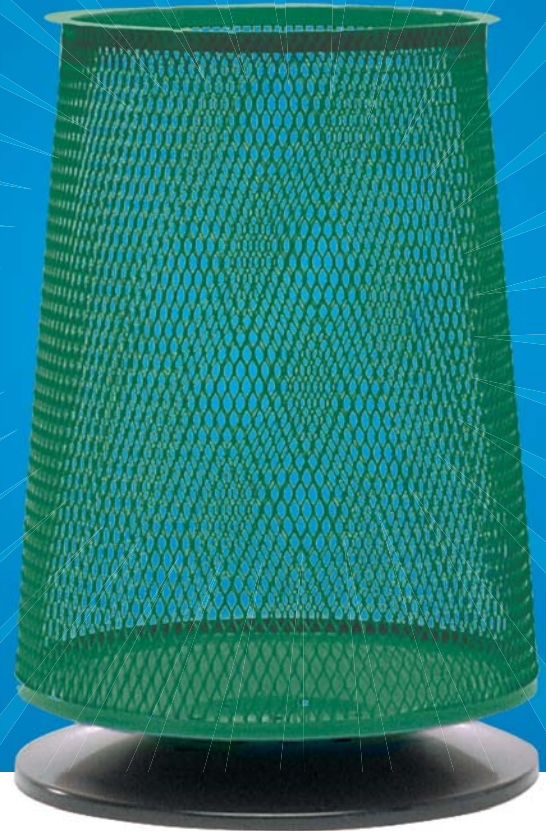

Stainless steel webbing

STAINLESS STEEL LITTER CADDIE

Stainless ... the name says it all.

- ▶ 20-gallon (76 L) capacity, rust-proof caddy.
- ▶ Designed for long life and easy bag removal.
- ▶ Use heavy-duty steel base or spikes for in-ground installations.

20-GALLON (76 L)
12" (30 cm) spike base

Red	13950	13953
Green	13975	13978
Black	13995	13998



VERTICAL MOUNT BRACKET

- ▶ Attaches 9-gallon (34 L) caddies to any 2 3/8" (6.0 cm) O.D. round post.

14901 Vertical Mount Bracket



SANDY SOIL CADDIE SPIKE

- ▶ For sandy/loose soil, a longer 10" (25 cm) spike is available for 9-gallon (34 L) Litter Caddy at no extra charge.
- ▶ Specify part #13105 when ordering.

13105 No Extra Charge

LITTER CADDIE LINER

- ▶ Roll them up and snap them open inside to preserve clean, longer-lasting Litter Caddies.
- ▶ Flexible, black, polypropylene liners are easy to remove for cleaning.



13850	9-gallon (34 L) <i>Priced individually. Sold in multiples of three.</i>
13870	20-gallon (76 L) <i>Priced individually. Sold in multiples of two.</i>
13860	30-gallon (114 L) <i>Priced individually. Sold in multiples of two.</i>

CADDIE COVERS

- ▶ Durable polyethylene container tops.
- ▶ Snaps onto 9-, 20- and 30-gallon (34 L, 76 L and 114 L) Caddies.



13190	Fits 9-gallon (34 L) Caddy
13090	Fits 20- (76 L) and 30-gallon (114 L) Caddy

DECALS



CANS OR BOTTLES



TRASH ONLY

8 3/4" W x 2 1/8" H
(22.2 cm x 6 cm)

4" W x 5/8" H
(10.2 cm x 1.6 cm)

20- & 30-GALLON (76 & 114 L)

9-GALLON (34 L)

fits both Litter Caddy and Litter Mate

Cans or Bottles	13091	13191
Trash Only	13092	13192

LITTER MATE

No dents ... no rust ... three color selections in UV-resistant polyethylene.

- ▶ Accented with tough molded black lid.
- ▶ Mounts to any 2 3/8" (6.0 cm) O.D. post.
- ▶ Includes pole mounting hardware.
- ▶ 9-gallon (34L) capacity per unit.



	SINGLE UNIT 1 liner w/trash opening lid and hardware	DOUBLE UNIT 2 liners w/trash opening lids and hardware
--	---	---

Red	12825	12925
Green	12850	12950
Black	12870	12970

MOUNTING & STANDS

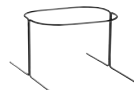

LOW STAND



FLAT SURFACE MOUNT



SINGLE UNIT POLE MOUNT with hardware



DOUBLE UNIT POLE MOUNT with hardware

	LOW STAND	FLAT SURFACE MOUNT	SINGLE UNIT POLE MOUNT with hardware	DOUBLE UNIT POLE MOUNT with hardware
Complete Stand	12985	12986	-	-
Hoop Frame	-	-	12982	12982 x2
Pole Mounting Bracket	-	-	12983	12983 x2
Back Clamp	-	-	12984	-
Pole Mount Hardware	-	-	12988	12987 x1

TRASH CONTAINERS

5-GALLON (19 L) ROUND TRASH CONTAINER

Attractive and compact.

- ▶ 100% recycled plastic design.
- ▶ Includes removable liner and convenient lid.

17½"H x 14"W (44 cm x 36 cm)

Green	200100GN
Brown	200100BR
Black	200100BK



**ADD
YOUR LOGO**
SEE PAGE 7

10-GALLON (38 L) RECYCLED SQUARE TRASH CONTAINER

Unparalleled durability.

- ▶ Heavy-duty construction. Low-profile. 100% recycled material.
- ▶ Includes liner.

18½"H x 19"W x 19"D (47 cm x 48 cm x 48 cm)

Green	200150GN
Brown	200150BR
Black	200150BK



RECYCLED ROUND TRASH CONTAINERS

The bigger the container, the less you have to maintain.

- ▶ Sleek, stylish slatted design fits anywhere.
- ▶ 100% recycled material.
- ▶ Includes liner.

	20-GALLON (76 L)	32-GALLON (121 L)
	24"H x 19"W (61 cm x 48 cm)	33"H x 19"W (84 cm x 48 cm)

Green	200180GN	200190GN
Brown	200180BR	200190BR
Black	200180BK	200190BK



20-GALLON (76 L) RECYCLED SLATTED TRASH CONTAINER

Trash removal and maintenance made easy. Just lift the lid!

- ▶ Made from 100% recycled material.
- ▶ Attractive and built to last.
- ▶ Includes liner.

24"H x 24"W x 24"D (61 cm x 61 cm x 61 cm)

Green	200160GN
Brown	200160BR
Black	200160BK



16-GALLON (61 L) RECYCLED SQUARE TRASH CONTAINER

A classy complement for tees or clubhouse areas.

- ▶ Attractive side paneling.
- ▶ Easy-open hinged lid for quick trash removal.
- ▶ Includes liner.

30"H x 16" W x 16"D (76cm x 40 cm x 40 cm)

Green	200170GN
Brown	200170BR
Black	200170BK



26-GALLON (98 L) RECYCLED TRASH CONTAINER

Big-time capacity!

- ▶ Innovative, side-loading design for easy access.
- ▶ Includes liner.

43"H x 19"W x 19"D (109 cm x 48 cm x 48 cm)

Green	200200GN
Brown	200200BR
Black	200200BK



TRIPOD WATER STATION

Very practical. Very portable.

- ▶ Fold-up design is perfect solution for temporary water needs.
- ▶ Holds a 10-gallon (38 L) Igloo cooler (not included).
- ▶ Cooler Cover Lock (pg. 85) provides added protection.



39"H x 25"W (99 cm x 64 cm)

Green	200340GN
Brown	200340BR
Black	200340BK

DELUXE TRIPOD WATER STATION

Our most popular Green Line station.

- ▶ Slatted container on foldable stand. Lockable and very portable.
- ▶ Holds 10-gallon (38 L) Igloo cooler (not included).



67½"H x 25"W (172 cm x 64 cm)

Green	200350GN
Brown	200350BR
Black	200350BK

ADD YOUR LOGO
SEE PAGE 7

FULL ENCLOSURE WATER STATION

Same basic cooler as open-stand design in full length, fully enclosed housing.

- ▶ Holds 10-gal (38 L) Igloo cooler (not included).
- ▶ Includes cup dispenser and convenient, self-closing trash door. (Liner included.)



70"H x 27"W x 24"D (178 cm x 69 cm x 61 cm)

Green	200300GN
Brown	200300BR
Black	200300BK

OPEN BASE WATER STATION

Classy. Streamlined. Versatile.

- ▶ 4-post open-stand housing for 10-gallon (38 L) Igloo cooler (not included).
- ▶ Includes cup dispenser.



70"H x 23"W x 23"D (178 cm x 58 cm x 58 cm)

Green	200320GN
Brown	200320BR
Black	200320BK

DELUXE DOUBLE WATER STATION

Designed for heavy traffic areas.

- ▶ Houses dual, 10-gallon (38 L) Igloo coolers (not included).
- ▶ Includes centrally-located cup dispenser.
- ▶ Two trash containers. (Liners included.)

71"H x 50"W x 24"D (180 cm x 127 cm x 61 cm)

Green	200310GN
Brown	200310BR
Black	200310BK



WATER STATIONS

KOOLER-AID AND JUNIOR KOOLER-AID WATER STATIONS

Colorful. Rust-resistant. Place them anywhere!

- ▶ 10-gallon (38 L) Igloo and 5-gallon (19 L) Igloo cooler capacity stations.
- ▶ Choose one of our pre-configured kits or build your own.

WATER STATION KITS

Includes stand, tamper-safe top, Igloo water cooler and cup dispenser.

	KOOLER-AID KIT <i>Includes 10-gallon (38 L) cooler</i>	JUNIOR KOOLER-AID KIT <i>Includes 5-gallon (19 L) cooler</i>
Green	45150	48150
Black	45170	48170
Red	45125	48125

BUILD-YOUR-OWN KOOLER-AID WATER STATIONS

1 CHOOSE YOUR TOP

	KOOLER-AID TOP <i>holds 10-gallon (38 L) cooler</i>	JUNIOR KOOLER-AID TOP <i>holds 5-gallon (19 L) cooler</i>
Green	40151	47151
Black	40171	47171
Red	40126	47126

2 CHOOSE YOUR STAND

	KOOLER-AID STAND <i>with mounting tray</i>	JUNIOR KOOLER-AID STAND <i>with mounting tray</i>
Black	40200	47200

GROUND ANCHOR

36205 18" (46 cm) Ground Anchor with Hardware

3 CHOOSE YOUR IGLOO WATER COOLER

	10-GALLON (38 L) <i>Igloo water cooler</i>	5-GALLON (19 L) <i>Igloo water cooler</i>
Green	45400	48400

4 CUP DISPENSER

- ▶ Compatible with 4-oz. (0.12 L) to 4.5-oz. (0.13 L) rolled rim, cone-shaped paper cups. Includes lid.

45600 Cup Dispenser

PAPER CUPS

- ▶ 4.25-oz. (0.13 L) rolled rim cone-shaped cups.
- ▶ 5,000-quantity cases (20 sleeves of 250).

45650 Case of 5,000



RECYCLED ICE CHEST CONTAINER

- ▶ Attractive, durable Green Line container blends in anywhere.
- ▶ Discretely stores 54-quart ice chest (included).

24"H x 31 1/2"W x 19"D (61 cm x 80 cm x 48 cm)

Green	200360GN
Brown	200360BR
Black	200360BK



IGLOO WATER COOLERS

- ▶ ABS construction. Ultratherm insulation.
- ▶ Long-lasting, thirst-quenching performance.
- ▶ Includes mounting bracket for cup holder.

10"D (25.4 cm) 17"H (43 cm)

48400 5-Gallon (19 L)

16 1/2"D (41.9 cm) 23"H (58 cm)

45400 10-Gallon (38 L)



COOLER COVER LOCK

- ▶ Fight contamination head on.
- ▶ Fits 5- or 10-gallon (19 L or 38 L) Igloo Coolers.
- ▶ All locks keyed the same, so you can add more any time.

45700 Cooler Cover Lock
Includes Padlock

45701 Padlock Only

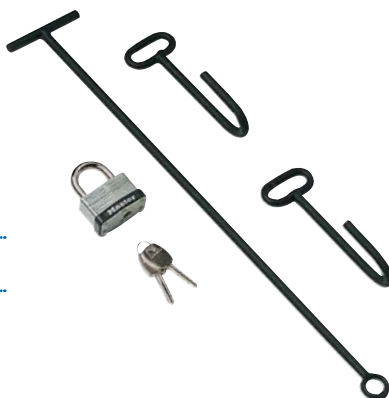

YARDAGE MARKERS

ALL-FLEX HAZARD/YARDAGE MARKERS

- ▶ Ground-breaking design allows markers to be run over in any direction without damage.
- ▶ Super-tough polyurethane joint for maximum flex.
- ▶ Replaceable, UV-resistant polycarbonate sleeve for added protection.
- ▶ Ground anchor sold separately.
- ▶ Not intended for use on fairways.
- ▶ Priced individually. Sold in multiples of twelve.



19" (48 cm) long, plus 7" (18 cm) spike

<input type="checkbox"/> White	15000
<input type="checkbox"/> Yellow	15100
<input type="checkbox"/> Red	15200
<input type="checkbox"/> Blue	15300



ALL-FLEX GROUND ANCHOR

- ▶ Install All-Flex ground anchor flush to the ground.

7 3/8" (19 cm) long

15500 Ground Anchor

PREMIUM GREEN LINE YARDAGE MARKERS

- ▶ Premium recycled plastic stakes feature a decorative beveled top and rich vibrant UV-resistant colors.
- ▶ 5 1/2" (14 cm) zinc coated hardened steel spike makes it easy for players to remove and replace.
- ▶ Priced individually. Sold in multiples of twelve.



5 1/2" (14 cm) spike

	12" (30 CM) SQUARE with spike	18" (46 CM) SQUARE with spike	24" (61 CM) SQUARE with spike
<input type="checkbox"/> White	17012	17018	17024
<input type="checkbox"/> Yellow	17112	17118	17124
<input type="checkbox"/> Red	17212	17218	17224
<input type="checkbox"/> Blue	17312	17318	17324

RECYCLED PLASTIC YARDAGE MARKERS - REMOVABLE

- ▶ Secure in a fixed position with PVC ground anchors.
- ▶ Molded with UV-resistant colors; won't crack, rot or absorb moisture.
- ▶ Priced individually. Sold in multiples of twelve.



Round: 1 1/2" (3.8 cm) diameter

	32" (81 CM) ROUND
<input type="checkbox"/> White	16700
<input type="checkbox"/> Yellow	16725
<input type="checkbox"/> Red	16750
<input type="checkbox"/> Blue	16775

RECYCLED PLASTIC YARDAGE MARKERS - WITH SPIKES

- ▶ Molded with UV-resistant colors; won't crack, rot or absorb moisture.
- ▶ 5" (13 cm) steel spike makes it easy for players to remove and replace.
- ▶ Priced individually. Sold in multiples of twelve.



5" (13 cm) spike

Round: 1 1/2" (3.8 cm) diameter

	24" (61 CM) ROUND with spike
<input type="checkbox"/> White	16600
<input type="checkbox"/> Yellow	16625
<input type="checkbox"/> Red	16650
<input type="checkbox"/> Blue	16675

PVC GROUND ANCHOR AND DRIVING TOOL

Round: 7" (18 cm) long

16157 Round

16158 Driving Tool



Order ground anchors and driving tools separately from markers.

PVC DISTANCE MARKERS

- ▶ For a sharp, more visible look.
- ▶ Easy to install with 7" (18 cm) PVC ground anchor and driving tool, not included. (See above.)
- ▶ Includes cap and decal.

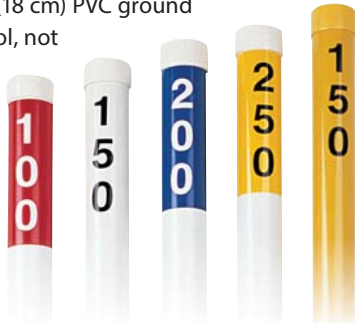

32" (81 cm) long
Round: 1 1/2" (3.8 cm) diameter

	100	150	200	250
White/Red	09310	-	-	-
White/Black	-	09320	-	-
White/Blue	-	-	09330	-
White/Yellow	-	-	-	09340
Yellow/Black	-	09350	-	-

FAIRWAY MARKING POLE

- ▶ 60" (152 cm) long, 1 1/2" (3.8 cm) diameter poles. Heavy-duty PVC pipe.
- ▶ 10" (25 cm) deep, 2" (5.1 cm) diameter ground anchor (included) holds it firmly in place.

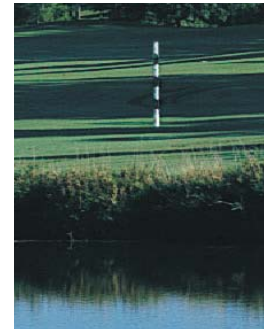

60" (152 cm) long 1 1/2" (3.8 cm) diameter

09700 Fairway Marking Pole

09799 Special Colored Stripe

Ground Anchor

REMOVABLE RECYCLED PLASTIC STRIPED DISTANCE MARKERS

- ▶ Approved by German Golf Federation.
- ▶ 32" (81 cm) long, 1 1/2" (3.8 cm) diameter markers. UV-resistant to prevent cracking, rotting and moisture absorption.
- ▶ Priced individually. Sold in multiples of twelve.

Round: 1 1/2" (3.8 cm) diameter	32" (81 cm) ROUND
One Stripe (100 m)	09360
Two Stripes (150 m)	09370
Three Stripes (200 m)	09380



STEEL FAIRWAY DISTANCE MARKERS

- ▶ Rich, powder-coated 11" (27.9 cm) diameter steel discs.
- ▶ Slightly curved for improved and discreet visibility.
- ▶ Includes 9 1/2" (24 cm) steel spike.



11" (27.9 cm) diameter

Red	09200
White	09201
Blue	09202
Yellow	09203

RECYCLED RUBBER FAIRWAY DISTANCE MARKERS

- ▶ UV-resistant distance markers – 100% recycled – don't rust, chip or damage mower blades.
- ▶ Includes spike.



8" (20.3 cm) 11" (27.9 cm)
5 1/2" (14 cm) spike 9 1/2" (24 cm) spike

Red	09000	09050
White	09001	09051
Blue	09002	09052
Yellow	09003	09053
Black	09005	09055

YARDAGE MARKERS

CENTENNIAL SERIES YARDAGE MARKERS

Add class, sophistication and durability to your fairway and tee box settings.

- ▶ Bronze or aluminum treatments come with a wide variety of rich color backgrounds.
- ▶ Choose rectangular, square or round styles for tees.



Rectangle



Square



Round

ALUMINUM

with two
2 1/2" (6 cm)

zinc-plated, threaded studs

	RECTANGLE 7" x 5" (17.8 cm x 12.7 cm) 2 1/2" (6.4 cm) numbers	RECTANGLE 8" x 6" (20.3 cm x 15.2 cm) 3" (7.6 cm) numbers	ROUND 6" (15.2 cm) diameter 2 1/4" (5.7 cm) numbers	SQUARE 6" x 6" (15.2 cm x 15.2 cm) 2 1/4" (5.7 cm) numbers
Red	300100AL	300106AL	300112AL	300118AL
White	300101AL	300107AL	300113AL	300119AL
Blue	300102AL	300108AL	300114AL	300120AL
Gold	300103AL	300109AL	300115AL	300121AL
Black	300104AL	300110AL	300116AL	300122AL
Green	300105AL	300111AL	300117AL	300123AL

BRONZE

with two
2 1/2" (6 cm)

zinc-plated, threaded studs

	RECTANGLE 7" x 5" (17.8 cm x 12.7 cm) 2 1/2" (6.4 cm) numbers	RECTANGLE 8" x 6" (20.3 cm x 15.2 cm) 3" (7.6 cm) numbers	ROUND 6" (15.2 cm) diameter 2 1/4" (5.7 cm) numbers	SQUARE 6" x 6" (15.2 cm x 15.2 cm) 2 1/4" (5.7 cm) numbers
Red	300100BZ	300106BZ	300112BZ	300118BZ
White	300101BZ	300107BZ	300113BZ	300119BZ
Blue	300102BZ	300108BZ	300114BZ	300120BZ
Gold	300103BZ	300109BZ	300115BZ	300121BZ
Black	300104BZ	300110BZ	300116BZ	300122BZ
Green	300105BZ	300111BZ	300117BZ	300123BZ

CENTENNIAL SERIES PYRAMID YARDAGE MARKERS

- ▶ Available in standard yardages (100,150,200,250).
- ▶ Includes two 2 1/2" (6 cm) zinc-plated, threaded studs.



PYRAMID (ALUMINUM)

9" x 5 1/4" (22.8 cm x 13.3 cm)
2 1/4" (5.7 cm) numbers

PYRAMID (BRONZE)

9" x 5 1/4" (22.8 cm x 13.3 cm)
2 1/4" (5.7 cm) numbers

Red	300124AL	300124BZ
White	300125AL	300125BZ
Blue	300126AL	300126BZ
Gold	300127AL	300127BZ
Black	300128AL	300128BZ
Green	300129AL	300129BZ

GREEN LINE YARDAGE MARKERS

- ▶ Durable Green Line yardage markers in three distinct styles.
- ▶ Includes spike.



	ROUTED ROUND 8" (20.3 cm)	ROUTED RECTANGULAR 8" x 12" (20 cm x 30 cm)	LARGE ROUTED ROUND 15" (38.1 cm)
Red (White numbers)	100080	100070	100090
White (Black numbers)	100081	100071	100091
Blue (White numbers)	100082	100072	100092
Yellow (Black numbers)	100083	100073	100093
Black (White numbers)	100085	100075	100095
Green (White numbers)	100089	100079	100099



SHORT GAME TARGET SYSTEM

- ▶ Economical solution for lessons or special events.
- ▶ Easily adjustable hoop targets expand from 4 to 7 feet (1.2 m x 2.1 m) in diameter.
- ▶ Heavy-duty polyethylene distance markers come in increments of 10.

50000 Short Game Target System
(10 thru 40)

51000 Short Game Target System
(50 thru 80)

50300 Animal Character Decals
(Set of 4 color decals)







CART ID FLAGS

- ▶ Silk-screened ID flags for carts.
- ▶ Also includes heavy-duty squeeze clamps to attach to cart.



28" (71 cm) long 5 1/2"H x 8"W (14 cm x 20 cm) flag

 Ranger	09800
 Players Assistant	09801
 Disabled Symbol	09802
 Marshal	09803
 U.S. Flag	09804

PRO SHOP BALL RACK

- ▶ Handy rack also doubles as pro shop display.
- ▶ Powder-coated, all steel construction.
- ▶ Holds 24 golf balls.

18" (46 cm) high

02250 Pro Shop Ball Rack

02200 Ball Rack Only

Pipe: 28" (71 cm) Base: 14" (36 cm)

02201 Pipe & Base



CADDIE BIBS

- ▶ Comfortable and professional.
- ▶ Cool-weave stretchable polyester mesh.
- ▶ White, removable Velcro banner on back to personalize player name.
- ▶ For a little extra you can customize it with your logo. Contact your local distributor for more information.

29"H x 17"W (74 cm x 43 cm)

Red	73000
-----	-------



PROXIMITY MARKERS

- ▶ Durable. Easy-to-read. Ideal for "Long Drive" and "Proximity" contests.
- ▶ Four markers w/pencil holders and four packs of cards come with each set.
- ▶ 5" x 8" (13 cm x 20 cm) double-sided cards easy to replace.

29"H x 7 1/2"W x 2 1/2"D (74 cm x 19 cm x 6 cm)

10700 Proximity Marker Set

5"W x 8"H (13 cm x 20 cm)

10701 Replacement Card Packs

25 cards per pack

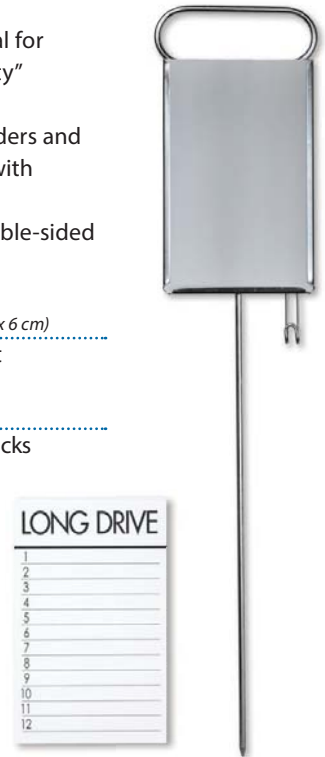

MICROFIBER TWO-PIECE BAG TOWELS

- ▶ No odors. No stains. And UV-resistant.
- ▶ Seven times the absorbency of cotton.
- ▶ Smaller Velcro-attached towel can go with players to the green.
- ▶ Tri-folds to 6" x 24" (15 cm x 61 cm).
- ▶ Priced per dozen.

24"H x 6"W tri-fold (61 cm x 15 cm)

Red	04600
White	04602
Green	04603



FLAGSTICK STAND

- ▶ Perfect for displaying flagsticks indoors.
- ▶ Powder-coated steel for increased durability.
- ▶ Stand can be mounted for temporary or permanent use.



2 1/4"H x 7 1/2" Diameter (6 cm x 19.1 cm)

26800 Flagstick Stand

BALL WASHERS P. 9 - 10

Century Model Case Parts

01203	Lid
01205	Top Gasket
01213	Screw for Top (1)
01214	Hinge Pin
01215	Hinge Clip
01306	Drain Plug Wrench
01317	Set Screw (1)
01320	Towel Snap
01327	Drain Plug Gasket
01328	Drain Plug

Century Model Internal Parts

01245	Nylon Blind End Crank Bushing
01311	Open End Bearing w/ Crank O-Ring and Insert
01321	Cartridge Half (1)
01323	Bumper (1)
01324	Crank O-Ring
01331	Bearing O-Ring
01332	Fiber Gasket (1)
01333	Locknut
01342	Impeller
01346	Impeller Set Screw
01347	Side Brush-New
01348	Race Brush-New

Classic Model Case Parts

01302	Top
01303	Lid
01306	Drain Plug Wrench
01313	Screw for Top (1)
01314	Hinge Pin
01317	Set Screw (1)
01320	Towel Snap
01327	Drain Plug Gasket
01328	Drain Plug
01301	Case-Yellow
01326	Case-Red
01341	Case-Brown
01351	Case-Green
01371	Case-Black
01376	Case-Blue
01396	Case-White
01352	Plastic Overflow Tube

Classic Model Internal Parts

01311	Open End Bearing w/ Crank O-Ring and Insert
01318	Blind End Bearing
01321	Cartridge Half (1)
01323	Bumper (1)

01324	Crank O-Ring
01331	Bearing O-Ring
01332	Fiber Gasket (1)
01333	Locknut
01342	Impeller
01343	Cartridge Assembly (Impeller, 2 Bumpers, Race Brush, 2 Side Brushes, 2 Cartridge Halves)
01344	Crank-Classic Ball Washer
01346	Impeller Set Screw
01347	Side Brush-New
01348	Race Brush-New

Premier & Medalist

01317	Set Screw (1)
01320	Towel Snap
01401	Agitator Assembly-Also Fits Par Aide, R&R and Bayco Ball Washers
01402	Cup & Brush Assembly-Also Fits Par Aide, R&R and Bayco Ball Washers
01405	Lid Gasket (Premier Only)
01406	Stainless Steel Screw for Lid & Cup
01407	Stainless Steel Flat Washer for Lid & Cup
01408	Screw for Lid & Case
01410	Drain Plug
01411	Drain Plug Gasket
01412	Cup with Grommet
01413	Cup Brush Only
01416	Drain Plug Wrench
01514	5/32" Allen Key
01515	3/16" Allen Key
01517	5/16" x 3/4" (M8-1.25) Set Screw
01426	Body-Premier-Red
01427	Cover-Premier-Red
01451	Body-Premier-Green
01452	Cover-Premier-Green
01471	Body-Premier-Black
01472	Cover-Premier-Black
01526	Body-Medalist-Red
01527	Cover-Medalist-Red
01551	Body-Medalist-Green
01552	Cover-Medalist-Green
01571	Body-Medalist-Black
01572	Cover-Medalist-Black

Ashtray

01431	Ashtray Only
01432	Ashtray Holder Only

BUNKER RAKES

P. 11 - 13

Duo & Tour Smooth II Bunker Rakes

11204	Cone Only
11205	54" (137 cm) Natural Aluminum Handle-Duo/ Tour Smooth/Tour Smooth II/Tour Pro w/Grip
11206	7/8" (2.2 cm) Rake Handle Grip-Aluminum Handle
11207	15/16" (2.4 cm) Rake Handle Grip-Composite and Ultralight Handles
11208	Bolt Only
11213	54" (137 cm) Black Composite Handle-Duo/ Old Style Tour Smooth w/Grip
11214	54" (137 cm) Tan Composite Handle-Duo/ Old Style Tour Smooth w/Grip
11216	54" (137 cm) Green Composite Handle-Duo/ Old Style Tour Smooth w/Grip
11217	Sleeve-15/16" (2.4 cm) Composite Handle for Duo
11501	15" (38 cm) Duo-Rake Head
11502	Bolt Assembly (Bolt and Cone)
11503	Anti-Seize Lubricant
11515	54" (137 cm) Yellow Aluminum Handle-Duo/ Tour Smooth/Tour Smooth II/Tour Pro w/Grip
11516	54" (137 cm) Green Aluminum Handle-Duo/ Tour Smooth/Tour Smooth II/Tour Pro w/Grip
11531	64" (163 cm) Gold Aluminum Curved Handle-Duo/ Tour Smooth/Tour Smooth II/Tour Pro w/Grip
11541	64" (163 cm) Green Aluminum Curved Handle-Duo/ Tour Smooth/Tour Smooth II/Tour Pro w/Grip
12205	72" (183 cm) Green Composite Handle-Duo/ Old Style Tour Smooth w/Grip

Tour Pro & Tour Smooth II Bunker Rakes

11200	60" (152 cm) Green Gator Grip Handle- Tour Smooth II/Tour Pro w/Grip
11201	60" (152 cm) Brown Gator Grip Handle- Tour Smooth II/Tour Pro w/Grip
11210	72" (183 cm) Green Gator Grip Handle- Tour Smooth II/Tour Pro w/Grip
11211	72" (183 cm) Brown Gator Grip Handle- Tour Smooth II/Tour Pro w/Grip
11206	7/8" (2.2 cm) Rake Handle Grip
11701	20" (51 cm) Tour Pro-Head
11771	25" (64 cm) Tour Pro-Head
11710	54" (137 cm) Green Composite Handle- Tour Smooth II/Tour Pro w/Grip
11801	15" (38 cm) Tour Smooth II-Head
11810	Mounting Screw-Tour Smooth II/Tour Pro
11811	End Cap-Composite and Gator Grip Handles

Tour Lite, Cart & Economy Bunker Rakes

11601	Economy Rake Head Only
11605	Economy Yellow Wood Rake Handle
11626	Economy Green Wood Rake Handle
11651	Economy Yellow Ultralight Handle
11676	Economy Green Ultralight Handle
12301	Tour-Lite/Cart Rake Head
12305	54" (137 cm) Yellow Ultralight Steel Handle w/Grip
12306	54" (137 cm) Green Ultralight Steel Handle w/Grip

CLUB WASHERS

P. 14

Range Mate Club Washer

01601	Bucket with Lid-Gray Granite
01651	Bucket with Lid-Hunter Green
01602	Brush (each)
01603	Brush Bracket
01605	Wire Stand

Recycled Club Washer

200915	Hand Brush-Club Washers
--------	-------------------------

CUPS

P. 15 - 18

Sand Cup

18401	Inner Shell
18402	Outer Shell

DIVOT MIX STORAGE

P. 19 - 20

Seed & Soil Caddie

18801	Tee Caddie Holder Only-Black
18901	Tee Caddie Holder Only-Green
18802	Tee Caddie Bottle with Lid
18803	Lid Only for Tee Caddie Bottle
18804	Decal Only
18805	Tee Caddie Bottle Only
13104	4-3/4" (12 cm) Spike Only
18951	Cart Caddie Holder
18952	Cart Caddie Bottle with Lid
18953	Cart Caddie Hardware
18954	Lid Only for Cart Caddie Bottle

Junior Seed & Soil Butlers

18931	Container with Lid-Hunter Green
18941	Container with Lid-Black
18942	Usage Decals-Set of 4
18943	Hand Scoop
12985	Low Stand
12986	Wall Mount Bracket

Seed & Soil Butlers

18961	Bucket with Lid-Gray Granite
18971	Bucket with Lid-Hunter Green
18962	Scoop-8 oz. (0.2 L)
01605	Wire Stand

Green Line Divot Mix Storage

200928 Scoop-Green Line Divot Mix Containers

FIXTURES AND BENCHES P. 21

200918BK High Back Bench Leg-Black

200918BR High Back Bench Leg-Brown

200918GN High Back Bench Leg-Green

200919BK Bench Leg-Black

200919BR Bench Leg-Brown

200919GN Bench Leg-Green

200920BK 2" x 4" x 48" (5 cm x 10 cm x 122 cm)
Bench Slat-Black

200920BR 2" x 4" x 48" (5 cm x 10 cm x 122 cm)
Bench Slat-Brown

200920GN 2" x 4" x 48" (5 cm x 10 cm x 122 cm)
Bench Slat-Green

200921BK 2" x 4" x 72" (5 cm x 10 cm x 183 cm)
Bench Slat-Black

200921BR 2" x 4" x 72" (5 cm x 10 cm x 183 cm)
Bench Slat-Brown

200921GN 2" x 4" x 72" (5 cm x 10 cm x 183 cm)
Bench Slat-Green

200922 Bench Hardware-1 Bolt, 1 Washer,
1 Plastic Bolt Cover

FLAGSTICKS P. 30 - 32

26411 Tip

26412 Acorn Nut

EasyMark System

26700 Tap in Flagstick Holder w/ 1/2" (1.3 cm) diameter

26701 Spotter Ring for Tap in Anchor

26725 1/2" x 60" (1.3 cm x 152 cm) Rod-Red

HAZARD MARKERS P. 33 - 35

All-Flex Hazard Marker

15001 All-Flex Hazard/Yardage Marker Sleeve-White

15101 All-Flex Hazard/Yardage Marker Sleeve-Yellow

15201 All-Flex Hazard/Yardage Marker Sleeve-Red

15301 All-Flex Hazard/Yardage Marker Sleeve-Blue

15401 All-Flex Hazard/Yardage Marker Sleeve-Purple

15002 All-Flex Stake

15003 All-Flex Cap

Plastic Hazard Marker Caps and Plug

16154 Marker Cap-White

16155 Marker Cap-Yellow

16156 Marker Cap-Red

16201 Plug with Spike

HOLE CUTTERS AND SHELLS P. 36 - 37

Turfmaster Hole Cutter

28100 Bottom Cage Assembly (Less Blades)

28101 Handle Assembly w/Rubber Grips

Pro II and Magnum Hole Cutters

28204 Wood Handle

28704 Insert Assembly-Pro II

28715 Expeller Assembly-Pro II 4-1/4" (10.8 cm) Hole Cutter

28778 Expeller Assembly-Pro II 6" (15.2 cm) Hole Cutter

28788 Expeller Assembly-Pro II 8" (20.3 cm) Hole Cutter

28907 Insert Assembly-Magnum

28908 Ejector Push Rod-Magnum

28909 Ejector Handle Assembly-Magnum

28915 Expeller Assembly-Magnum 4-1/4" (10.8 cm)
Hole Cutter

MAINTENANCE & TURF TOOLS P. 38 - 43

Debris Rake

11301 21" (53 cm) Head-Debris Rake

11351 9" (23 cm) Head-Debris Rake

11310 Tine w/Nut & Bolt

11355 Fiberglass Handle w/Rubber Grip

Greenskeeper

27201 Body w/Handle

27202 Floor Plate

27203 Spring

27204 Spring Seat

27205 Finger (1)

27206 Roll Pin (1)

27207 Snap Ring (1)

27208 Handle

Turf Doctor

29201 Replacement Blade (each)

Levelawn, Bunker Debris Sieve

29301 6' (1.8 m) Wood Handle

29302 30" (76 cm) Levelawn Head w/Hardware

29326 1/2" (1.3 cm) Bunker Sieve Head

29351 1/4" (0.6 cm) Bunker Sieve Head

29352 Bunker Debris Sieve Bracket Only

29377 36" (91 cm) Levelawn Head w/Hardware

Irrigation Head Trimmer

29602 Cross Bracket

29603 Blade Assembly Hardware

Hand Aerifier

29802	Plastic Mounting Base-Aerifier
29804	Solid Tine-Aerifier
29806	Handle Weldment-Aerifier
29807	Core Collector-Aerifier
29809	Hollow Tine-Aerifier

Du-Whipper

34201	Handle Section with Metal Fitting
34202	Middle Section
34203	Tip Section
34204	Metal Cap for Handle
34205	Rubber Cap for Tip

Drag Brush

52003	Draw Bar
52004	Draw Bar Bearing Pin
52007	Hair Pin
52008	5/16" x 2" (M8-1.25 x 50 mm) Eye Bolt
52009	5/16" x 1-1/2" (M8-1.25 x 38 mm) Carriage Bolt
52010	5/16" (M8) S.A.E. Flat Washer
52012	5/16" (M8-1.25) Hex Nut
52014	Channel for Drag Brush (each)-4 Required
52015	End Angle
52016	Center Angle
52017	Hardware Package

Drag Brush Extension

52014	Channel for Extension (each)-4 Required
52015	End Angle
52057	Hardware Package
52067	Hinge (each)

Coco Fiber Drag Mat

53001	Coco Mat Only-4' x 6' (1.2 m x 1.8 m)
53002	77" (196 cm) Steel Drag Bar Tube
53003	Straight Link Coil Chain 10' (3.0 m) Length
53004	77" (196 cm) Steel Drag Bar Flat
53051	Coco Mat Only-3' x 5' (0.9 m x 1.5 m)
53052	59" (150 cm) Steel Drag Bar Tube
53054	59" (150 cm) Steel Drag Bar Flat

Magnum Maintenance and Landscape Rakes

71125	24" (61 cm) Head-Straight Tooth
71131	30" (76 cm) Head-Straight Tooth
71137	36" (91 cm) Head-Straight Tooth
71143	42" (107 cm) Head-Straight Tooth
71225	24" (61 cm) Head-Sifting Tooth
71231	30" (76 cm) Head-Sifting Tooth
71237	36" (91 cm) Head-Sifting Tooth
71243	42" (107 cm) Head-Sifting Tooth

71150	66" (168 cm) Straight Handle
71151	Gusset Braces (pair)
71152	Twist Braces (pair)
71153	1/4" x 1-3/4" (M6-1.0 x 45 mm) Bolt
71154	1/4" (M6-1.0) Nylon Lock Nut
71155	1/4" x 5/8" (M6-1.0 x 16 mm) Bolt
71156	Handle Grip

Magnum Roller Squeegees

71326	24" (61 cm) Roller Frame Assembly
71338	36" (91 cm) Roller Frame Assembly
71350	48" (122 cm) Roller Frame Assembly
71351	57-1/2" (146 cm) Bent Handle
71352	5/16" x 5/8" (M8-1.25 x 16 mm) Stainless Steel Bolt
71353	5/16" (M8) Stainless Steel Lock Washer
71354	1/2" (1.3 cm) Stainless Steel Axle
71355	1/4" x 1-1/2" (M6-1.0 x 38 mm) Bolt for Hanging Hook
71356	Hanging Hook
71151	Gusset Braces (pair)
71152	Twist Braces (pair)
71153	1/4" x 1-3/4" (M6-1.0 x 45 mm) Bolt
71154	1/4" (M6-1.0) Nylon Lock Nut
71155	1/4" x 5/8" (M6-1.0 x 16 mm) Bolt
71156	Handle Grip

Magnum Lutes

71425	24" (61 cm) Head
71437	36" (91 cm) Head
71150	66" (168 cm) Straight Handle
71151	Gusset Braces (pair)
71152	Twist Braces (pair)
71153	1/4" x 1-3/4" (M6-1.0 x 45 mm) Bolt
71154	1/4" (M6-1.0) Nylon Lock Nut
71155	1/4" x 5/8" (M6-1.0 x 16 mm) Bolt
71156	Handle Grip

Magnum Spiked Roller

71709	8" (20 cm) Roller Head
71717	16" (41 cm) Roller Head
71710	8" (20 cm) Frame Assembly
71718	16" (41 cm) Frame Assembly
71720	3/8" (1.0 cm) Stainless Steel Axle
71151	Gusset Braces (pair)
71153	1/4" x 1-3/4" (M6-1.0 x 45 mm) Bolt
71154	1/4" (M6-1.0) Nylon Lock Nut
71155	1/4" x 5/8" (M6-1.0 x 16 mm) Bolt
71156	Handle Grip
71351	57-1/2" (146 cm) Bent Handle
71352	5/16" x 5/8" (M8-1.25 x 16 mm) Stainless Steel Bolt
71353	5/16" (M8) Stainless Steel Lock Washer

Magnum Double Duty Rake

71837	36" (91 cm) Rake Head
71150	66" (168 cm) Straight Handle
71151	Gusset Braces (pair)
71152	Twist Braces (pair)
71153	1/4" x 1-3/4" (M6-1.0 x 45 mm) Bolt
71154	1/4" (M6-1.0) Nylon Lock Nut
71155	1/4" x 5/8" (M6-1.0 x 16 mm) Bolt
71156	Handle Grip

Magnum General Purpose Broom

72101	24" (61 cm) Broom Head with Adaptor Plate
71151	Gusset Braces (pair)
71153	1/4" x 1-3/4" (M6-1.0 x 45 mm) Bolt
71154	1/4" (M6-1.0) Nylon Lock Nut
71155	1/4" x 5/8" (M6-1.0 x 16 mm) Bolt
71156	Handle Grip
71351	57-1/2" (146 cm) Bent Handle

Magnum Maximum Duty Broom

72126	28" (71 cm) Head
72127	27-3/4" (70 cm) Bristle
72128	End Cap
72129	#8 X 5/8" (M4-0.7 x 16 mm) Screw
71151	Gusset Braces (pair)
71152	Twist Braces (pair)
71153	1/4" x 1-3/4" (M6-1.0 x 45 mm) Bolt
71154	1/4" (M6-1.0) Nylon Lock Nut
71155	1/4" x 5/8" (M6-1.0 x 16 mm) Bolt
71156	Handle Grip
71351	57-1/2" (146 cm) Bent Handle

Magnum Monster Broom

72151	Broom Head
72152	40" (102 cm) Straight Handle
72153	Curved Handle with Grip
72154	83-3/4" (213 cm) Bristle
71153	1/4" x 1-3/4" (M6-1.0 x 45 mm) Bolt
71154	1/4" (M6-1.0) Nylon Lock Nut
71355	1/4" x 1-1/2" (M6-1.0 x 38 mm) Bolt for Hanging Hook
71356	Hanging Hook
72128	End Cap
72129	#8 X 5/8" (M4-0.7 x 16 mm) Screw

Magnum Straight Edge Squeegee

72225	24" (61 cm) Rubber Blade
72237	36" (91 cm) Rubber Blade
72226	24" (61 cm) Head
72238	36" (91 cm) Head
72227	24" (61 cm) Head Strip
72239	36" (91 cm) Head Strip

72250	1/4" x 3/4" (M6-1.0 x 18 mm) Bolt
72251	1/4" (M6-1.0) K-Lock Nut
71150	66" (168 cm) Straight Handle
71151	Gusset Braces (pair)
71152	Twist Braces (pair)
71153	1/4" x 1-3/4" (M6-1.0 x 45 mm) Bolt
71154	1/4" (M6-1.0) Nylon Lock Nut
71155	1/4" x 5/8" (M6-1.0 x 16 mm) Bolt
71156	Handle Grip

Tuffork

71905	1/4" X 2" (M6-1.0 x 50 mm) Bolt
71154	1/4" (M6-1.0) Nylon Lock Nut

Magnum Spring Brace Rake

72401	Head-Magnum Spring Brace Rake
72402	Handle-Magnum Spring Brace Rake

MARKING PAINT P. 44 - 45

E-ZEE White Tool

55601	O-Rings (pair)
55602	Rubber Washer

PRACTICE GREEN MARKERS P. 46 - 49

Practice Green Targets

20120	Knob-Black
-------	------------

Practice Green Markers and Flags

Specify numbers when ordering

20392	Pennant W/R Single w/Rod & Base
20492	Pennant W/Grn Single w/Rod & Base
20592	Pennant Black/Yel. Single w/Rod & Base
20393	Pennant W/R Head & Rod
20493	Pennant W/Grn Head & Rod
20593	Pennant Black/Yel. Head & Rod
20612	Nylon Flag-Small Tube-Red/White Single
20712	Nylon Flag-Small Tube-White/Red Single
20812	Nylon Flag-Small Tube-Yellow/Black Single
20692	Nylon Flag-Small Tube-R/W Single w/Rod, Base & Knob
20792	Nylon Flag-Small Tube-W/R Single w/Rod, Base & Knob
20892	Nylon Flag-Small Tube-Y/B Single w/Rod, Base & Knob
20594	Nylon Flag-Small Tube-Plain Green Single
20694	Nylon Flag-Small Tube-Plain Red Single
20794	Nylon Flag-Small Tube-Plain White Single
20894	Nylon Flag-Small Tube-Plain Yellow Single
20994	Nylon Flag-Small Tube-Plain Blue Single
20596	Nylon Flag-Large Tube-Plain Green Single

20696	Nylon Flag-Large Tube-Plain Red Single
20796	Nylon Flag-Large Tube-Plain White Single
20896	Nylon Flag-Large Tube-Plain Yellow Single
20996	Nylon Flag-Large Tube-Plain Blue Single
20912	Nylon Flag-Small Tube-Black/White Checkered Single
20922	Nylon Flag-Small Tube-Red/White Checkered Single
20932	Nylon Flag-Small Tube-Black/Yellow Checkered Single
20942	Nylon Flag-Small Tube-Green/White Checkered Single
20917	Nylon Flag-Large Tube-Black/White Checkered Single
20927	Nylon Flag-Large Tube-Red/White Checkered Single
20937	Nylon Flag-Large Tube-Black/Yellow Checkered Single
20947	Nylon Flag-Large Tube-Green/White Checkered Single
20987	Nylon Flag-Small Tube-Sewn U.S. Flag Replica Single
25712	250 Denier Practice Green Flag-Small Tube-White-Single
25722	250 Denier Practice Green Flag-Large Tube-White-Single

RANGE EQUIPMENT & ACCESSORIES**P. 50 - 56****Magnum Harvester Ball Picker**

80600	Back Gang Assembly
81200	A-Frame
81300	Gang Pin Assembly
81501	Spacer-Drum Assembly
81503	Plastic Disc-.76" Dia. ID
81600	Hub Weldment-Drum Assembly
81700	Semi-Pneumatic Tire with Hub
81900	Coated Gang with Bushings
82000	Gang Drum Assembly
82001	Plastic Disc-1.02" Dia. ID
82002	Axle Shaft
82100	Tie Rod Weldment-10 Disc
82200	Tie Rod Weldment-9 Disc
82300	Axle Tube Weldment
82400	Pivot Bracket
82500	Push Frame
82600	Left Arm Extension
82700	Right Arm Extension
83101	Bushing
83102	Pin Collar
83103	Pivot Pin
83107	Extend Pin-Left Arm Extension
83111	Gang Drum Spacer
83115	Compression Spring

83116	Pillow Block Bearing
83117	Double-Seal O-Ring
83118	1-1/2" (3.8 cm) Square End Cap
83120	1-1/4" (3.2 cm) Square Cap Plug
83121	Rubber Tip-Basket
83122	1" x 2" (3 cm x 5 cm) Rectangular Plug-Black
83123	5/16" x 1-1/4" Lynch Pin
83124	Pull Pin, Pivot Bracket
83200	Front Gang Pin

Magnum Jr. Harvester

85201	Handle
85202	Main Frame
85203	Front Axle
85204	Octagon Stem Caster
85205	Plastic Disc-.76" Dia. ID
85206	Drum Assembly

Magnum Scrub-Pro

83116	Pillow Block Bearing
86100	Main Frame-Domestic
87100	Main Frame-Export
86200	Drum Weldment
86300	Motor Hood-Domestic
87300	Motor Hood-Export
86400	Tub-Top & Bottom
86401	Liner/Guide Set
86402	Rubber Liner-1-3/4" x 12-7/8" (4 cm x 33 cm)
86403	Rubber Liner-1-3/4" x 19-1/2" (4 cm x 50 cm)
86404	Rubber Liner-1-3/4" x 20-3/8" (4 cm x 52 cm)
86405	Rubber Latch
86406	Exit Chute
86500	Wire Basket
86600	Gear Motor-AC-40 RPM-Domestic
86703	Coupler Set
86800	Drum & Brush Assembly
86850	Coiled Brush
86900	PVC Drain Assembly
87600	Gear Motor-AC-40 RPM-Export

Range Marking Pole

09797	Cap-Range Marking Pole
-------	------------------------

Range Banner Frame Assembly Kit

31001	Pressure Elbow
31002	Frame/Leg-20" (51 cm)
31003	Pressure Tee
31004	Frame-41-1/2" (105 cm)
31006	Underground Socket

Vertical Range Flags

60095	3/8"-24 (M10-1.25) Nylon Insert Hex Flange Locknut
60096	Rod-Vertical Range Flag
60051	Vertical Range Flag Only-Yellow/Black-50
60101	Vertical Range Flag Only-Yellow/Black-100
60151	Vertical Range Flag Only-Yellow/Black-150
60201	Vertical Range Flag Only-Yellow/Black-200
60251	Vertical Range Flag Only-Yellow/Black-250
60511	Vertical Range Flag Only-Red
60521	Vertical Range Flag Only-White
60531	Vertical Range Flag Only-Yellow
60541	Vertical Range Flag Only-Orange
60551	Vertical Range Flag Only-Medium Blue
60561	Vertical Range Flag Only-Green
60571	Vertical Range Flag Only-Black

Green Line Recycle Bag Stand

200914	Cup Holder-Bag Stands
--------	-----------------------

Yardage Easel

200923	Aluminum Slider-Yardage Easels
200924	Easel Numbers-2" x 3" (5 cm x 8 cm)- Black on White (each)

SIGNS

P. 60 - 66

Tee Markers and Signs

05305	Aluminum Button Only-Saf-T Marker
05404	5" (13 cm) Stake-TurfStone Sign, Broken Tee Caddy
05804	3-1/2" (9 cm) Stake-TurfStone Tee Marker
07006	6" x 8" (15 cm x 20 cm) TurfStone Sign Gray Granite-Plain
07106	9" x 12" (23 cm x 30 cm) TurfStone Sign Gray Granite-Plain
08429	6" x 12" (15 cm x 30 cm) Bracket w/Stake
09104	5-1/2" (14 cm) Stake
10014	9-1/2" (24 cm) Stake
10331	Aluminum Sign 12" x 12" (30 cm x 30 cm) Plain White
10332	Dry Erase Marker-Black

Green Line

200916	1/4" x 4-1/2" Spike-Signs/Tee Markers
200917	3/8" x 8" Spike-Stakes

Decals

09161	Fairway Sign-Carts on Path Only- Green/White (each)
09162	Fairway Sign-Drop Area-Green/White (each)
09162E	Fairway Sign-Zona de Dropaje-Green/White (each)
09162F	Fairway Sign-Dropping Zone-Green/White (each)
09163	Fairway Sign-Ground Under Repair- Green/White (each)

09163D	Fairway Sign-Boden in Ausbesserung- Green/White (each)
--------	---

09163E	Fairway Sign-Terreno en Reparacion- Green/White (each)
--------	---

09163F	Fairway Sign-Terrain en Reparation- Green/White (each)
--------	---

09164	Fairway Sign-Keep Carts 30' From Green- Green/White (each)
-------	---

09165	Fairway Sign-No Carts-Green/White (each)
-------	--

09166	Fairway Sign-Please Repair Ball Marks- Green/White (each)
-------	--

09166D	Fairway Sign-Bitte Pitchmarks Ausbessern- Green/White (each)
--------	---

09166E	Fairway Sign-Reparare Las Marcas de Pelota Por Favor-Green/White (each)
--------	--

09166F	Fairway Sign-Relevez vos Pitches- Green/White (each)
--------	---

09167	Fairway Sign-Replace Divots-Green/White (each)
-------	--

09167D	Fairway Sign-Bitte Divots Zurucklegen- Green/White (each)
--------	--

09167E	Fairway Sign-Reponga Las Chuleta Por Favor- Green/White (each)
--------	---

09167F	Fairway Sign-Replacez vos Divos S'il Vous Plait- Green/White (each)
--------	--

09181	Fairway Sign-Carts on Path Only-Green/Tan (each)
-------	--

09182	Fairway Sign-Drop Area-Green/Tan (each)
-------	---

09183	Fairway Sign-Ground Under Repair- Green/Tan (each)
-------	---

09184	Fairway Sign-Keep Carts 30' From Green- Green/Tan (each)
-------	---

09185	Fairway Sign-No Carts-Green/Tan (each)
-------	--

09186	Fairway Sign-Please Repair Ball Marks- Green/Tan (each)
-------	--

09187	Fairway Sign-Replace Divots-Green/Tan (each)
-------	--

10001	15" (38 cm) Arrow-Carts-Yellow/Black (pair)
-------	---

10003	15" (38 cm) Arrow-Next Tee-Yellow/Black (pair)
-------	--

10005	15" (38 cm) Arrow-Golf Cars-Yellow/Black (pair)
-------	---

10051	15" (38 cm) Arrow-Carts-Green/White (pair)
-------	--

10051D	15" (38 cm) Arrow-Caddywagen- Green/White (pair)
--------	---

10051E	15" (38 cm) Arrow-Carritos-Green/White (pair)
--------	---

10051F	15" (38 cm) Arrow-Chariots-Green/White (pair)
--------	---

10053	15" (38 cm) Arrow-Next Tee-Green/White (pair)
-------	---

10053D	15" (38 cm) Arrow-Nachster Abschlag- Green/White (pair)
--------	--

10053E	15" (38 cm) Arrow-Proximo Tee- Green/White (pair)
--------	--

10053F	15" (38 cm) Arrow-Depart Suivant- Green/White (pair)
--------	---

10055	15" (38 cm) Arrow-Golf Cars-Green/White (pair)
10055D	15" (38 cm) Arrow-Golfwagen-Green/White (pair)
10055E	15" (38 cm) Arrow-Carritos de Golf-Green/White (pair)
10055F	15" (38 cm) Arrow-Voitures de Golf-Green/White (pair)
10057	15" (38 cm) Arrow-No.____Tee-Green/White (pair)
10061	15" (38 cm) Arrow-Buggies-Green/White (pair)
10063	15" (38 cm) Arrow-Trolleys-Green/White (pair)
10071	15" (38 cm) Arrow-Carts-Green/Tan (pair)
10073	15" (38 cm) Arrow-Next Tee-Green/Tan (pair)
10075	15" (38 cm) Arrow-Golf Cars-Green/Tan (pair)
10077	15" (38 cm) Arrow-No.____Tee-Green/Tan (pair)
10101	11" (28 cm) Arrow-Carts-Yellow/Black (pair)
10103	11" (28 cm) Arrow-Next Tee-Yellow/Black (pair)
10105	11" (28 cm) Arrow-Golf Cars-Yellow/Black (pair)
10151	11" (28 cm) Arrow-Carts-Green/White (pair)
10151D	11" (28 cm) Arrow-Caddywagen-Green/White (pair)
10151E	11" (28 cm) Arrow-Carritos-Green/White (pair)
10151F	11" (28 cm) Arrow-Chariots-Green/White (pair)
10153	11" (28 cm) Arrow-Next Tee-Green/White (pair)
10153D	11" (28 cm) Arrow-Nachster Abschlag-Green/White (pair)
10153E	11" (28 cm) Arrow-Proximo Tee-Green/White (pair)
10153F	11" (28 cm) Arrow-Depart Suivant-Green/White (pair)
10155	11" (28 cm) Arrow-Golf Cars-Green/White (pair)
10155D	11" (28 cm) Arrow-Golfwagen-Green/White (pair)
10155E	11" (28 cm) Arrow-Carritos de Golf-Green/White (pair)
10155F	11" (28 cm) Arrow-Voitures de Golf-Green/White (pair)
10161	11" (28 cm) Arrow-Buggies-Green/White (pair)
10163	11" (28 cm) Arrow-Trolleys-Green/White (pair)
10171	11" (28 cm) Arrow-Carts-Green/Tan (pair)
10173	11" (28 cm) Arrow-Next Tee-Green/Tan (pair)
10175	11" (28 cm) Arrow-Golf Cars-Green/Tan (pair)

SPIKE KLEENERS**P. 67 - 68****Scrusher**

14101	Frame
14104	Screw-Side Brush (1)

Boot Cleaner

14210	Steel Spike Brush Only-Boot Cleaner
14211	Alternative Spike Brush Only-Boot Cleaner

Spike Kleener

14301	Base Only-Red
14401	Base Only-Green
14701	Base Only-Black
14203	3-1/2" (9 cm) Spike (1)
14204	Screw (1)

TEE CONSOLES**P. 69 - 73****Console and Stand**

36108	Console Spike Kleener Base-Black
36156	Console Spike Kleener-Alternative Spikes-Gray
36201	Tripod Base Only-Black
36202	Console Spike Kleener Bracket Only-Black
36204	Junior Console Post Assembly Only-Black
36205	18" (46 cm) Ground Anchor
36229	Ball Washer Stand Hardware
36234	34" (86 cm) Post Only for Tradition Console-Black
36280	Aluminum Base Only for Tradition Console-Black
14203	3-1/2" (9 cm) Spike (1)

TurfStone Consoles and Tee Signs

65206	Ball Washer Bracket-TurfStone Posts
65207	Litter Caddie Bracket-TurfStone Posts
65208	Sign Bracket Only for Optional Post Mount
65313	Bracket Only 6" x 8" (15 cm x 20 cm) Donor Sign
67504	TurfStone Junior Post Assembly Only-Black
36201	Tripod Base Only-Black
36205	18" (46 cm) Ground Anchor

TEE MARKERS**P. 74 - 78****Broken Tee Caddie**

19002	Decal-Broken Tee-White
19004	Decal-Broken Tee-Black
05404	5" (13 cm) Stake

TRASH CONTAINERS**P. 80 - 82****Litter Mate**

12826	Trash Container Only-Red
12851	Trash Container Only-Hunter Green
12871	Trash Container Only-Black
12980	Lid-Trash Opening
12981	Lid-Solid (no opening)
12982	Hoop Frame
12983	Pole Mounting Bracket
12984	Back Clamp
12985	Low Stand
12986	Wall Mount Bracket
12987	Double Hardware Kit
12988	Single Hardware Kit

Litter Caddie

13002	30 Gallon (114 L) Base Only
13004	12" (30 cm) Spike Only-20 (76 L) or 30 (114 L) Gallon
13104	4-3/4" (12 cm) Spike Only-9 Gallon (34 L)
13105	10" (25 cm) Long Spike Only-9 Gallon (34 L)
13202	9 Gallon (34 L) Base Only
13851	Nylon Ties-Black-9 Gallon (34 L) Litter Caddie Liner
13902	20 Gallon (76 L) Stainless Steel Base Only

Green Line Accessories

200903	Square Trash Liner-16 Gallon (61 L)
200904	Square Trash Liner-26 Gallon (98 L)
200905	Round Trash Liner-3.5 Gallon (13 L)
200906	Round Trash Liner-5 Gallon (19 L)
200908	Round Trash Liner-20 Gallon (76 L)
200909	Round Trash Liner-32 Gallon (121 L)
200910	Round Trash Container-10 Gallon (38 L)
200911	Round Trash Container-20 Gallon (76 L)
200912	Round Trash Container-32 Gallon (121 L)
200913	Round Trash Container-44 Gallon (167 L)
200925BK	Lid-3.5 Gallon Round Slatted-Black
200925BR	Lid-3.5 Gallon Round Slatted-Brown
200925GN	Lid-3.5 Gallon Round Slatted-Green
200926BK	Lid-5 Gallon Round Slatted-Black
200926BR	Lid-5 Gallon Round Slatted-Brown
200926GN	Lid-5 Gallon Round Slatted-Green
200927BK	Lid-10 Gallon Round Slatted-Black
200927BR	Lid-10 Gallon Round Slatted-Brown
200927GN	Lid-10 Gallon Round Slatted-Green

WATER STATIONS

P. 83 - 85

Kooler-Aid

40126	Kooler-Aid Top-Red
40151	Kooler-Aid Top-Green
40171	Kooler-Aid Top-Black
40200	Kooler-Aid Stand-Black
36201	Tripod Base Only-Black
40204	Post Assembly Only-Black
40205	Kooler-Aid Tray-Black
40129	Kooler-Aid Top Hardware
40177	Ball Knob
40229	Kooler-Aid Stand Hardware
45305	Cup Dispenser Mounting Bracket
45315	Spigot for Plastic Cooler
45605	Lid for Cup Dispenser

Junior Kooler-Aid

47126	Jr. Kooler-Aid Top-Red
47151	Jr. Kooler-Aid Top-Green
47171	Jr. Kooler-Aid Top-Black
47200	Jr. Kooler-Aid Stand-Black
36201	Tripod Base Only-Black
40204	Post Assembly Only-Black
47205	Jr. Kooler-Aid Tray-Black

Water Purification System

49001	Purification Cartridge
49002	Pump Assembly, Complete
49003	Ice Guard
49004	Cooler Gasket, Gasket Stop, and Connector Tube Kit

YARDAGE MARKERS

P. 86 - 88

09311	PVC Marker Decal-Red/White 100
09321	PVC Marker Decal-Clear/Black 150
09331	PVC Marker Decal-Blue/White 200
09341	PVC Marker Decal-Yellow/Black 250
09361	Decal 1-Stripe German-Style Marker
09362	Decal 2-Stripe German-Style Marker
09363	Decal 3-Stripe German-Style Marker

Fairway Marking Poles

09701	Striped Pole Only (each)
09702	Cap for Fairway Marking Pole
31006	Underground Socket

PROLINE

P. 89 - 90

Ball Rack

02202	14" (36 cm) Base Only
02203	Pipe Only
02252	8" (20 cm) Base Only

Golf Cart Flag Identification System

09419	5/16" (0.8 cm) Acorn Nut-Black
09810	Cart Flag Red/White "Ranger"
09811	Cart Flag White/Red "Players Assistant"
09812	Cart Flag Blue/White Disabled Symbol
09813	Cart Flag Red/White "Marshal"
09820	White Rod for Cart Flags
09830	Spring Clamp Assembly for Cart Flags
09831	Threaded Aluminum Block
20987	Cart Flag-Sewn U.S. Flag

Short Game Target System

50010	Short Game 10 Yard Sign
50020	Short Game 20 Yard Sign
50030	Short Game 30 Yard Sign
50040	Short Game 40 Yard Sign
50200	Short Game Target Hoop
50201	Sign Adapter-Short Game Target
50202	Spike/Tube Assembly-Short Game Target
50203	3/4" (1.9 cm) Tubing-Short Game Target
51050	Short Game 50 Yard Sign
51060	Short Game 60 Yard Sign
51070	Short Game 70 Yard Sign
51080	Short Game 80 Yard Sign

2015

STANDARD GOLF COMPANY

6620 Nordic Drive
P.O. Box 68
Cedar Falls, Iowa 50613, USA
phone: 319-266-2638
fax: 319-266-9627

email: info@standardgolf.com
www.standardgolf.com



Standard Golf products are available worldwide through a network of outstanding Distributors.

For the name of the Distributor nearest you, contact us toll-free at 1-800-553-1707.

DISTRIBUTED BY

WARRANTY: Standard Golf Company warrants its products to be free from defects in materials and workmanship within a period of one year from the date of purchase. Standard Golf's sole responsibility under this warranty shall be to repair, replace or refund the price of the defective product or component. All such repairs, refunds and replacements are subject to such rules, terms and conditions as Standard Golf may promulgate from time to time.

DISCLAIMER OF OTHER WARRANTIES: The foregoing limited warranty is in lieu of all other warranties, expressed or implied, including merchantability or fitness for a particular purpose. In no event shall Standard Golf be liable for any indirect, consequential or special damages of any nature whatsoever.

IMPORTANT NOTICE: United States Golf Association' logos appearing in this catalog are for illustrative purposes only. They do not imply endorsement by the owners of the designs.

The use of the word 'tour' in connection with any product in this catalog does not imply a relationship with, or an endorsement by PGA TOUR, Inc.

Sizes, weights, dimensions and descriptions given in this catalog are nominal only, and may change slightly from time to time due to changes in materials and production methods. Colors are approximate, and may change slightly among different products.

© 2015 Standard Golf Company

Printed in USA



The photography in this catalog was taken at Beaver Hills Country Club, Des Moines Golf & Country Club, Quarry Oaks Golf Course and the Country Club in Lincoln. We at Standard Golf greatly appreciate the opportunity to showcase our products on these fine courses, and we would like to thank the following: Superintendent Rick Tegtmeier and Golf Pro Scott Howe – Des Moines Golf & Country Club; Superintendent Ken Cuddy and Golf Pro Joe Sutter – Quarry Oaks; Superintendent Ben Messerly – the Country Club of Lincoln; and Superintendent Josh Petersen and Golf Pro Brad Clark – Beaver Hills Country Club.

STANDARD GOLF IS PROUD TO SUPPORT THESE INDUSTRY ASSOCIATIONS:



Silver Partner • Golf Course
Superintendents
Association of America



National Golf
Course Owners
Association



Canadian Golf
Superintendents
Association



Iowa Golf Course
Superintendents
Association



National
Golf
Foundation



Golf Coaches
Association of
America